



RG-S3760

©2009



RGOS® RGNOS®



锐捷®

RGOS®10.3(4b3)

```
[] []  
{x|y|...}  
[x|y|...]  
//
```

3.

r

/

/

1)

2)

```
'  
'  
'  
'      no  default  
'      CLI  
'  
'  
'      CLI  
'      CLI
```

?

User EXEC

show

Privileged EXEC

“Ruijie”



Help	
abbreviated-command-entry?	Ruijie# di? dir disable
abbreviated-command-entry<Tab>	Ruijie# show conf<Tab> Ruijie# show configuration
?	Ruijie# show ?
command keyword ?	Ruijie(config)# snmp-server community ? WORD SNMP community string

show configuration

Ruijie# **show conf**

no default

no

no

no shutdown

shutdown

no

default

default

default

no

default

no

default

CLI

CLI

CLI

% Ambiguous command "show c"		
% Incomplete command		
% Invalid input detected at '^' marker	^	

Ctrl-P	
Ctrl-N	Ctrl-P

r

VT100

5T01D> Q1k@
Ctrl-A

	Ctrl-B	
	Ctrl-F	

	Ctrl-E
--	--------

mac-address-table static

20

\$

20

```
mac-address-table static 00d0.f800.0c0c vlan 1
interface
$static 00d0.f800.0c0c vlan 1 interface fastEthernet
$static 00d0.f800.0c0c vlan 1 interface fastEthernet 0/1
```

Ctrl-A

\$

```
-address-table static 00d0.f800.0c0c vlan 1 interface $
```

Ruijie# show <i>any-command</i> exclude <i>regular-expression</i>	show
Ruijie# show <i>any-command</i> include <i>regular-expression</i>	show



Ruijie# configure terminal	

mode
 CLI **config**
 exec
 interface

Ruijie(config)# **privilege mode [all] {level**
level | reset} command-string

all
level level 0
 15 **level 1**
level 15

enable/disable
command-string

R>

Ruijie(config)# **privilege mode [all] {level**
level | reset} command-string

in reload after a time interval
<cr>

reload

Ruijie# **configure terminal**

Ruijie(config)# **privilege exec all reset reload**

Ruijie(config)# **end**

1

Ruijie# **disable 1**

Ruijie> EXEC [4721] > 6<35421FF514E2T3DF183B3E20104B80elc6C820.500145EE459B05532A

% Unrecognized command.

line

TELNET

line

line 14.F180.0E303-0.10f /TT4740.1 T.8 1(w)2T80.0E.101FF4C52 Tc/TT4740.14.F11(w)2T 0.4

AAA

RADIUS

RADIUS

RADIUS

AAA

AAA

Ruijie(config)# username <i>name</i> [password <i>password</i> password <i>encryption-type encrypted password</i>]	
Ruijie(config)# username <i>name</i> [privilege <i>level</i>]	

Ruijie(config-line)# login local	AAA
Ruijie(config-line)# login authentication { default <i>list-name</i> }	AAA AAA Radius AAA

/

AAA

Radius

AAA

)

() (

Ruijie# clock set <i>hh:mm:ss month day year</i>	

2003-6-20 10:10:12

Ruijie# **clock set** 10:10:12 6 20 2003 //

Ruijie# **show clock** //

10:10:15 UTC Fri, Jun 20, 2003

show clock

Ruijie# **sh clock** //

clock: 2003-5-20 11:11:34

calendar

clock update-calendar



/

at

200

,

125 **reload** (2005-01-10
12:00)

```
Ruijie# reload in 125 test //
Ruijie# reload in 2:5 test //
Ruijie# show reload //
System will reload in 7485 seconds.
```

reload

no hostname
RGOS

```
Ruijie# configure terminal //  
Ruijie(config)# hostname RGOS // RGOS  
RGOS(config)# //
```

32 32
prompt EXEC

Ruijie# prompt string	32
	32

no prompt

banner

--	--

<pre>Ruijie(config)# banner motd c message c</pre>	<pre>(message of the day) c ('&') 255</pre>
---	---

no banner motd

(#)

“Notice: system will shutdown on July 6th.”

```
Ruijie(config)# banner motd # //
Enter TEXT message. End with the character '#'.
Notice: system will shutdown on July 6th.# //
Ruijie(config)#
```

<pre>Ruijie(config)# banner login c message c</pre>	<pre> c ('&') 255</pre>

no banner login

(#)

“Access for authorized users only. Please enter your password.”

```
Ruijie(config)# banner login # //
Enter TEXT message. End with the character '#'.
Access for authorized users only. Please enter your password.
# //
Ruijie(config)#
```

C:\>telnet 192.168.65.236

Notice: system will shutdown on July 6th.

Access for authorized users only. Please enter your password.

User Access Verification

Password:

“Notice: system will shutdown on July 6th.”
authorized users only. Please enter your password.”

“Access for

Ctrl

Boot

Ruijie# show version	

Ruijie# show version devices	

Ruijie# show version slots	
-----------------------------------	--

Console

Ruijie(config-line)# speed speed	bps 9600 19200 38400 57600 115200 9600

57600 bps

```
Ruijie# configure terminal //
Ruijie(config)# line console 0 //
Ruijie(config-line)# speed 57600 // 57600
Ruijie(config-line)# end //
Ruijie# show line console 0 //
CON  Type  speed  Overruns
* 0  CON  57600  0
Line 0, Location: "", Type: "vt100"
Length: 25 lines, Width: 80 columns
Special Chars: Escape Disconnect Activation
                ^^x  none      ^M
Timeouts:      Idle EXEC  Idle Session
                never     never
History is enabled, history size is 10.
Total input: 22 bytes
Total output: 115 bytes
```

Data overflow: 0 bytes
 stop rx interrupt: 0 times
 Modem: READY

telnet

Telnet TCP/IP

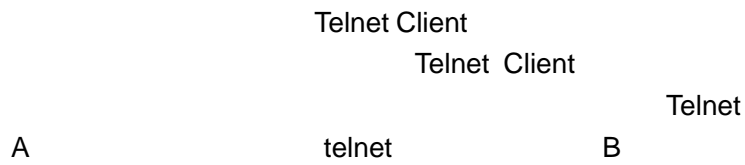

1

Telnet Client

telnet

Ruijie# telnet <i>host-ip-address</i>	telnet IP

Telnet ip
 192.168.65.119
 Ruijie# **telnet** 192.168.65.119 // telnet

LINE

Ruijie(config-line)# exec-timeout 20	LINE

LINE

no exec-timeout

LINE

```
Ruijie# configure terminal //  
Ruijie# line vty 0 // LINE  
Ruijie(config-line)# exec-timeout 20 // 20min
```

LINE

LINE

Ruijie(config-line)# session-timeout 20	LINE

LINE

no exec-timeout

LINE

```
Ruijie# configure terminal //
```

```
Ruijie(config)# line vty 0 // LINE
Ruijie(config-line)# session-timeout 20 // 20min
```

CLI

Ruijie# execute {[flash:] filename}	

line_rcms_script.text

Telnet

SSH Server/Telnet Server/Web Server

Ruijie(Config)# enable service ssh-sesrver	SSH Server
Ruijie(Config)# enable service telnet-server	Telnet Server
Ruijie(Config)# enable service web-server	Http Server

no enable service

```
Ruijie# configure terminal //  
Ruijie(config)# enable service ssh-server // SSH Server
```

LINE

LINE

```
LINE  
' LINE  
' / LINE VTY  
' LINE
```

LINE

LINE

```
LINE LINE LINE  
LINE
```



configure terminal	
Line vty <i>line number</i>	Line
transport input {all ssh telnet none}	Line
no transport input	LINE
default transport input	LINE

Line

LINE

Line

configure terminal	
Line vty <i>line number</i>	Line
access-class <i>access-list-number</i> {in out}	Line

no access-class *access-list-number* {in |out}

CTRL

TFTP

Xmodem

- ' TFTP
- ' XMODEM

TFTP

CLI

TFTP Server

Location TFTP Server IP

Ruijie# copy tftp: //location/ filename flash: filename [vrf vrfname]	URL filename

CLI

TFTP Server

Ruijie# copy flash: filename tftp: //location/filename [vrf vrfname]	filename URL

r

tftp

copy tftp:"//location/filename" flash:filename [vrf vrfname]

ftp xmodem

1

2

r

show version

redundancy force-switchover

,

1 **rgos.bin**

2 **copy**

3

Upgrade Slave CM MAIN successful!!

Upgrade CM MAIN successful!!

1

2

Installing is in process

Do not restart your machine before finish !!!!!!

.....

3

Installing process finished
Restart machine operation is permitted now !!!!!!

4

System restarting, for reason 'Upgrade product !'.

5

5 6 7

System load main program from install package

6

A new card is found in slot [1].
System is doing version synchronization checking
Current software version in slot [1] is synchronous.
System needn't to do version synchronization for this
card

System is doing version synchronization checking
Card in slot [3] need to do version synchronization

Version synchronization began
Keep power on, don't draw out the card and don't restart your
machine before finished !!!!!!

Transmission is OK, now, card in slot [3] need restart ...
Software installation of card in slot [3] is in process
!!
!!
!!
Software installation of card in slot [3] has finished
successfully
The version synchronization of card in slot [3] get finished
successfully.

r

Ping

Echo

RGOS

Echo
Ping

Ping

Ping

Ping

Ruijie# ping [<i>ip</i>] [<i>address</i>] [length <i>length</i>] [ntimes <i>times</i>] [data <i>data</i>][source <i>source</i>] [timeout <i>seconds</i>]	Ping

Ping 5
100Byte IP 2
' !' ' !'
ping

```
Ruijie# ping 192.168.5.1
Sending 5, 100-byte ICMP Echoes to 192.168.5.1, timeout is 2
seconds:
< press Ctrl+C to break >
!!!!
Success rate is 100 percent (5/5), round-trip min/avg/max =
1/2/10 ms
```

Ping

Ping

Ping

Ping

```
Ruijie# ping 192.168.5.197 length 1500 ntimes 100 data ffff
source 192.168.4.190 timeout 3
Sending 100, 1000-byte ICMP Echoes to 192.168.5.197, timeout
is 3 seconds:
< press Ctrl+C to break >
!!!!!!!!!!!!!!!!!!!!!!!!!!!!!!!!!!!!!!!!!!!!!!!!!!!!!!!!!!!!!!!!!!!!
!!!!!!!!!!!!!!!!!!!!!!!!!!!!!!!!!!!!!!!!!!!!!!!!!!!!!!!!!!!!!!!!!!!!
Success rate is 100 percent (100/100), round-trip min/avg/max
= 2/2/3 ms
```

Traceroute

Traceroute
Traceroute

Tracing the route to 202.108.37.42

1	192.168.12.1	0 msec	0 msec	0 msec
2	192.168.9.2	0 msec	4 msec	4 msec
3	192.168.110.1	16 msec	12 msec	16 msec
4	* * *			
5	61.154.8.129	12 msec	28 msec	12 msec
6	61.154.8.17	8 msec	12 msec	16 msec
7	61.154.8.250	12 msec	12 msec	12 msec
8	218.85.157.222	12 msec	12 msec	12 msec
9	218.85.157.130	16 msec	16 msec	16 msec
10	218.85.157.77	16 msec	48 msec	16 msec
11	202.97.40.65	76 msec	24 msec	24 msec
12	202.97.37.65	32 msec	24 msec	24 msec
13	202.97.38.162	52 msec	52 msec	224 msec
14	202.96.12.38	84 msec	52 msec	52 msec
15	202.106.192.226	88 msec	52 msec	52 msec
16	202.106.192.174	52 msec	52 msec	88 msec
17	210.74.176.158	100 msec	52 msec	84 msec
18	202.108.37.42	48 msec	48 msec	52 msec

IP 202.108.37.42

1 17 4

- ' (L2 interface)
- ' (L3 interface) ()

(L2 interface)

- ' Switch Port
- ' L2 Aggregate Port

Switch Port

Switch Port
 Access Port Trunk Port Switch Port
 Access Port Trunk Port Switch Port

Access Port

Access Port VLAN, VLAN

VLAN

Acces3(cort)6TT1 1 Tf0-0.0006 Tc 0.014231.486'

Access Port	TAG	TAG	VLAN	TAG
	TAG			

Tagged

Access		TAG		
'	TAG	VID	VLAN ID	VLAN ID
	TAG			
'	TAG	VID	VLAN ID	0
				TAG
				VID 0
'	TAG	VID	VLAN ID	VLAN ID
				0

Trunk Port

Trunk port		VLAN		VLAN
VLAN				
Trunk Port		VLAN		Native vlan
VLAN		Trunk port	VLAN	
		VLAN		Trunk port
				VLAN

r				
	Trunk	native vlan	Trunk	native
vlan				

Trunk port	Untagged	VLAN	tagged	Trunk Port
	Native vlan	TAG	Native vlan	TAG

Untagged

Trunk port		IEEE802.1Q TAG,		Native
VLAN				

Tagged

Trunk port		TAG		
'	Trunk Port	TAG	VID	Trunk port
			TAG	Native vlan
'	Trunk Port	TAG	VID	Trunk port
				Native vlan

L3 Aggregate Port

L3 Aggregate port L2 Aggregate Port

AP

L3 Aggregate port
L3 Aggregate port

L3 Aggregate port
AP

L3 Aggregate port

Ruijie(config)# interface <i>ID</i>	interface interface range interface range macro

Gigabitethernet 2/1

```
Ruijie(config)# interface gigabitethernet 2/1
Ruijie(config-if)#
```

interface range

interface range

interface range

--	--

interface range

```
Ruijie# configure terminal
Ruijie(config)# interface range fastethernet 0/1 - 10
Ruijie(config-if-range)# no shutdown
Ruijie(config-if-range)#
```

, range

```
Ruijie# configure terminal
Ruijie(config)# interface range fastethernet 0/1-5, 1/7-8
Ruijie(config-if-range)# no shutdown
Ruijie(config-if-range)#
```

macro **interface range**
interface-range **define**

Ruijie(config)# define interface-range macro_name interface-range	macro_name 32
Ruijie(config)# interface range macro macro_name	interface range

no define interface-range macro_name

define interface-range

- **vlan** *vlan-ID - vlan-ID*, VLAN ID 1 4094
 - **fastethernet** *slot*{ *port*} - { *port*}
 - **gigabitethernet** *slot*{ *port*} - { *port*}
 - **Aggregate Port** *Aggregate port* - *Aggregate port* , 1 MAX
- interface range** switch port
Aggregate Port SVI

define interface-range

fastethernet0/1-4

```
Ruijie# configure terminal  
Ruijie(config)# define interface-range resource  
fastethernet 0/1-4  
Ruijie(config)# end
```

```
Ruijie# configure terminal  
Ruijie(config)# define interface-range ports1to2N5to7  
fastethernet 0/1-2, 1/5-7  
Ruijie(config)# end
```

ports1to2N5to7

```
Ruijie# configure terminal  
Ruijie(config)# interface range macro ports1to2N5to7  
Ruijie(config-if-range)#
```

ports1to2N5to7

```
Ruijie# configure terminal  
Ruijie(config)# no define interface-range ports1to2N5to7  
Ruijie# end
```

Aggregate Port SVI

Aggregate Port
Aggregate Port

AP

Ruijie(config-if)# medium-type { fiber copper }	

Gigabitethernet 1/1

```
Ruijie# config terminal  
Enter configuration commands, one per line. End with CNTL/Z.  
Ruijie(config)# interface gigabitethernet 1/1
```

```
Ruijie(config-if)# medium-type fiber
Ruijie(config-if)# end
```

```
(Description)
Gigabitethernet 1/1      A
" Port for User A"
```

Ruijie(config-if)# description string	32

Gigabitethernet 1/1

```
Ruijie# config terminal
Enter configuration commands, one per line. End with CNTL/Z.
Ruijie(config)# interface gigabitethernet 1/1
Ruijie(config-if)# description PortForUser A
Ruijie(config-if)# end
```

```
down      up      Up      Down
```

Ruijie(config-if)# shutdown	

Gigabitethernet 1/2

```
Ruijie# configure terminal
Ruijie(config)# interface gigabitethernet 1/2
Ruijie(config-if)# shutdown
Ruijie(config-if)# end
```

Switch Port,Routed Port



auto

```
Ruijie(config-if)# speed {10 |  
100 | 1000 | auto }      1000  
                          1000M
```

Ruijie(config-if)# mtu num

MTU Num <64-9216>

Gigabitethernet 1/1 MTU

Ruijie# **config terminal**

Enter configuration commands, one per line. End with CNTL/Z.

Ruijie(config)# **interface gigabitethernet 1/1**

Ruijie(config-if)# **mtu 64**

Ruijie(config-if)# **end**

/

S3760

10/100M

MTU

1490 Bytes

1500Bytes

```

Ruijie# configure terminal
Enter configuration commands, one per line. End with CNTL/Z.
Ruijie(config)# interface gigabitethernet 2/1
Ruijie(config-if)# switchport trunk native vlan 10
Ruijie(config-if)# end

```

" "

Ruijie(config-if)# switchport port-security	

Gigabitethernet 2/1

```

Ruijie# configure terminal
Enter configuration commands, one per line. End with CNTL/Z.
Ruijie(config)# interface gigabitethernet 2/1
Ruijie(config-if)# switchport port-security
Ruijie(config-if)# end

```

" "

Gigabitethernet 2/1 access port VLAN 100

```

Ruijie# configure terminal
Enter configuration commands, one per line. End with CNTL/Z.
Ruijie(config)# interface gigabitethernet 2/1
Ruijie(config-if)# switchport access vlan 100
Ruijie(config-if)# speed auto
Ruijie(config-if)# duplex auto
Ruijie(config-if)# flowcontrol auto
Ruijie(config-if)# switchport port-security
Ruijie(config-if)# end

```

Hybrid

Hybrid

configure terminal	
interface <interface>	,
switchport mode hybrid	hybrid

no switchport mode

Ruijie(config-if)# **end**

Routed port

	Routed Port	Routed Port	
		no switchport	Routed port
Routed port	Routed port	IP	
Ruijie(config-if)# no switchport		Shut Down	
Ruijie(config-if)# ip address <i>ip_address subnet_mask</i>		IP	

r

L2 Aggregate Port

switchport/ no

L3 Aggregate Port

IP

Ruijie# **configure terminal**

Enter configuration commands, one per line. End with CNTL/Z.

FlowControlOperStatus : Disabled
Priority : 1

SVI 5

Ruijie# **show interfaces vlan 5**
VLAN : V5
Description : SVI 5
AdminStatus : up
OperStatus : down
Primary Internet address : 192.168.65.230/24
Broadcast address : 192.168.65.255
PhysAddress : 00d0.f800.0001
LastChange : 0:0h:0m:5s

Aggregate Port 3

Ruijie# **show interfaces aggregateport 3**
Interface : AggreatePort 3
Description :
AdminStatus : up
OperStatus : down
Hardware : -
Mtu : 1500
LastChange : 0d:0h:0m:0s
AdminDuplex : Auto
OperDuplex : Unknown
AdminSpeed : Auto
OperSpeed : Unknown
FlowControlAdminStatus : Autonego
FlowControlOperStatus : Disabled
Priority : 0

GigabitEthernet 1/1

Ruijie# **show interfaces gigabitEthernet 1/1 switchport**
Interface Switchport Mode Access Native Protected
VLAN lists

gigabitethernet 1/1 Enabled Access 1 1
Enabled All

GigabitEthernet 2/1

Ruijie# **show interfaces gigabitEthernet 1/2 description**
Interface Status Administrative Description

gigabitethernet 2/1 down down Gi 2/1

```
Ruijie# show interfaces gigabitethernet 1/2 counters
Interface : gigabitethernet 1/2
5 minute input rate  9144 bits/sec, 9 packets/sec
5 minute output rate 1280 bits/sec, 1 packets/sec
InOctets             : 17310045
InUcastPkts         : 37488
InMulticastPkts     : 28139
InBroadcastPkts     : 32472
OutOctets            : 1282535
OutUcastPkts        : 17284
OutMulticastPkts    : 249
OutBroadcastPkts    : 336
Undersize packets   : 0
Oversize packets    : 0
collisions           : 0
Fragments           : 0
Jabbers             : 0
CRC alignment errors : 0
AlignmentErrors     : 0
FCSErrors           : 0
dropped packet events (due to lack of resources): 0
packets received of length (in octets):
64:46264, 65-127: 47427, 128-255: 3478,
256-511: 658, 512-1023: 18016, 1024-1518: 125
```

LinkTrap

Link	SNMP	LinkTrap
		LinkTrap,

--	--

```
Ruijie(config)# interface gigabitEthernet 1/1  
Ruijie(config-if)# no snmp trap link-status
```

Aggregate Port

Aggregate Port

Aggregate Port

Aggregate Port AP AP IEEE802.3ad

AP AP AP AP

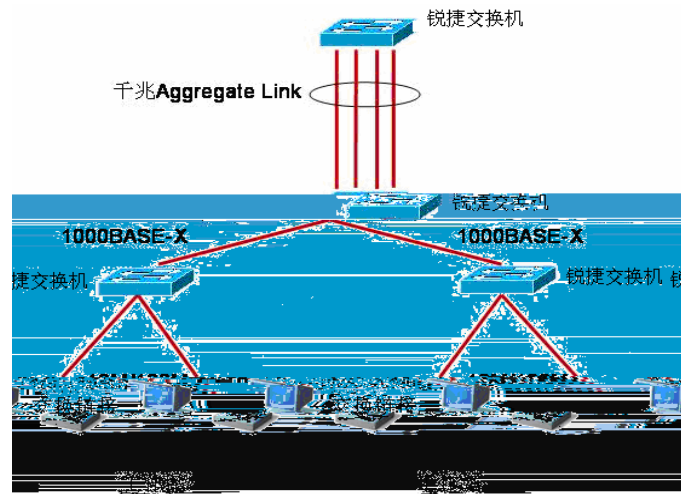

1 AP

S3760 AP 8
AP 31

AP MAC MAC MAC + MAC
 IP IP IP + IP
 AP **aggregateport load-balance**

MAC MAC MAC AP
 MAC M1 Trã 252 HCTã F@ 044% 11ã 13ã B02C8020

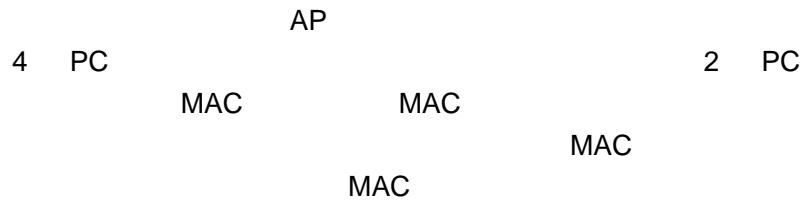

/

```

IP      IP      IP      IP      2
aggregateport load-balance
show aggregateport load-balance

```

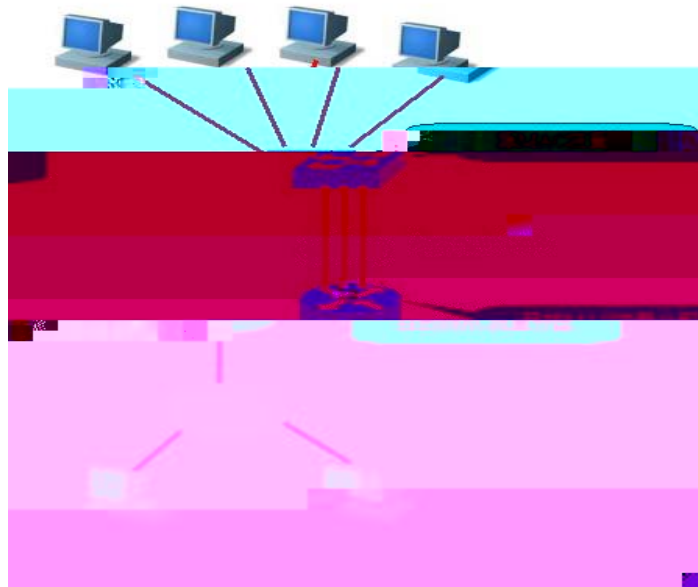

2 AP

Aggregate Port

Aggregate Port

AP

AP	
AP	



Aggregate Port

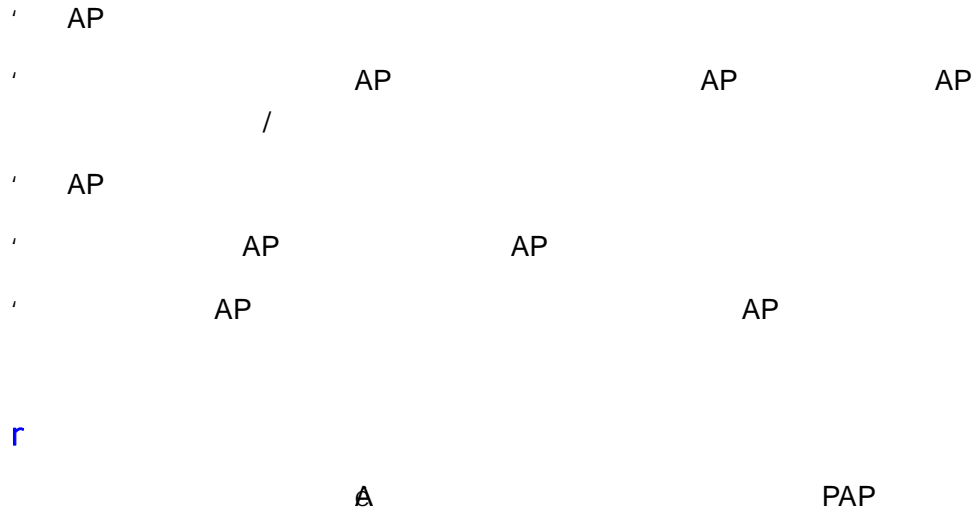

Aggregate Port

```

Aggregate Port          AP          AP
                        AP          AP 3          IP
192.168.1.1
Ruijie# configure terminal
Ruijie(config)# interface aggregateport 3
Ruijie(config-if)# no switchport
Ruijie(config-if)# ip address 192.168.1.1 255.255.255.0
Ruijie(config-if)# end

```

```

r
port-group          AP          AP
                    AP

```

```

AP          AP
fastEthernet 0/1-3          AP 2
Ruijie# configure terminal
Ruijie(config)# interface range fastEthernet 0/1-3
Ruijie(config-if)# no switchport
Ruijie(config-if)# port-group 2

```

Aggregate Port

AP

Ruijie(config)# aggregateport load-balance {src-dst-mac src-dst-ip}	<pre> AP src-dst-ip IP IP src-dst-mac MAC MAC </pre>

```

AP
no aggregateport load-balance

```

Aggregate Port

AP

Ruijie# show aggregateport [<i>port-number</i>]{ load-balance summary }	AP

```
Ruijie# show aggregateport load-balance
Load-balance : Source MAC address
Ruijie#show aggregateport 1 summary
AggregatePort MaxPorts SwitchPort Mode  Ports
-----
Ag1           8           Enabled  ACCESS
```

VLAN

IEEE802.1q VLAN

VLAN

Virtual Local Area Network

ISO

VLAN

VLAN

VLAN

VLAN

VLAN

N N

Y

VLAN

VLAN

1-4094)	VLAN VLAN 1	IEEE802.1Q VLAN	4094	VLAN(VLAN ID
---------	----------------	--------------------	------	--------------

r

VLAN ID	1	1 4094
VLAN Name	VLAN xxxx xxxx	VLAN ID
VLAN State	Active	Active Inactive

VLAN

VLAN

Ruijie(config)# vlan <i>vlan-id</i>	VLAN ID VLAN ID VLAN VLAN ID	VLAN
Ruijie(config)# name <i>vlan-name</i>	VLAN xxxx VLAN ID 0004	xxxx 0 VLAN VLAN 4

VLAN

no name

VLAN 888

Test888

```
Ruijie# configure terminal
Ruijie(config)# vlan 888
Ruijie(config-vlan)# name test888
Ruijie(config-vlan)# end
```

VLAN

VLAN VLAN 1

VLAN

Ruijie(config)# no vlan <i>vlan-id</i>	VLAN ID
---	---------

VLAN Access

VLAN

VLAN

VLAN

--	--

Ruijie(config-if)# **switchport
mode access**

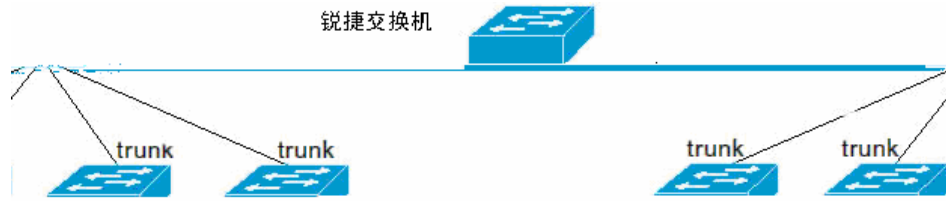

2

Aggregate Port Aggregate Port Trunk

Aggregate Port Aggregate Port

ACCESS TRUNK **switchport**

mode

Ruijie(config-if)# switchport mode access	Access
Ruijie(config-if)# switchport mode trunk	Trunk

Trunk Native VLAN Native VLAN

UNTAG VLAN VLAN

ID IEEE 802.1Q PVID Native VLAN VLAN ID Trunk

Native VLAN UNTAG Trunk

Native VLAN VLAN 1

Trunk Trunk Native VLAN

Trunk

Trunk

Trunk

Ruijie(config-if)# switchport mode trunk	Trunk

Ruijie(config-if)# switchport trunk native vlan <i>vlan-id</i>	Native VLAN
---	-------------

switchport mode Trunk Trunk **no**

Trunk VLAN

Trunk VLAN 1 4094
Trunk VLAN VLAN
Trunk
Trunk VLAN

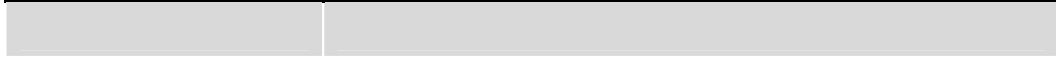

Ruijie(config-if)# switchport trunk native vlan <i>vlan-id</i>	Native VLAN

Trunk Native VLAN VLAN 1 **no switchport trunk native vlan**

Native VLAN VLAN ID Trunk TAG

Native VLAN VLAN VLAN Native VLAN Native VLAN VLAN

VLAN

VLAN VLAN VLAN VID VLAN

show vlan [id <i>vlan-id</i>]	VLAN

VLAN

Ruijie#**show vlan**

VLAN	Name	Status	Ports
1	VLAN0001	STATIC	Gi0/1, Gi0/5, Gi0/6, Gi0/7 Gi0/8, Gi0/9, Gi0/10, Gi0/11 Gi0/12, Gi0/13, Gi0/14, Gi0/15 Gi0/16, Gi0/17, Gi0/18, Gi0/19 Gi0/20, Gi0/21, Gi0/22, Gi0/23 Gi0/24
10	VLAN0010	STATIC	Gi0/2, Gi0/3
20	VLAN0020	STATIC	Gi0/2, Gi0/3, Gi0/4
30	VLAN0030	STATIC	Gi0/3, Gi0/4

Ruijie#**show vlan id 20**

VLAN	Name	Status	Ports
20	VLAN0020	STATIC	Gi0/2, Gi0/3, Gi0/4

Super VLAN

Super VLAN

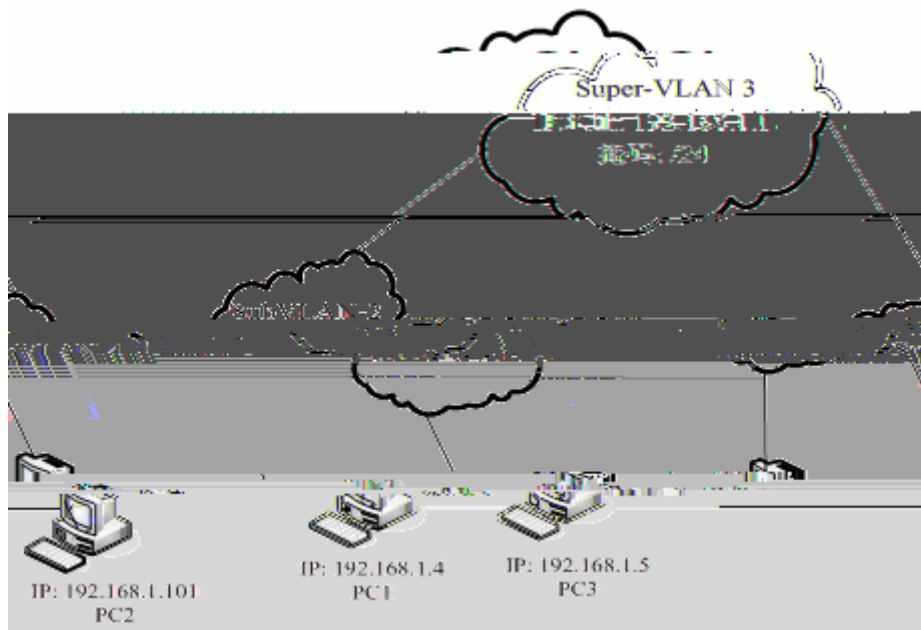
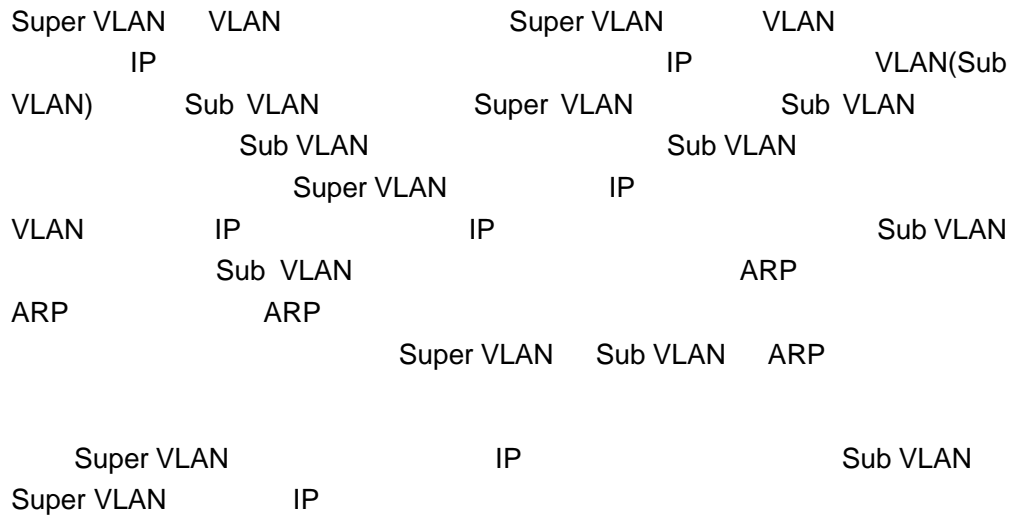

1

VLAN

Sub-VLAN

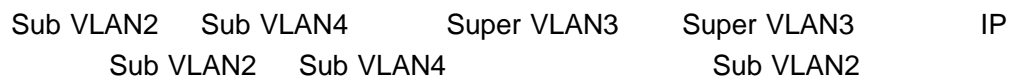

r

SubVLAN

Ruijie# configure	
Ruijie(config)# vlan <i>vlan-id</i>	VLAN
Ruijie(config-vlan)# supervlan	vlan SuperVLAN
Ruijie(config-vlan)# subvlan <i>vlan-id-list</i>	sub vlan supervlan
Ruijie(config-vlan)# exit	

no subvlan [*vlan-id-list*] SuperVLAN SubVLAN

r

no vlan SubVLAN VLAN

Sub VLAN

SubVLAN SubVLAN IP
SubVLAN. SuperVLAN SubVLAN

Ruijie# configure	
Ruijie(config)# vlan <i>vlan-id</i>	vlan
Ruijie(config-vlan)# subvlan-address-range <i>start-ip end-ip</i>	VLAN start-ip SubVLAN IP end-ip SubVLAN IP
Ruijie(config-vlan)# end	
Ruijie# show run	

r

no subvlan-address-range

Super VLAN

Sub VLAN , SuperVLAN

SuperVLAN SVI

Ruijie# configure	
Ruijie(config)# interface vlan <i>vlan-id</i>	SVI
Ruijie(config-vlan)# ip address <i>ip address</i>	

Super VLAN

```
'      Super-VLAN  VLAN 2      Sub-VLAN  VLAN 3
      VLAN
'  Sub-VLAN 3      192.168.196.51~192.168.196.100  Sub-VLAN 4
      192.168.196.101~192.168.196.150
'      Super-VLAN      IP      192.168.196.1
      255.255.255.0
'      VLAN  ARP
```

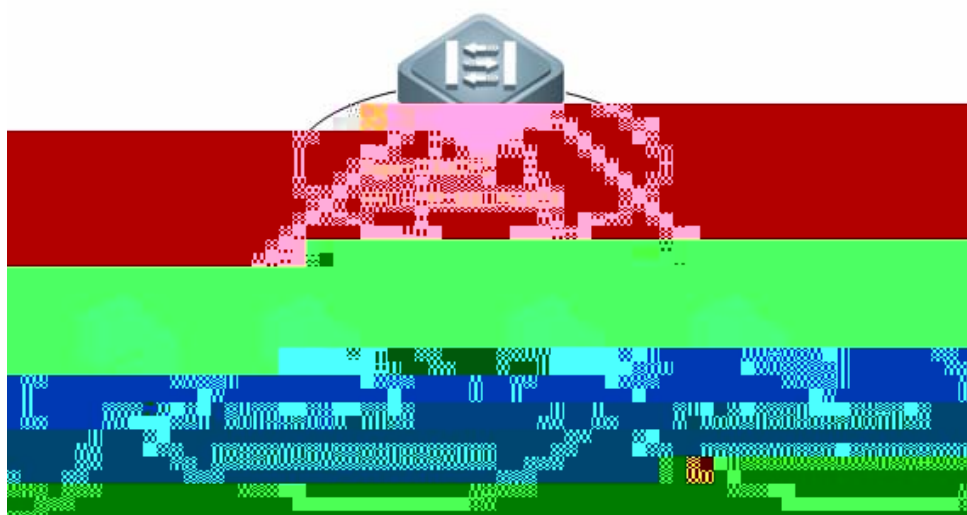

```
#
Ruijie# configure terminal
#   VLAN 2      VLAN
Ruijie(config)# vlan 2
#   VLAN 2  Super VLAN
Ruijie(config-vlan)# supervlan
#
```

Super VLAN

```
Ruijie(config-if)# exit
Ruijie(config)# vlan 2
Ruijie(config-vlan)# proxy-arp

#

Ruijie(config-vlan)# end
Ruijie# show supervlan
supervlan id  supervlan arp-proxy  subvlan id  subvlan
arp-proxy  subvlan ip range
-----
2          ON          3      ON  192.168.196.51 -
192.168.196.100
          4      ON  192.168.196.101 -
192.168.196.150
```

Protocol VLAN

Protocol VLAN

VLAN VLAN

1) VLAN ID UNTAG Priority
VLAN TAG VLAN ID PVID

2) VLAN ID UNTAG Priority
VLAN TAG VLAN ID
VLAN ID
VLAN

3) VLAN ID
TAG VLAN TAG VLAN ID

Protocol VLAN VLAN

VLAN ID VLAN

Protocol VLAN Trunk Hybrid Access

VLAN IP VLAN

IP VLAN IP VLAN

1) Trunk Hybrid
VLAN ID , IP IP
VLAN

2) VLAN ID ,

VLAN

IP VLAN IP VLAN
VLAN

IP VLAN

Protocol VLAN Trunk Hybrid Access AP
Trunk Hybrid Protocol VLAN
Trunk Hybrid VLAN Protocol VLAN

VLAN

Protocol VLAN

Protocol VLAN

Protocol VLAN

profile

configure terminal	
protocol-vlan profile <i>id</i> frame-type [<i>type</i>] ether-type [<i>type</i>]	profile
no protocol-vlan profile <i>id</i>	profile
no protocol-vlan profile	profile
end	VLAN
show protocol-vlan profile	profile
show protocol-vlan profile <i>id</i>	profile

```
Ruijie# configure terminal
Ruijie(config)# protocol-vlan profile 1 frame-type ETHERII
ether-type EHTER_AARP
Ruijie(config)# protocol-vlan profile 2 frame-type SNAP
ether-type 0x809b
Ruijie(config-vlan)# end
Ruijie# show protocol-vlan profile
profile          frame-type ether-type          Interfaces|vid
-----
1                ETHERII    EHTER_AARP          NULL|NULL
2                SNAP      ETHER_APPLETALK    NULL|NULL
```

/

```
1 Profile
2 Profile Profile Profile
```

```

3          Profile          S3760   11  profile
4  S3760          0x0806  ARP
    
```

profile

:

configure terminal	
interface [ID]	
protocol-vlan profile id vlan vid	profile
no protocol-vlan profile	profile
no protocol-vlan profile id	profile
end	

```

profile 1  profile 2          3  GE  1,VLAN  VLAN 101
102:
    
```

```

Ruijie# configure terminal
Ruijie(config)# interface gi 3/1
Ruijie(config-if)# protocol-vlan profile 1 vlan 101
Ruijie(config-if)# protocol-vlan profile 2 vlan 102
Ruijie(config-if)# end
Ruijie# show protocol-vlan profile
profile          frame-type  ether-type      Interfaces|vid
-----
1                ETHERII    EHTER_AARP     gi3/1|101
2                SNAP      ETHER_APPLETALK gi3/1|102
    
```

```

/
1                profile
2                profile          vid
3                VID              S3760          4094
                VLAN
    
```

Protocol VLAN

Protocol VLAN

show protocol-vlan	Protocol VLAN

Ruijie# **show protocol-vlan**

Private VLAN

Private VLAN

4096 VLAN VLAN
Private VLAN IP VLAN
VLAN(Private VLAN) VLAN VLAN(Primary VLAN) VLAN(Secondary
VLAN) VLAN
VLAN ID VLAN VLAN VLAN
VLAN(Isolated VLAN) VLAN
VLAN(Community VLAN) VLAN VLAN
Promiscuous Port VLAN
VLAN (Isolated Port) VLAN
VLAN (Community port) VLAN VLAN
VLAN VLAN SVI VLAN SVI
VLAN SPAN
S3760 MAC
S3760 TRUNK PORT
trunk port
trunk port vlan

```

fa0/2 fa0/5 fa0/6 trunk port pvlan
fa0/2
trunk port trunk port
S3760 trunk port vlan MAC
    
```

Private VLAN

Private VLAN

Private VLAN

VLAN VLAN

configure terminal	
vlan vid	VLAN
private-vlan{community isolated primary}	VLAN
no private-vlan{community isolated primary}	VLAN
end	VLAN
show vlan private-vlan [type]	VLAN

/

```

802.1Q Vlan VLAN VLAN 1
VLAN Trunk Uplink 802.1Q VLAN VLAN
VLAN Private VLAN ACTIVE
1) Priamry VLAN
2) Secondary VLAN
3) Secondary VLAN Primary VLAN
    
```

802.1Q VLAN Private VLAN

```

Ruijie# configure terminal
Ruijie(config)# vlan 303
    
```

```

Ruijie(config-vlan)# private-vlan community
Ruijie(config-vlan)# end
Ruijie# show vlan private-vlan community
VLAN Type Status Routed Interface Associated VLANs
--- ---- -
303 comm inactive Disabled no association
Ruijie# configure terminal
Ruijie(config)# vlan 404
Ruijie(config-vlan)# private-vlan isolated
Ruijie(config-vlan)# end
Ruijie# show vlan private-vlan
VLAN Type Status Routed Interface Associated VLANs
--- ---- -
303 comm inactive Disabled no association
404 isol inactive Disabled no association

```

Secondary VLAN Primary VLAN

Secondary VLAN Primary VLAN

configure terminal	
vlan <i>p_vid</i>	Primary VLAN
private-vlan association { <i>svlist</i> add <i>svlist</i> remove <i>svlist</i> }	Secondary VLAN
no private-vlan association	Secondary VLAN
end	VLAN
show vlan private-vlan [type]	VLAN

```

Ruijie# configure terminal
Ruijie(config)# vlan 202
Ruijie(config-vlan)# private-vlan association 303-307,309,440
Ruijie(config-vlan)# end
Ruijie# show vlan private-vlan
VLAN Type Status Routed Interface Associated VLANs
--- ---- -
202 prim inactive Disabled 303-307,309,440
303 comm inactive Disabled 202
304 comm inactive Disabled 202
305 comm inactive Disabled 202

```

```

306 comm inactive Disabled 202
307 comm inactive Disabled 202
309 comm inactive Disabled 202
440 comm inactive Disabled 202
    
```

/

Primary VLAN VLAN

Secondary VLAN Primary VLAN

configure terminal	
interface vlan <i>p_vid</i>	Primary VLAN
private-vlan mapping { <i>svlist</i> add <i>svlist</i> remove <i>svlist</i> }	Secondary VLAN Primary VLAN SVI
end	

Secondary VLAN

```

Ruijie# configure terminal
Ruijie(config)# interface vlan 202
Ruijie(config-if)# private-vlan mapping add 303-307,309,440
Ruijie(config-if)# end
Ruijie#
    
```

/

Primary VLAN Secondary VLAN

VLAN

VLAN (Host Port)

--	--

configure terminal	
interface <interface>	<i>fastethernet, gigabitethernet, tengigabitethernet</i>
switchport mode private-vlan host	
no switchport mode	VLAN
end	SVI
switchport private-vlan host-association p_vid s_vid	VLAN
no switchport private-vlan	

switchport private-vlan mapping <i>p_vid{svlist add svlist remove svlist}</i>	VLAN VLAN VLAN	secondary
no switchport private-vlan mapping	VLAN.	secondary

```
Ruijie# configure terminal
Ruijie(config)# interface gigabitEthernet 0/2
Ruijie(config-if)# switchport mode private-vlan promiscuous
Ruijie(config-if)# switchport private-vlan mapping 202 add 203
Ruijie(config-if)# end
Ruijie#
```

/

Primary VLAN Secondary VLAN

Private VLAN

private VLAN

Private VLAN

show vlan private-vlan [type]	private VLAN
--------------------------------------	--------------

```
Ruijie# show vlan private-vlan
VLAN Type  Status   Routed  Interface  Associated VLANs
-----
202 prim   active  Enabled  Gi0/1     303-307,309,440
303 comm  active  Disabled Gi0/2     202
304 comm  active  Disabled Gi0/3     202
305 comm  active  Disabled Gi0/4     202
306 comm  active  Disabled      202
307 comm  active  Disabled      202
309 comm  active  Disabled      202
440 comm  active  Enabled   Gi0/5     202
```

Private VLAN

Private VLAN

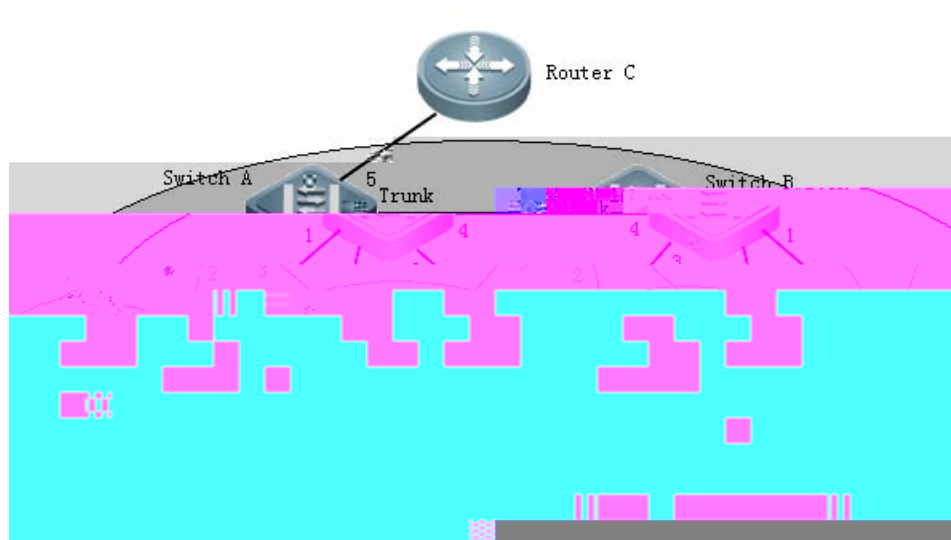

1

```
# VLAN 99 Primary VLAN VLAN 100 Community VLAN  
VLAN 101 Isolated VLAN VLAN
```

```
Ruijie#configure terminal  
Enter configuration commands, one per line. End with CNTL/Z.  
Ruijie(config)#vlan 99  
Ruijie(config-vlan)#private-vlan primary  
Ruijie(config-vlan)#exit  
Ruijie(config)#vlan 100  
Ruijie(config-vlan)#private-vlan community  
Ruijie(config-vlan)#exit  
Ruijie(config)#vlan 101  
Ruijie(config-vlan)#private-vlan isolated
```

```

Ruijie(config-vlan)#exit
Ruijie(config)#vlan 99
Ruijie(config-vlan)#private-vlan association 100,101
Ruijie(config-vlan)#exit

          0 1 0 2   Community VLAN 100   0/3   Isolated VLAN
101      0/4   Promiscuous Port

Ruijie(config)#interface gigabitEthernet 0/1
Ruijie(config-if)#switchport mode private-vlan host
Ruijie(config-if)#switchport private-vlan host-association 99
100
Ruijie(config-if)#exit
Ruijie(config)#interface gigabitEthernet 0/2
Ruijie(config-if)#switchport mode private-vlan host
Ruijie(config-if)#switchport private-vlan host-association 99
100
Ruijie(config-if)#exit
Ruijie(config)#interface gigabitEthernet 0/3
Ruijie(config-if)#switchport mode private-vlan host
Ruijie(config-if)#switchport private-vlan host-association 99
101
Ruijie(config-if)#exit
Ruijie(config)#interface gigabitEthernet 0/4
Ruijie(config-if)#switchport mode trunk
Ruijie(config-if)#exit
Ruijie(config)#interface gigabitEthernet 0/5
Ruijie(config-if)#switchport mode private-vlan promiscuous
Ruijie(config-if)#switchport private-vlan mapping 99 add
100-101
Ruijie(config-if)#show vlan private-vlan
VLAN      Type                Status      Routed      Ports
Associated VLANs
-----
99        primary            active      Disabled    Gi0/4,     Gi0/5
100-101
100      community        active      Disabled    Gi0/1, Gi0/2, Gi0/4    99
101      isolated         active      Disabled    Gi0/3, Gi0/4    99

```

Private VLAN

	Private VLAN		Private VLAN	SVI
Private VLAN	VLAN	Primary VLAN	Secondary VLAN	
	SVI		Primary VLAN	

Private VLAN

```
100
Ruijie(config-if)#exit
Ruijie(config)#interface gigabitEthernet 0/2
Ruijie(config-if)#switchport mode private-vlan host
Ruijie(config-if)#switchport private-vlan host-association 99
100
Ruijie(config-if)#exit
Ruijie(config)#interface gigabitEthernet 0/3
Ruijie(config-if)#switchport mode private-vlan host
Ruijie(config-if)#switchport private-vlan host-association 99
101
Ruijie(config-if)#exit
Ruijie(config)#interface gigabitEthernet 0/4
Ruijie(config-if)#switchport mode private-vlan promiscuous
Ruijie(config-if)#switchport private-vlan mapping 99 add
100-101
Ruijie(config-if)#exit
```

```
# Primary VLAN          SVI (192.168.1.1)          Secondary VLAN
Primary VLAN
```

```
Ruijie(config)#interface vlan 99
Ruijie(config-if)#ip address 192.168.1.1 255.255.255.0
Ruijie(config-if)#private-vlan mapping 100-101
Ruijie(config-if)#show vlan private-vlan
```

VLAN	Type	Status	Routed	Ports
Associated VLANs				
99	primary	active	Enabled	Gi0/4
100-101				
100	community	active	Enabled	Gi0/1, Gi0/2 99
101	isolated	active	Enabled	Gi0/3 99

MAC

MAC
MAC
Private VLAN
,
,
,
,
,
,
,
,
MAC
IP MAC
,

MAC

MAC

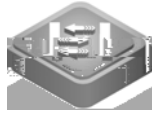

802.1X

ACL

:

	IPv4	IPv6
	IPV4+MAC	IPV6
	IPV4+MAC	IPV6
	IPV4+MAC	MAC IPV6

IP MAC

/

IP

IP

MAC

IEEE Std 802.3™ Carrier sense multiple access with collision detection (CSMA/CD) access method and physical layer specifications

IEEE Std 802.1Q™ Virtual Bridged Local Area Networks

	300
MAC	
	compatible

,

,



MAC

Ruijie#show mac-address-table dynamic interface <i>interface-id [vlan vlan-id]</i>	Aggregate Port
	interface-id Aggregate Port vlan-id VLAN
Ruijie#show mac-address-table dynamic vlan <i>vlan-id</i>	VLAN
	vlan-id VLAN
Ruijie# show mac-address-table count	

```

MAC
GigabitEthernet 0/1  VLAN
Ruijie#show mac-address-table dynamic interface gigabitEthernet
0/1 vlan 1
Vlan      MAC Address      Type      Interface
-----
1         0000.5e00.010c   DYNAMIC  GigabitEthernet 0/1
1         00d0.f822.33aa   DYNAMIC  GigabitEthernet 0/1
1         00d0.f822.a219   DYNAMIC  GigabitEthernet 0/1
1         00d0.f8a6.5af7   DYNAMIC  GigabitEthernet 0/1

Ruijie# show mac-address-table count
Dynamic Address Count : 30
Static Address Count  : 0
Filtering Address Count: 0
Total Mac Addresses   : 30
Total Mac Address Space Available: 8159

```



```
Ruijie(config)# mac-address-table agint-time  
[0 |10-1000000]
```

```
Ruijie(config)# mac-address-table static      mac-address      MAC  
mac-address vlan vlan-id interface interface-id
```

Ruijie(config)# mac-address-table filtering	mac-address	MAC
<i>mac-address</i> vlan <i>vlan-id</i>	vlan-id	VLAN
	vlan-id	VLAN
	mac- address	
Ruijie(config)# no mac-address-table		

MAC

MAC

MAC

MAC



MAC

```
Ruijie(config-if)#snmp trap mac-notification added  
Ruijie(config-if)#snmp trap mac-notification removed
```

MAC



MAC

Added 1 00d0.f80d.1083 Gi0/1

IP MAC

IP MAC

	IP	MAC
Ruijie(config)# address-bind <i>ip-address</i> <i>mac-address</i>	ip-address	mac-address
Ruijie(config)# address-bind install	IP	MAC

no address-bind *ip-address mac-address* IP

MAC

no address-bind install

IP MAC

Ruijie#**configure terminal**

Enter configuration commands, one per line. End with CNTL/Z.

Ruijie(config)#**address-bind** 192.168.5.1 00d0.f800.0001

Ruijie(config)#**address-bind install**

Ruijie(config)# address-bind ipv6-mode { compatible loose strict }	compatible loose strict
Ruijie(config)# no address-bind ipv6-mode	

Ruijie#**configure terminal**

Enter configuration commands, one per line. End with CNTL/Z.

Ruijie(config)#**address-bind ipv6-mode strict**

GigabitEthernet0/1
GigabitEthernet 0/2

WEB
WEB

VLAN 1

WEB

WEB
GigabitEthernet 0/3
GigabitEthernet 0/10

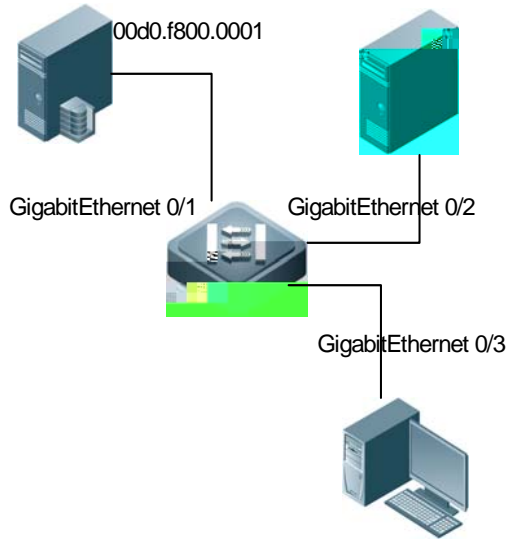

```
Ruijie(config)#mac-address-table static
```

DHCP Snooping

DHCP Snooping

DHCP

DHCP IP DHCP

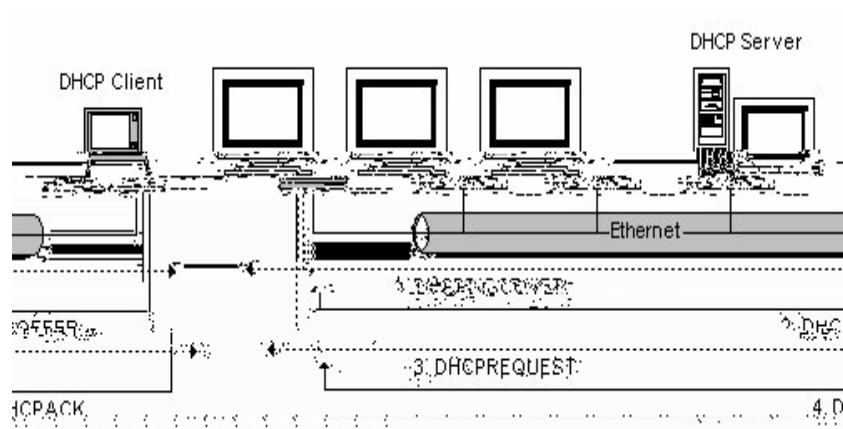

1

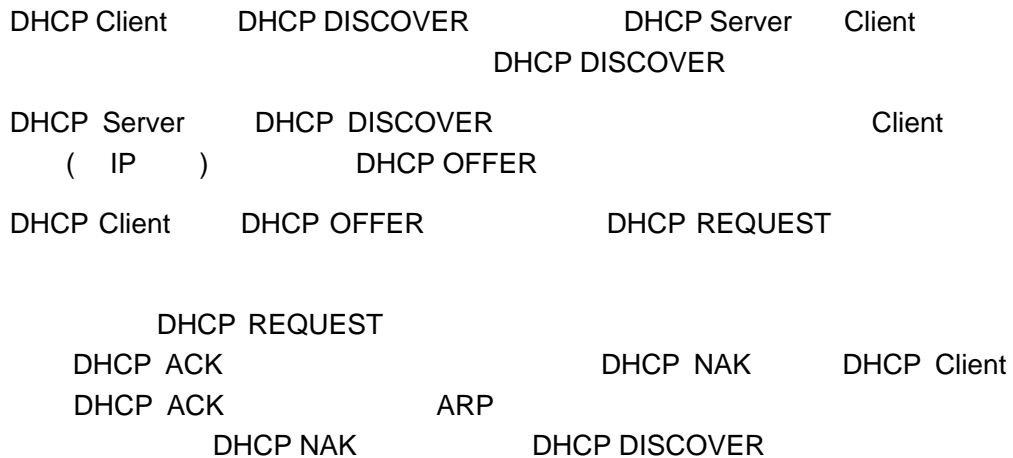

DHCP Snooping

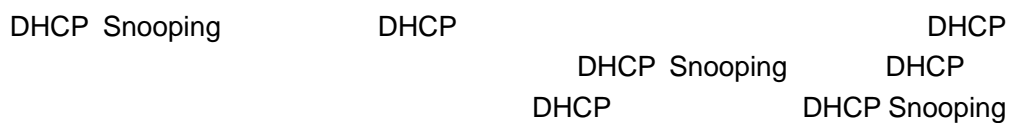

DHCP Snooping TRUST DHCP IP
 TRUST UNTRUST DHCP TRUST
 TRUST DHCP UNTRUST TRUST
 UNTRUST UNTRUST DHCP
 DHCP
 DHCP Snooping DHCP Snooping
 IP MAC VID PORT
 DHCP Snooping
 DHCP Snooping DHCP
 DHCP Snooping
 DHCP
 1) UNTRUST DHCP DHCPACK DHCPNAK
 DHCPOFFER
 2) mac MAC DHCP DHCP
 Client
 3) DHCP Snooping DHCPRELEASE

DHCP Snooping information option

IP
 IP DHCP DHCP
 option82 DHCP snooping option82
 IP DHCP snooping option82 DHCP

Agent Circuit ID

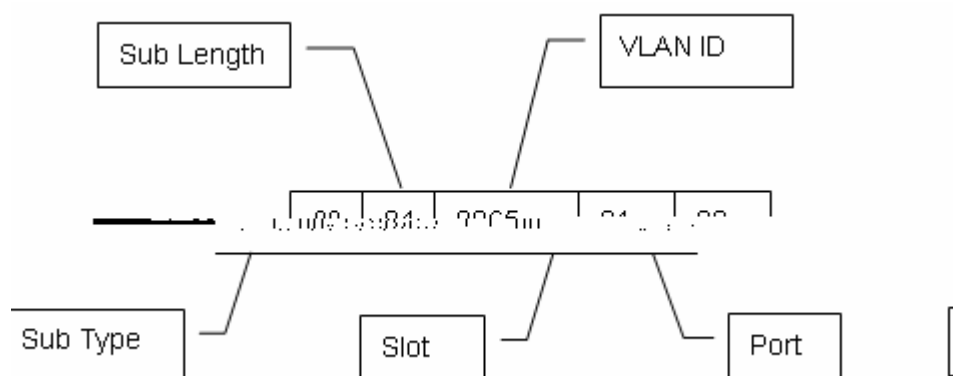

Agent Remote ID

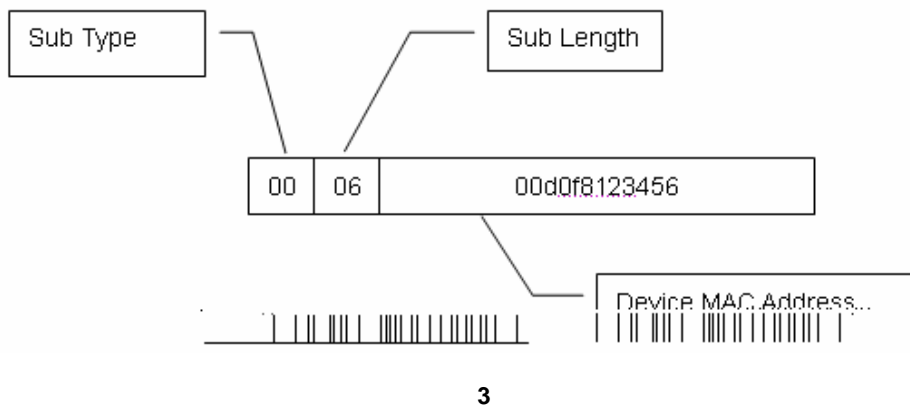

DHCP Snooping

DHCP snooping (IP MAC VLAN PORT DHCP

DHCP Snooping

- 1) DHCP Snooping DHCP Relay Option 82
 DHCP Snooping DHCP Relay Option82
- 2) TRUST

DHCP Snooping

DHCP Snooping

Snooping	DHCP Snooping	DHCP
Ruijie# configure terminal		
Ruijie(config)# [no] ip dhcp snooping		DHCP snooping

DHCP Snooping

```
Ruijie# configure terminal  
Ruijie(config)# ip dhcp snooping  
Ruijie(config)# end
```

r

DHCP Snooping Private VLAN

```
Ruijie(config)# end
```

DHCP Snooping Bootp

DHCP Snooping DHCP Snooping Bootp Bootp

DHCP Snooping DHCP Snooping Bootp Bootp

Ruijie# configure terminal	
Ruijie(config)# [no] ip dhcp snooping bootp-bind	DHCP snooping Bootp

DHCP Snooping Bootp

```
Ruijie# configure terminal  
Ruijie(config)# ip dhcp snooping bootp-bind  
Ruijie(config)# end
```

MAC

MAC DHCP Snooping

UNTRUST DHCP

MAC DHCP CLIENT MAC

Ruijie# configure terminal	
Ruijie(config)# [no] ip dhcp snooping verify mac-address	MAC

MAC

```
Ruijie# configure terminal  
Ruijie(config)# ip dhcp snooping verify mac-address  
Ruijie(config)# end
```

DHCP snooping information option

```
end
```

Ruijie# configure terminal	

DHCP Snooping

Flash

Flash

DHCP Snooping

Ruijie# configure terminal	
Ruijie(config)# ip dhcp snooping database write-to-flash	DHCP snooping flash

DHCP Snooping

Flash

```
Ruijie# configure terminal
Ruijie(config)# ip dhcp snooping database write-to-flash
Ruijie(config)# end
```

suppression

suppression

DHCP

Ruijie# configure terminal	
Ruijie(config)# interface interface-id	
Ruijie(config-if)# [no] ip dhcp snooping suppression	suppression

fastethernet 0/2 suppression

```
Ruijie# configure terminal
Ruijie(config)# interface fastethernet 0/2
Ruijie(config-if)# end
```

Ruijie(config-if)# [no] ip dhcp snooping trust	TRUST
--	-------

fastethernet 0/1 TRUST

```
Ruijie# configure terminal
Ruijie(config)# interface fastethernet 0/1
Ruijie(config-if)# ip dhcp snooping trust
Ruijie(config-if)# end
```

DHCP

DHCP
DHCP

Ruijie# configure terminal	
Ruijie(config)# interface fastethernet 0/1	
Ruijie(config-if)# [no] ip dhcp snooping limitrate rate-value	DHCP

fastethernet 0/1 DHCP 100pps

```
Ruijie# configure terminal
Ruijie(config)# interface fastethernet 0/1
Ruijie(config-if)# ip dhcp snooping limit rate 100
Ruijie(config-if)# end
Ruijie# show ip dhcp snooping
Switch DHCP snooping status ENABLE
Verification of hwaddr field status DISABLE
DHCP snooping database write-delay time: 0 seconds
DHCP snooping option 82 status: ENABLE
DHCP snooping Support Bootp bind status: ENABLE
Interface Trusted Rate limit (pps)
-----
FastEthernet0/1 NO 100
```

Ruijie#

Switch B

DHCP Snooping

```
Ruijie#configure terminal
Enter configuration commands, one per line. End with CNTL/Z.
Ruijie(config)#ip dhcp snooping

Ruijie(config)#interface gigabitEthernet 0/1
Ruijie(config-if-GigabitEthernet 0/1)#ip dhcp snooping trust
```

Switch B
DHCP Snooping

DHCP Snooping

```
Ruijie#show running-config
!
ip dhcp snooping
!
interface GigabitEthernet 0/1
ip dhcp snooping trust
```

Switch B DHCP Snooping

```
Ruijie#show ip dhcp snooping
Switch DHCP snooping status : ENABLE
DHCP snooping Verification of hwaddr status : DISABLE
DHCP snooping database write-delay time : 0 seconds
DHCP snooping option 82 status : DISABLE
DHCP snooping Support bootp bind status : DISABLE
Interface Trusted Rate limit (pps)
```

```
-----
GigabitEthernet 0/1 YES unlimited
DHCP Snooping MAC
```

IP VLAN

```
Ruijie#show ip dhcp snooping binding
Total number of bindings: 1
MacAddress IpAddress Lease(sec) Type VLAN
Interface
-----
0013.2049.9014 172.16.1.2 86207 dhcp-snooping 1
GigabitEthernet 0/11
```

IGMP Snooping

IGMP Snooping

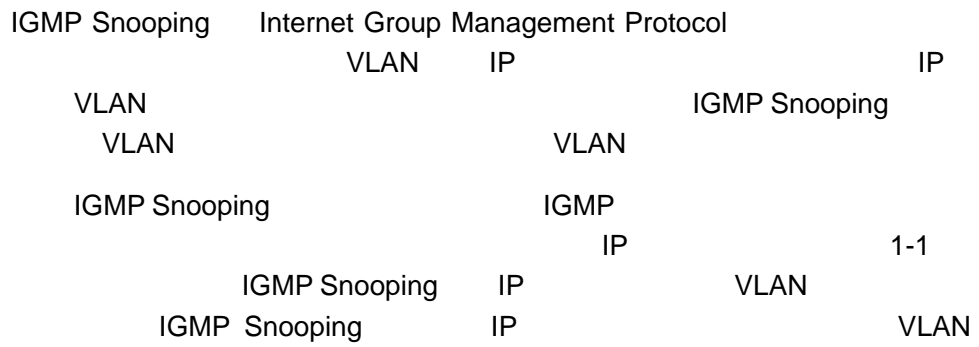

没有启动 IGMP Snooping 下的组播传输过程

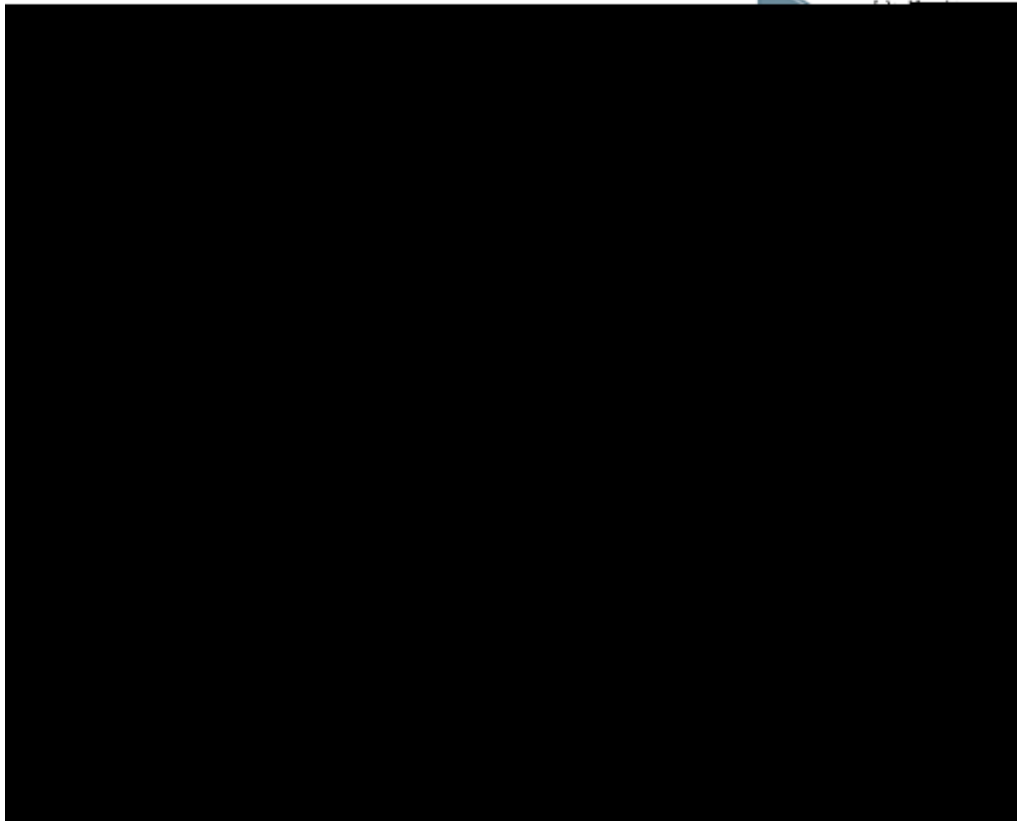

1-1 VLAN IGMP Snooping

IGMP Snooping

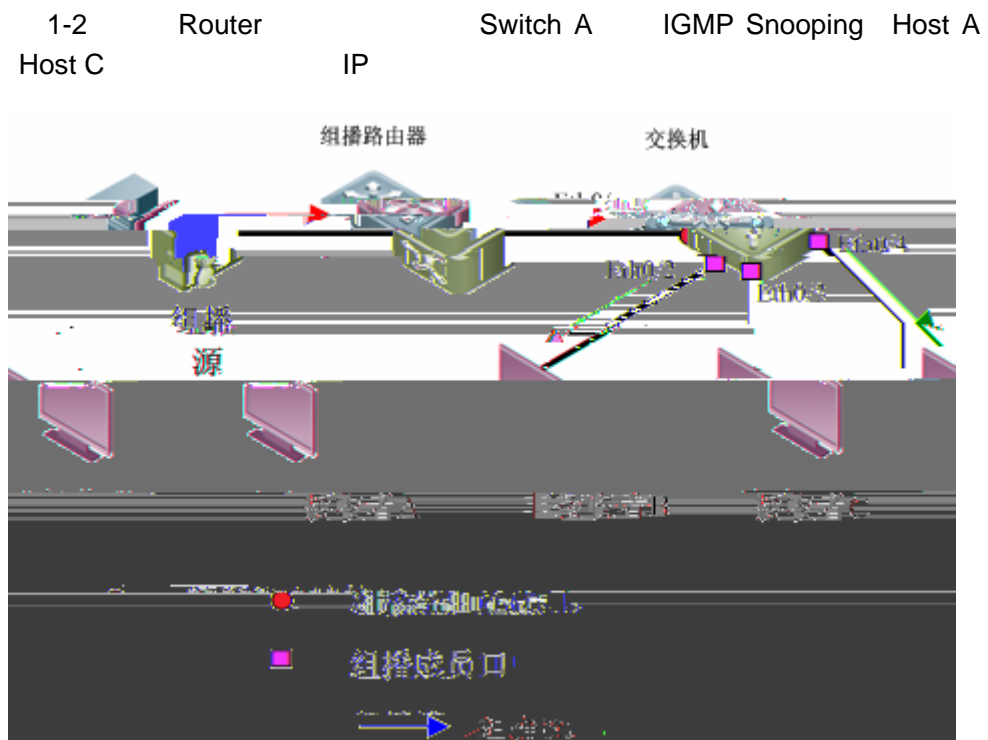

1-2 IGMP Snooping

Multicast Router Port

			Snooping
--	--	--	----------

IGMP Snooping

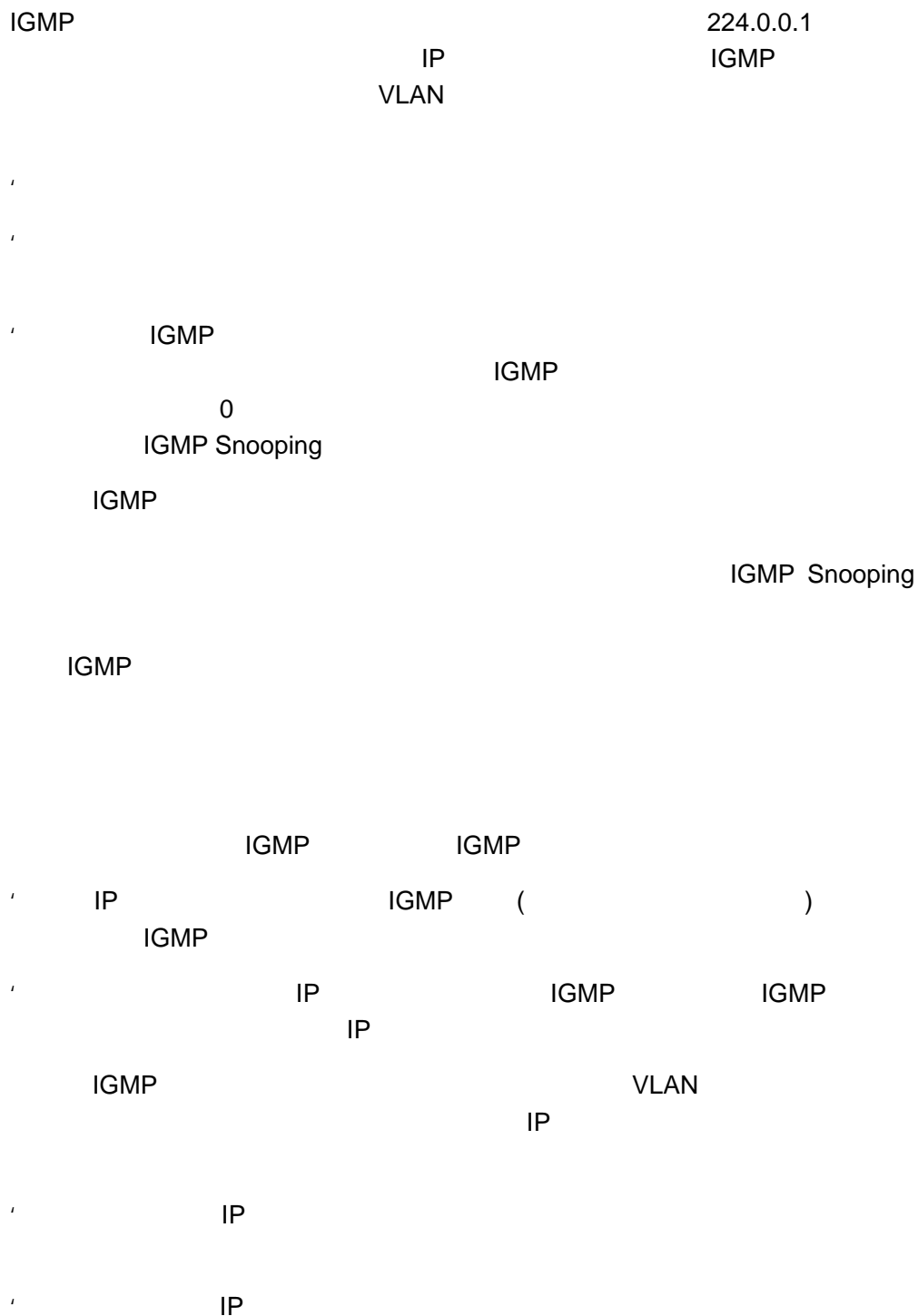

```

'
IP
IP
IP
IP
IGMP
IGMP
IGMP

```

IGMP Profiles

```

IGMP Profiles
" " permit deny " SVGL
" " IGMP Filtering "

```

IGMP Snooping

```

DISABLE IGMP Snooping
VLAN " " IGMP VLAN
IVGL (Independent VLAN Group Learning) VLAN
VLAN VLAN
VLAN VLAN

```

IGMP Snooping

IGMP Snooping

IGMP Snooping		
IGMP Snooping	IGMP Snooping	
	IGMP	
IGMP Snooping		

	IGMP	
IP	IP	

IGMP Snooping

IGMP Snooping
IVGL

IGMP Snooping

r	private vlan	IGMP snooping
---	--------------	---------------

IVGL

IGMP Snooping IVGL

Ruijie(config)# ip igmp snooping ivgl	IGMP Snooping IVGL IGMP Snooping
Ruijie(config)# show ip igmp snooping	
Ruijie(config)# no ip igmp snooping	IGMP Snooping

IGMP Snooping IVGL

```
Ruijie# configure terminal
Ruijie(config)# ip igmp snooping ivgl
Ruijie(config)# show ip igmp snooping
IGMP Snooping running mode: IVGL
SVGL vlan: 1
SVGL profile number: 0
Source port check: Disable
Source ip check: Disable
IGMP Fast-Leave: Disable
IGMP Report suppress: Disable
```

IGMP Snooping

IGMP Snooping

Ruijie(config)# no ip igmp snooping	IGMP Snooping IGMP Snooping

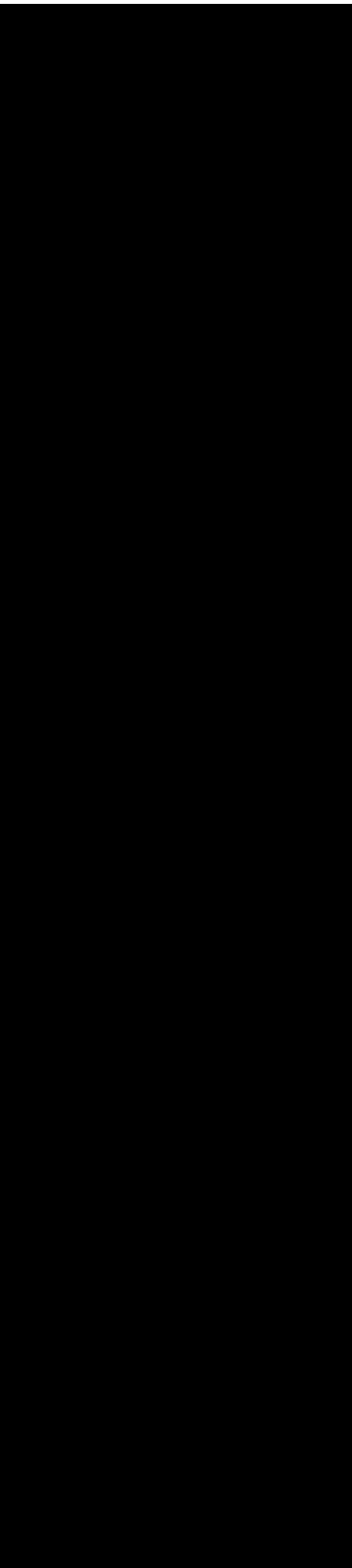

IGMP

Ruijie(config)# ip igmp snooping query-max-response-time <i>time</i>	IGMP 1-65535 10s
Ruijie(config)# no ip igmp snooping query-max-response-time	IGMP 10s

IGMP

15s

```
Ruijie# configure terminal
Ruijie(config)# ip igmp snooping query-max-response-time 15
```

VLAN

no

Ruijie(config)# ip igmp snooping vlan <i>vlan-id</i> mrouter interface <i>interface-id</i>	
Ruijie(config)# no ip igmp snooping vlan <i>vlan-id</i> mrouter interface <i>interface-id</i>	
Ruijie(config)# ip igmp snooping vlan <i>vlan-id</i> mrouter learn pim-dvmrp	VLAN
Ruijie(config)# no ip igmp snooping vlan <i>vlan-id</i> mrouter learn pim-dvmrp	

1/1 VLAN1

VLAN1

```
Ruijie# configure terminal
Ruijie(config)# ip igmp snooping vlan 1 mrouter interface
gigabitEthernet 1/1
Ruijie(config)# ip igmp snooping vlan 1 mrouter learn pim-dvmrp
Ruijie(config)# end
```

```
Ruijie# show ip igmp snooping mrouter
Vlan      Interface          State
-----  -
1  GigabitEthernet 1/1  static
1  GigabitEthernet 0/2  dynamic
Ruijie# show ip igmp snooping mrouter learn
Vlan      learn method
-----  -
1         pim-dvmrp
```

IP IP IP

IGMP Snooping

Ruijie(config)# ip igmp snooping ivgl	IGMP Snooping IVGL
Ruijie(config)# ip igmp snooping vlan <i>vlan-id</i> static <i>ip-addr</i> interface <i>interface-id</i>	<ul style="list-style-type: none"> • <i>vlan-id</i> vid • <i>ip-addr</i> • <i>interface-id</i>
Ruijie(config)# no ip igmp snooping vlan <i>vlan-id</i> static <i>ip-addr</i> interface <i>interface-id</i>	<ul style="list-style-type: none"> • <i>vlan-id</i> vid • <i>ip-addr</i> • <i>interface-id</i>

no ip igmp snooping vlan *vlan-id* static *ip-addr* interface *interface-id*

IGMP snooping

```
Ruijie# configure terminal
Ruijie(config)# ip igmp snooping vlan 1 static 233.3.3.4
interface GigabitEthernet 0/7
Ruijie(config)# end
Ruijie(config)# show ip igmp snooping gda
Abbr: M - mrouter
      D - dynamic
      S - static
VLAN Address                    Member ports
-----  -
```

1 233.3.3.4 GigabitEthernet 0/7(S)

```
Ruijie# configure terminal
Ruijie(config)# ip igmp snooping suppression enable
```

IGMP Profiles

```
IGMP Profiles                               " SVGL
" " " IGMP Filtering "
Profile
```

Ruijie(config)# ip igmp profile <i>profile-number</i>	IGMP Profile 1 1024 profile
Ruijie (config-profile)# permit deny	(permit deny deny / range /
Ruijie(config-profile)# range <i>low-address high_address</i>	IP IP IP range
Ruijie(config)# end	

```
IGMP profile no ip igmp profile profile number
profile range no range ip multicast
address
```

Profile

```
Ruijie(config)# ip igmp profile 1
Ruijie(config-profile)# permit
Ruijie(config-profile)# range 224.0.1.0 239.255.255.255
Ruijie(config-profile)# end
Ruijie# show ip igmp profile 1
Profile 1
Permit
range 224.0.1.0, 239.255.255.255
```

```
IGMP Profile permit 224.0.1.0
239.255.255.255 deny
```

IGMP Filtering

IGMP Filtering

IGMP Profile

IGMP Report

IGMP Profile

IGMP Report

IGMP Filtering

Ruijie(config)# interface <i>interface-id</i>	
Ruijie(config-if)# ip igmp snooping filter <i>profile-number</i>	Profile <i>profile number</i> 1- 1024 profile
Ruijie(config-if)# no ip igmp snooping filter	profile
Ruijie(config-if)# ip igmp snooping max-groups <i>number</i>	0 – 1024
Ruijie(config-if)# no ip igmp snooping max-groups	

IGMP Filtering

```

Ruijie# configure terminal
Ruijie(config)# interface fastEthernet 0/1
Ruijie(config-if)# ip igmp snooping filter 1
Ruijie(config-if)# ip igmp snooping max-groups 1000
Ruijie (config-if)#end
Ruijie #show ip igmp snooping interface fastEthernet 0/1
Interface           Filter profile number      max-group
-----
FastEthernet 0/1           1                          1000

```

IGMP Snooping

IGMP snooping

```

'
'
'
'
'
'      IGMP Profile
'
'      IGMP Filtering
    
```

IGMP Snooping

Ruijie# show ip igmp snooping	IGMP Snooping

show ip igmp snooping

IGMP Snooping

```

Ruijie# show ip igmp snooping
IGMP-snooping mode      : IVGL
SVGL vlan-id            : 1
SVGL profile number     : 0
Source port check: Disable
Source ip check: Disable
IGMP Fast-Leave: Disable
IGMP Report suppress: Disable
    
```

IGMP Snooping

IGMP Snooping

Ruijie# show ip igmp snooping statistics [vlan <i>vlan-id</i>]	IGMP Snooping
Ruijie# clear ip igmp snooping statistics	IGMP Snooping

show ip igmp snooping statistics

IGMP Snooping

```
Ruijie# show ip igmp snooping statistics
Current number of Gda-table entries: 1
Configured Statistics database limit: 1024
Current number of IGMP Query packet received : 1957
Current number of IGMPv1/v2 Report packet received: 5
Current number of IGMPv3 Report packet received: 4
Current number of IGMP Leave packet received: 1
```

```
GROUP Interface Last Last Report Leave
          report time reporter pkts pkts
-----
233.3.3.3 gil/1 00:02:40 1.1.1.1 3 1
```

IGMP Snooping

Ruijie# show ip igmp snooping mrouter	IGMP Snooping

show ip igmp snooping

IGMP Snooping

```
Ruijie# show ip igmp snooping mrouter
Vlan Interface State IGMP profile number
----
1 GigabitEthernet 0/7 static 1
1 GigabitEthernet 0/12 dynamic 0
```

GDA Group Destination Address

Ruijie# show ip igmp snooping gda-table	

GDA

```
Ruijie# show ip igmp snooping gda-table
Abbr: M - mrouter
```

```

        D - dynamic
        S - static
VLAN  Address                Member ports
-----
1      233.3.3.3              GigabitEthernet 0/7(S)
    
```

GDA Group Destination Address

Ruijie# clear ip igmp snooping statistics	

GDA

```
Ruijie# clear ip igmp snooping statistics
```

IGMP Snooping

Ruijie# show ip igmp snooping	IGMP Snooping

```

Ruijie(config)# show ip igmp snooping
IGMP-snooping mode      :IVGL
SVGL vlan-id            :1
SVGL profile number     :0
Source check port       :Disable
IGMP Fast-Leave: Disable
IGMP Report suppress: Disable
    
```

IGMP Profile

IGMP Profile

Ruijie# show ip igmp profile profile-number	IGMP Profile

IGMP Profile

```
Ruijie# show ip igmp profile 1
Profile      1
Permit
range 224.0.1.0, 239.255.255.255
```

IGMP Filtering

IGMP Filtering

Ruijie# show ip igmp snooping interface <i>interface-id</i>	IGMP Filtering

IGMP Filtering

```
Ruijie# show ip igmp snooping interface GigabitEthernet 0/7
Interface      Filter Profile number      max-groups
-----
GigabitEthernet 0/7          1                            4294967294
```

Bridge Protocol Data Units(BPDUs)

' ID Bridge ID Mac
' Root Path Cost
' ID Port ID
BPDU Bridge Protocol Data Units
01-80-C2-00-00-00

BPDU

' Root Bridge ID ID
'

ID

z

ID 7/-iY1-c2.bÜ Ÿ P00,@ 00000000 BPDU'

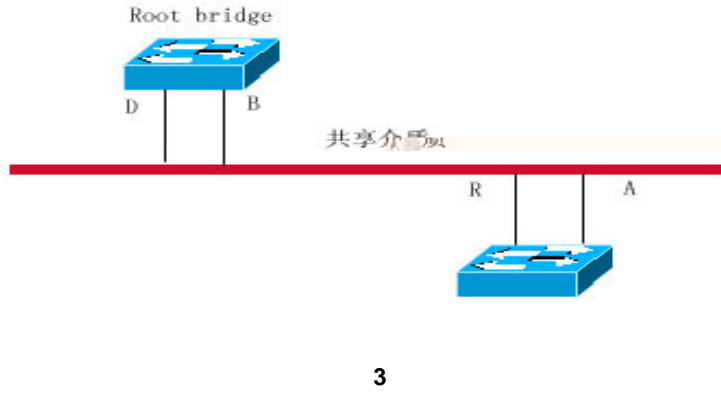
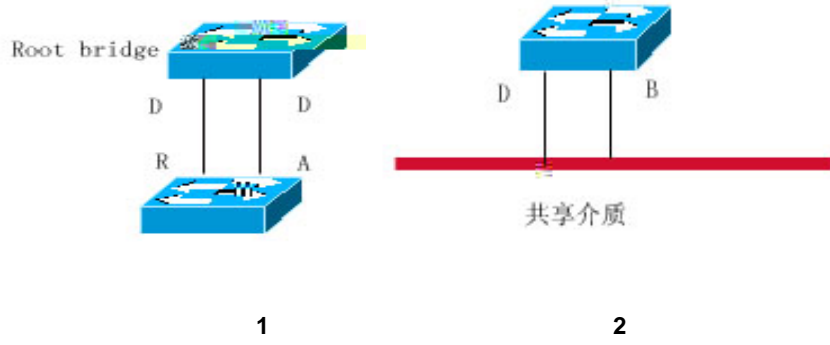

Port State

- ' Discarding Mac
 - ' Learning Mac
 - ' Forwarding Mac
- Forwarding Root Port Designated Port
 Discarding

			STP	RSTP				
	4		Switch A	B	C	bridge ID		Switch A
A	A	B		A	C		B	C
			Switch B	Switch B	Switch C			Switch

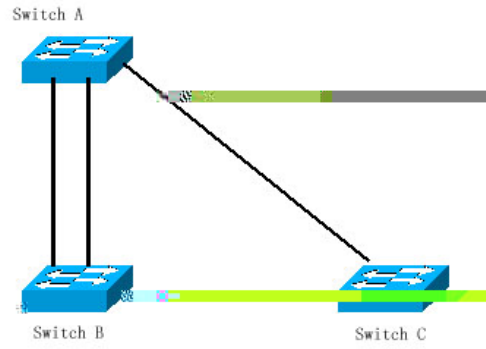

4

Switch	Spanning Tree		BPDUs
Root Bridge	Switch A	Switch B	Switch A
	Root Port		Alternate Port
Switch C	B	A	A
	Path Cost		A
	Switch C	B	Root port
	Alternate port		A
		Port Role	

5

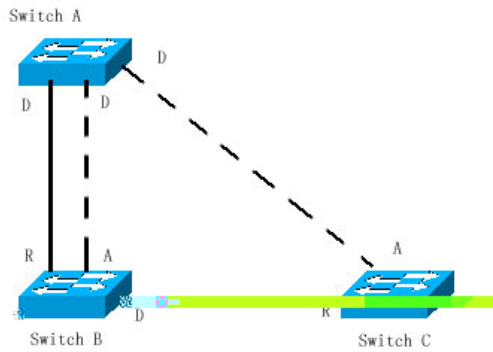

5

Switch A Switch B

6

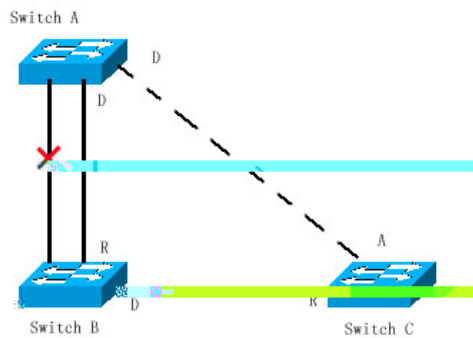

6

Switch B Switch C Switch C Alternate
 port Root port 7

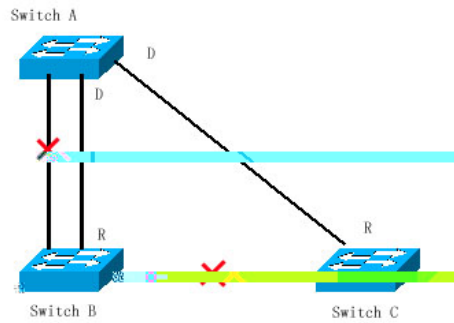

7

RSTP

RSTP " " Forwarding

STP Port Role 30 (Forward-Delay Time 2
 Forward-Delay Time 15) Forwarding

Forwarding Root Port Designated Port 30
 50

RSTP Forwarding 8 Switch A RSTP
 "Proposal" Switch B Switch A Switch A
 Root Port Forwarding Root Port Switch
 A "Agree" Switch A Designated Port " " Forwarding
 Switch B Designated Port "Proposal"
 RSTP

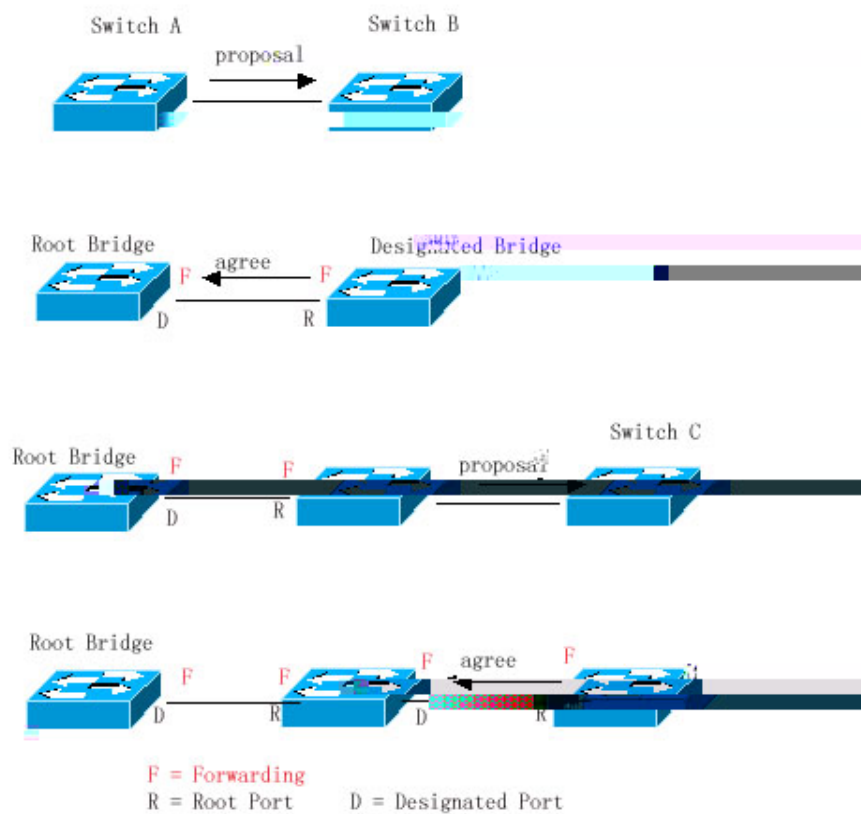

8

r

“ ”
”

“Point-to-point Connect

9

“ ” “ ”

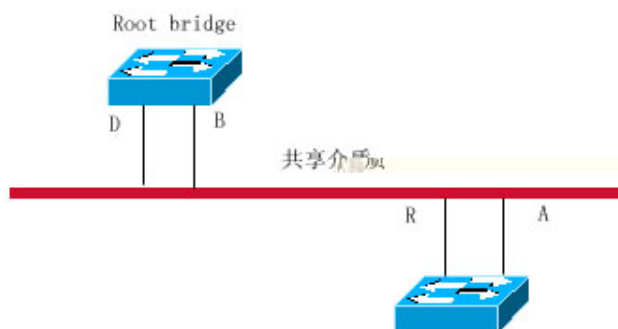

9

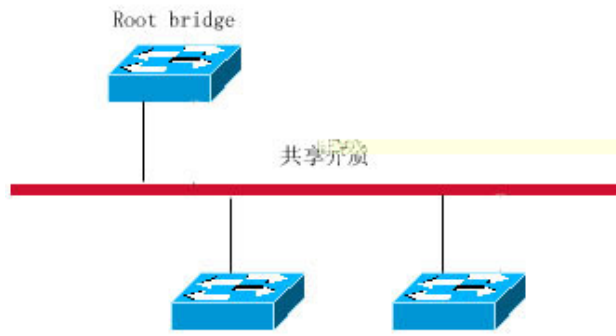

10

“ ”

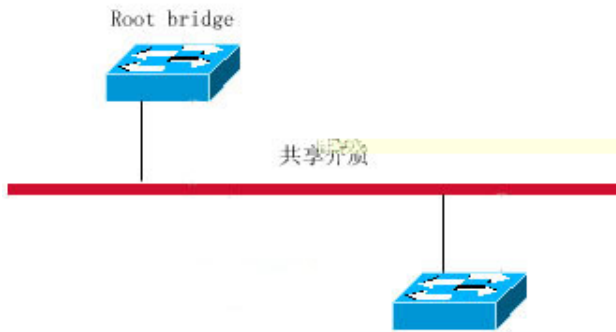

11

RSTP STP

RSTP STP RSTP BPDU STP
 STP Forwarding 30 Forwarding
 RSTP
 RSTP STP 12 Switch A
 RSTP Switch B STP Switch A
 STP STP BPDU Switch C
 RSTP Switch A STP BPDU Switch C
 STP RSTP STP
 RSTP Protocol-migration RSTP BPDU(
 RSTP) Switch A RSTP BPDU Switch C
 RSTP RSTP

13

Protocol Migration

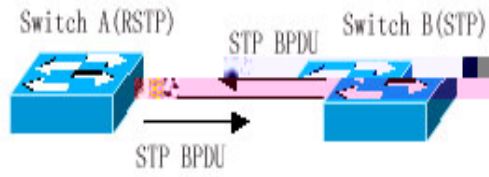

12

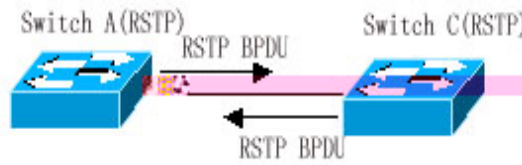

13

MSTP

MSTP MSTP STP RSTP
 RSTP FORWARDING
 Vlan

14

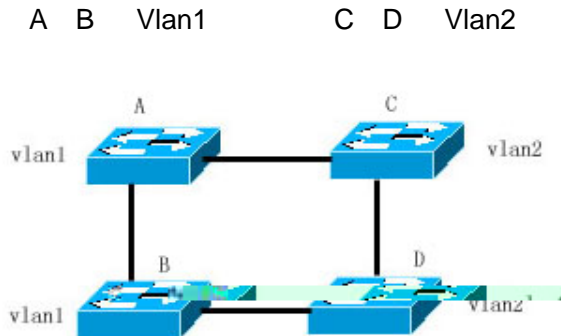

14

A C D B A B
 A B DISCARDING 15
 C D Vlan1 Vlan1 A Vlan1
 B Vlan1

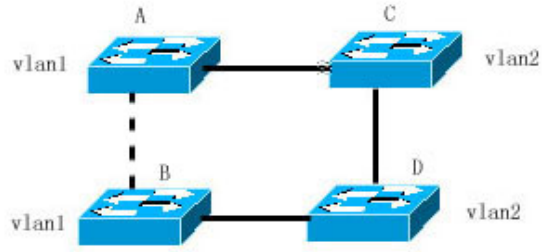

15

	MSTP			
Instance	Instance	IST	Internal Spanning-tree	Vlan
			MST Region	MST Region
MST region		CST	Common Spanning Tree	
	MSTP		16	A B

' MST Revision Number 16bit MSTP Region
'

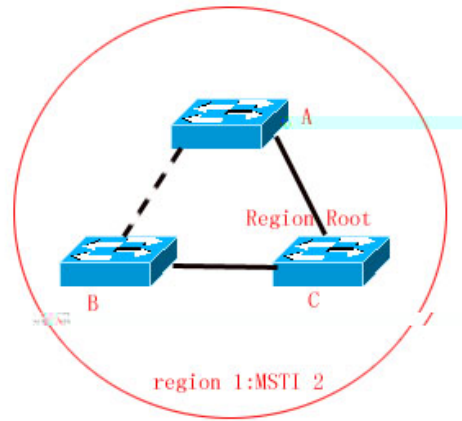

19

MSTP	MSTP	Vlan	MSTP	Vlan	Path Cost	Priority
MSTP	Region	1	1	1	200	1

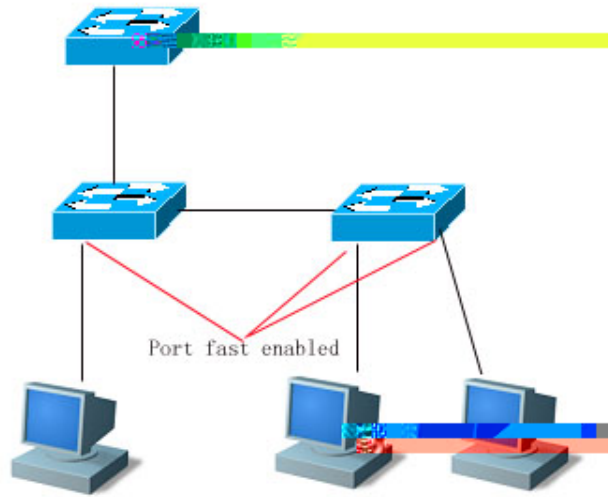

21

Port Fast
Disabled

BPDU
STP

Port Fast Operational State
Forwarding

(AutoEdge)

AutoEdge

(3)

MSTP

Root Guard

Root Guard

Root Guard

root-inconsistent (blocked)

blocked

ROOT Guard
none

spanning-tree guard

r

1) ROOT Guard

MSTP

Spanning Tree

Spanning Tree

Enable State	Disable STP
STP MODE	MSTP
STP Priority	32768
STP port Priority	128
STP port cost	
Hello Time	2
Forward-delay Time	15
Max-age Time	20
Path Cost	
Tx-Hold-Count	3
Link-type	
Maximum hop count	20
vlan	vlan 0

spanning-tree reset Spanning Tree (Span)

Spanning Tree

Spanning-tree MSTP

Spanning-tree

Spanning Tree

Ruijie# configure terminal	
Ruijie(config)# spanning-tree	Spanning Tree
Ruijie(config)# end	

Ruijie# show spanning-tree	
Ruijie# copy running-config startup-config	

Spanning Tree

no spanning-tree

Spanning Tree

802.1

STP RSTP MSTP

Spanning Tree

Spanning Tree

MSTP

RSTP STP

MSTP Region

MSTP

Spanning Tree

Ruijie# configure terminal	
Ruijie(config)# spanning-tree mode mstp/rstp/stp	Spanning Tree
Ruijie(config)# end	
Ruijie# show spanning-tree	
Ruijie# copy running-config startup-config	

Spanning Tree

no spanning-tree mode

Switch Priority

Instance

Instance

Region

CIST

Instance 0

```
Bridge ID          16          4096          0 4096
8192 12288 16384 20480 24576 28672 32768 36864 40960 45056
49152 53248 57344 61440          32768
```

Ruijie# configure terminal	

```
Ruijie(config)# 09284D1D17 1 Tf9TT2Tj/TT0 1 Tf41 Tf80.85.42 6[(inst)8 z7ce-id073C1214472
```

Ruijie(config-if)# spanning-tree [mst <i>instance-id</i>] port-priority <i>priority</i>	instance instance instance 0 <i>instance-id</i> 0 64 <i>priority</i> interface 0 240 16 128
Ruijie(config-if)# end	
Ruijie# show spanning-tree [mst <i>instance-id</i>] interface <i>interface-id</i>	
Ruijie# copy running-config startup-config	

no spanning-tree mst *instance-id* port-priority

Ruijie# show spanning-tree [mst <i>instance-id</i>] interface <i>interface-id</i>	
Ruijie# copy running-config startup-config	

no spanning-tree mst cost

Path Cost

path cost method

Path Cost Path
 Cost IEEE 802.1d IEEE 802.1t Path Cost
 802.1d short 1—65535 802.1t
 long (1—200,000,000) Path Cost
 IEEE 802.1t

Path Cost

	Interface	IEEE 802.1d short	IEEE 802.1t long
		100	2000000

Ruijie# show running-config	
Ruijie# copy running-config startup-config	

no spanning-tree pathcost method

Hello Time

BPDU

2

Hello Time

Ruijie# configure terminal	
Ruijie(config)# spanning-tree hello-time seconds	hello_time 1 10 2
Ruijie(config)# end	
Ruijie# show running-config	
Ruijie# copy running-config startup-config	

no spanning-tree hello-time

Forward-Delay Time

15

Forward-Delay Time

Ruijie# configure terminal	
Ruijie(config)# spanning-tree forward-time seconds	forward delay time 4 30 15
Ruijie(config)# end	

Ruijie# show running-config	
Ruijie# copy running-config startup-config	

no spanning-tree forward-time

Max-Age Time

BPDU

20

Max-Age Time

Ruijie# configure terminal	
Ruijie(config)# spanning-tree tx-hold-count <i>numbers</i>	1 10 BPDUs 3
Ruijie(config)# end	
Ruijie# show running-config	
Ruijie# copy running-config startup-config	

no spanning-tree tx-hold-count

link-type

```

Ruijie# configure terminal
Ruijie(config)# spanning-tree link-type point-to-point
Ruijie(config)# spanning-tree link-type shared
Ruijie(config)# spanning-tree link-type
Ruijie(config)# spanning-tree link-type
    
```

Ruijie# configure terminal	
Ruijie(config)# interface <i>interface-id</i>	
Ruijie(config-if)# spanning-tree link-type <i>point-to-point/shared</i>	interface " " " " FORWARDING
Ruijie(config-if)# end	
Ruijie# show running-config	
Ruijie# copy running-config startup-config	

no spanning-tree link-type

Protocol Migration

RSTP STP

Ruijie# clear spanning-tree detected-protocols	
Ruijie# clear spanning-tree detected-protocols interface interface-id	

MSTP Region

```

MSTP Region
Name          Revision Number      Instance—Vlan
0             0 64 Instance         Vlan      Vlan      Instance
0             Vlan              Instance
MSTP
STP           Instance—Vlan
MSTP

```

MSTP Region

Ruijie# configure terminal	
Ruijie(config)# spanning-tree mst configuration	MST
Ruijie(config-mst)# instance instance-id vlan vlan-range	<pre> vlan MST instance instance-id 0 64 vlan-range 1 4094 instance 1 vlan 2-200 vlan 2 vlan 200 instance 1 instance 1 vlan 2,20,200 vlan 2 vlan 20 vlan 200 instance 1 no vlan instance vlan instance 0 </pre>
Ruijie(config-mst)# name name	MST 32
Ruijie(config-mst)# revision version	MST revision number 0 65535 0
Ruijie(config-mst)# show	MST

MSTP

Ruijie(config)# end	
Ruijie# show running-config	
Ruijie# copy running-config startup-config	

no spanning-tree max-hops

MSTI BPDU

Ruijie# configure terminal	
Ruijie(config)# interface <i>interface-id</i>	
Ruijie(config-if)# spanning-tree compatible enable	
Ruijie(config-if)# end	
Ruijie# show running-config	
Ruijie# copy running-config startup-config	

no spanning-tree compatible enable

MSTP

(AutoEdge)

Port Fast

Port Fast

Forwarding

BPDU

Port Fast

Operational State disabled STP Forwarding

Port Fast

Ruijie# configure terminal	
Ruijie(config)# interface <i>interface-id</i>	interface interface Aggregate Link
Ruijie(config-if)# spanning-tree portfast	interface portfast
Ruijie(config-if)# end	
Ruijie# show spanning-tree interface <i>interface-id</i> portfast	
Ruijie# copy running-config startup-config	

Port Fast Interface **spanning-tree portfast**
disable

spanning-tree portfast default

Portfast

(3) BPDUs
BPDU Port Fast Operational State disabled

Autoedge

Ruijie# configure terminal	
Ruijie(config)# interface <i>interface-id</i>	interface interface Aggregate Link
Ruijie(config-if)# spanning-tree autoedge	interface autoedge
Ruijie(config-if)# end	
Ruijie# show spanning-tree interface <i>interface-id</i>	

Ruijie# copy running-config startup-config	
---	--

Autoedge Interface **spanning-tree autoedge disabled**

BPDU Guard

BPDU Guard BPDU Error-disabled

BPDU Guard

Ruijie# configure terminal	
Ruijie(config)# spanning-tree portfast Bpduguard default	BPDU guard
Ruijie(config)# interface interface-id	interface interface Aggregate Link
Ruijie(config-if)# spanning-tree portfast	interface portfast bpduguard
Ruijie(config-if)# end	
Ruijie# show running-config	
Ruijie# copy running-config startup-config	

BPDU Guard **no spanning-tree portfast bpduguard default**

Interface BPDU Guard Interface **spanning-tree bpduguard enable** **spanning-tree bpduguard disable** BPDU guard

BPDU Filter

BPDU Filter BPDU
BPDU Filter

--	--

Ruijie# configure terminal	
Ruijie(config)# spanning-tree portfast bpdudfilter default	BPDU filter
Ruijie(config)# interface <i>Interface-id</i>	interface interface Aggregate Link
Ruijie(config-if)# spanning-tree Portfast	interface portfast bpdudfilter

Ruijie(config-if)# **end**

Ruijie# copy running-config startup-config	
---	--

bpdu mac

no bpdu src-mac-check

Root Guard

ROOT Guard

configure terminal	
Ruijie(config)# interface Interface-id	interface interface Aggregate Link
Ruijie(config-if)# spanning-tree	

Ruijie(config)# interface <i>Interface-id</i>	interface interface	Aggregate Link
Ruijie(config-if)# spanning-tree guard loop	interface	

Ruijie# **show spanning-tree mst**

1) **Switch A**

Gi 0/1 Gi 0/2 Trunk VLAN 2 VLAN 3

Ruijie# **configure terminal**

Enter configuration commands, one per line. End with CNTL/Z.

Ruijie(config)# **interface** *gigabitEthernet 0/1*

Ruijie(config-if)# Enter cconfig-if)#)# exit1 Tf 0 Tc 11.4 0 Td2 Ruijie(config-if)# interface

MSTP

```
Ruijie(config-vlan)# exit  
Ruijie(config)# vlan 3  
Ruijie(config-vlan)# exit
```

#	MSTP	VLAN 2	Instance 1	VLAN 3
Instance 2	MST	ruijie		

```
BPDUGuard : enabled
BPDUFilter : Disabled
LoopGuardDef : Disabled
##### mst 0 vlans map : 1, 4-4094
BridgeAddr : 00d0.f82a.aa8e
Priority: 32768
TimeSinceTopologyChange : 0d:0h:19m:44s
TopologyChanges : 1
DesignatedRoot : 1000.00d0.f822.33aa
RootCost : 0
RootPort : 1
CistRegionRoot : 1000.00d0.f822.33aa
CistPathCost : 200000
##### mst 1 vlans map : 2
BridgeAddr : 00d0.f82a.aa8e
Priority: 32768
TimeSinceTopologyChange : 0d:0h:1m:46s
TopologyChanges : 7
DesignatedRoot : 1001.00d0.f834.56f0
RootCost : 200000
RootPort : 2
##### mst 2 vlans map : 3
BridgeAddr : 00d0.f82a.aa8e
Priority: 4096
TimeSinceTopologyChange : 0d:0h:1m:44s
TopologyChanges : 5
DesignatedRoot : 1002.00d0.f82a.aa8e
RootCost : 0
RootPort : 0
```

```
# Fa 0/1
```

```
Ruijie# show spanning-tree interface fastEthernet 0/1
PortAdminPortFast : Disabled
PortOperPortFast : Disabled
PortAdminAutoEdge : Enabled
PortOperAutoEdge : Disabled
PortAdminLinkType : auto
PortOperLinkType : point-to-point
PortBPDUGuard : Disabled
PortBPDUFilter : Disabled
PortGuardmode : None
##### MST 0 vlans mapped :1, 4-4094
PortState : forwarding
PortPriority : 128
PortDesignatedRoot : 1000.00d0.f822.33aa
PortDesignatedCost : 0
```

PortDesignatedBridge :1000.00d0.f822.33aa
PortDesignatedPort : 8002
PortForwardTransitions : 1
PortAdminPathCost : 200000
PortOperPathCost : 200000
Inconsistent states : normal
PortRole : rootPort
MST 1 vlans mapped :2
PortState : discarding
PortPriority : 128
PortDesignatedRoot : 1001.00d0.f834.56f0
PortDesignatedCost : 0
PortDesignatedBridge :8001.00d0.f822.33aa
PortDesignatedPort : 8002
PortForwardTransitions : 5
PortAdminPathCost : 200000
PortOperPathCost : 200000
Inconsistent states : normal
PortRole : alternatePort
MST 2 vlans mapped :3
PortState : forwarding
PortPriority : 128
PortDesignatedRoot : 1002.00d0.f82a.aa8e
PortDesignatedCost : 0
PortDesignatedBridge :1002.00d0.f82a.aa8e
PortDesignatedPort : 8001
PortForwardTransitions : 1
PortAdminPathCost : 200000
PortOperPathCost : 200000
Inconsistent states : normal
PortRole : designatedPort

SPAN disabled port SPAN
Show monitor session *session number*
SPAN SPAN

SPAN

SPAN

SPAN

SPAN

MAC MAC VLAN ID TTL

SPAN

() switched port routed port AP
SPAN

1) switched port routed port AP

2)

3)

4) VLAN VLAN

SPAN ()

' switched port routed port AP

SPAN

r
S3760 tag

SPAN Traffic

SPAN

BPDU

SPAN

SPAN

Spanning Tree Protocol(STP)—SPAN

STP

SPAN

SPAN

:

SPAN

SPAN	

SPAN

SPAN

disabled port

SPAN

no monitor session *session_number*

SPAN

SPAN

STP

SPAN

1)

VLAN

2) VLAN

3)

r

S3760

SPAN

SPAN



Ruijie(config)# **no monitor**

session *session_number* **source**

interface-id

interface *interface-id* [| -]

R6a€sÀÄöÒèÛ n, ð

[**both** | **rx** | **tx**]

	Source Port	Reflector port
	Reflector port	
		Trunk
	Destination port	

VLAN VLAN VLAN Remote VLAN

r

- 1) Vlan
- 2) AP
- 3) Remote-span Vlan Vlan 1 Private Vlan
- 4) Remote-span Vlan GVRP
- 5) STP remote vlan bpd filter
 block Remote vlan bpd filter bpd

RSPAN

'
 ' Remote VLAN
 ' Remote VLAN

RSPAN

'
' Remote VLAN

[REDACTED]		
Ruijie# configure terminal		

```

tag
S3760 CPU RLDP DHCP

```

Ruijie# configure	
Ruijie(config)# vlan <i>vlan-id</i>	Vlan
Ruijie(config-vlan)# remote-span	Vlan remote-span Vlan
Ruijie(config-vlan)# exit	

Ruijie# configure	
Ruijie(config)# vlan <i>vlan-id</i>	Vlan
Ruijie(config-vlan)# remote-span	Vlan remote-span Vlan
Ruijie(config-vlan)# exit	
Ruijie(config)# monitor session <i>session_num</i> remote-destination	
Ruijie(config)# monitor session <i>session-num</i> destination remote vlan <i>vlan-id</i> interface <i>interface-name</i> [switch]	Remote VLAN Switch
Ruijie(config)# interface <i>interface-name</i>	
Ruijie(config-if)# {switchport access vlan <i>vid</i> switchport trunk native vlan <i>vid</i> }	vid remote-span vlan vid access remote-span vlan trunk remote-span vlan remote-span vlan native vlan

r

```

S3760 RSPAN switch
( monitor session session-num destination remote vlan vlan-id

```

RSPAN

interface *interface-name* [**switch**)

RSPAN



Ruijie#

```
Ruijie(config)#Interface fastEthernet 0/3
Ruijie(config-if)#switchport mode trunk
Ruijie(config-if)#switchport trunk allowed vlan add 7
Ruijie(config-if)# exit
Ruijie(config)# monitor session 1 remote-source
Ruijie(config)# monitor session 1 source interface
fastEthernet 0/2
Ruijie(config)#Interface fastEthernet 0/1
Ruijie(config-if)#switchport access vlan 7
Ruijie(config)#monitor session 1 destination remote vlan 7
reflector-port interface fastEthernet 0/1 switch
```

```
Ruijie# configure
Ruijie(config)# vlan 7
Ruijie(config-vlan)# remote-span
Ruijie(config-vlan)# exit
Ruijie(config)#Interface fastEthernet 0/3
Ruijie(config-if)#switchport mode trunk
Ruijie(config-if)#switchport trunk allowed vlan add 7
Ruijie(config-if)#exit
Ruijie(config)#Interface fastEthernet 0/4
Ruijie(config-if)#switchport mode trunk
Ruijie(config-if)#switchport trunk allowed vlan add 7
```

```
Ruijie# configure
Ruijie(config)# vlan 7
Ruijie(config-vlan)# remote-span
Ruijie(config-vlan)# exit
Ruijie(config)#Interface fastEthernet 0/4
Ruijie(config-if)#switchport mode trunk
Ruijie(config-if)#switchport trunk allowed vlan add 7
Ruijie(config-if)# exit
Ruijie(config)# monitor session 1 remote- destination
Ruijie(config)#monitor session 1 destination remote vlan 7
interface fastEthernet 0/1 switch
```

IP

IP

CNNIC
ICANN, Internet Corporation for Assigned
Names and Numbers

IP
Assigned
IP

A	0.0.0.0	
	1.0.0.0~126.0.0.0	
	127.0.0.0	
B	128.0.0.0~191.254.0.0	
	191.255.0.0	
C	192.0.0.0	
	192.0.1.0~223.255.254.0	
	223.255.255.0	
D	224.0.0.0~239.255.255.255	
E	240.0.0.0~255.255.255.254	
	255.255.255.255	

IP
RFC 1918

	IP	
A	10.0.0.0~10.255.255.255	1 A
B	172.16.0.0~172.31.255.255	16 B
C	192.168.0.0~192.168.255.255	256 C

IP TCP/UDP

RFC 1166

IP

IP

IP

```
'      IP
'          ARP
'      IP
'      IP
'
```

IP

```
      IP          IP          IP
      IP
      IP
```



Ruijie(config-if)# **ip address** *ip-address mask*

IP

II SNAP
 RARP ARP RARP MAC
 IP RARP

' ARP
 ' ARP
 ' ARP

ARP

ARP IP MAC ARP IP ARP

ARP

Ruijie(config)# arp ip-address mac-address arp-type	ARP arp-type arpa
Ruijie(config)# no arp ip-address	ARP

ARP

ARP Ethernet II ARPA

ARP

ARP IP MAC ARP ARP
 ARP ARP ARP
 ARP

Ruijie(config-if)# arp timeout seconds	ARP 0-2147483 0
Ruijie(config-if)# no arp timeout	

3600 1

IP

IP IP IP
IP IP IP
IP IP IP

Ruijie(config)# no ip routing	IP
Ruijie(config)# ip routing	IP

1
" 1" 2
32 " 1" IP
IP
IP

IP

RFC 919 RFC 922

'
' IP

IP IP IP
172.16.16.255

IP

IP " 1"

Ruijie(config-if)# ip directed-broadcast [<i>access-list-number</i>]	
Ruijie(config-if)# no ip directed-broadcast	

IP

" 1" 255.255.255.255

255.255.255.255

Ruijie(config-if)# ip broadcast-address <i>ip-address</i>	
Ruijie(config-if)# no ip broadcast-address	

IP

,

,

- 1) ARP
- 2) IP
- 3)

Ruijie# clear arp-cache	ARP
Ruijie# clear ip route { <i>network [mask] *</i> }	IP

IP

Ruijie# show arp	ARP
Ruijie# show ip arp	IP ARP
Ruijie# show ip interface [<i>interface-type</i> <i>interface-number</i>]	IP
Ruijie# show ip route [<i>network</i> [<i>mask</i>]	
Ruijie# show ip route	
Ruijie# ping <i>ip-address</i> [length <i>bytes</i>] [ntimes <i>times</i>] [timeout <i>seconds</i>]	

IP

IP

IP

IP

IP

1

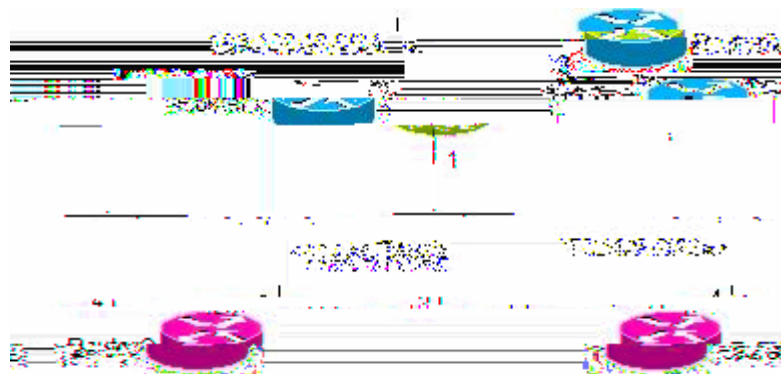

1 IP

- ' ICMP
- ' ICMP
- ' ICMP
- ' IP MTU
- ' IP

ICMP

IP

ICMP
ICMP
ICMP

Ruijie(config-if)# ip unreachable	ICMP
Ruijie(config-if)# no ip unreachable	ICMP

ICMP

ICMP

ICMP

Ruijie(config-if)# ip redirects	ICMP
Ruijie(config-if)# no ip redirects	ICMP

ICMP

ICMP
ICMP
ICMP

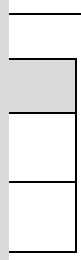

U IP

Ruijie(config-if)# ip mtu bytes	MTU	68~1500
Ruijie(config-if)# no ip mtu		

IP

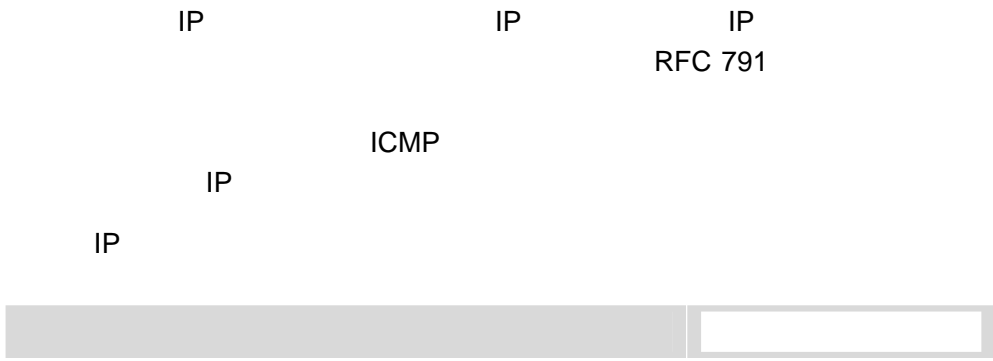

DHCP

DHCP

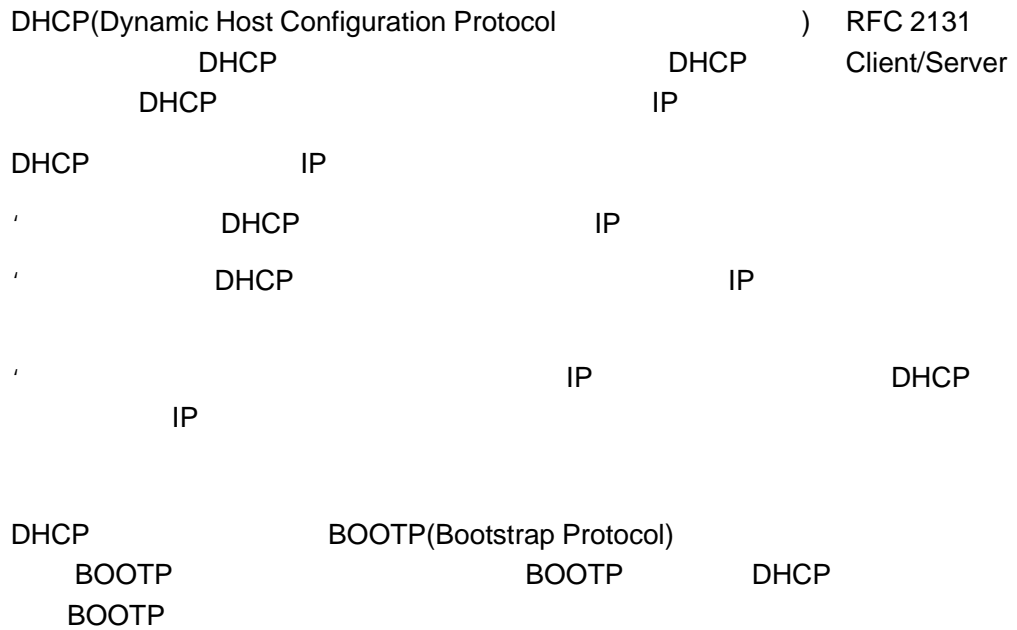

3) DHCPREQUEST IP
4) DHCP DHCPACK

/

DHCP DHCP DHCPOFFER
DHCPOFFER DHCPOFFER DHCP DHCPOFFER
DHCP

DHCP DHCPREQUEST
DHCPOFFER DHCP
OFFER IP
DHCP DHCPOFFER
DHCPOFFER
DHCP DHCPOFFER DHCP
DHCPOFFER
DHCP
DHCP

,

,

,

DHCP

DHCP

DHCP DHCP IP
DHCP
IP

r

FR PPP HDLC DHCP

DHCP

DHCP

DHCP

DHCP

DHCP

Ruijie(config)# ip dhcp excluded-address <i>low-ip-address [high-ip-address]</i>	IP DHCP
Ruijie(config)# no ip dhcp excluded-address <i>low-ip-address [high-ip-address]</i>	

DHCP

á

Ruijie(config)# ip dhcp pool <i>dhcp-pool</i>	
--	--

“Ruijie(dhcp-config)#”

DHCP

Ruijie (dhcp-config)# bootfile <i>filename</i>	

IP DHCP IP

Ruijie(dhcp-config)# default-router <i>address</i> [<i>address2...address8</i>]	

DHCP

1

Ruijie(dhcp-config)# lease { <i>days</i> [<i>hours</i>] [<i>minutes</i>] infinite }	

--	--

Ruijie(dhcp-config)# domain-name <i>domain</i>	
---	--

DHCP DNS

Ruijie(dhcp-config)# dns-server <i>address</i> [<i>address2...address8</i>]	DNS

NetBIOS WINS

WINS TCP/IP NetBIOS IP
WINS Windows NT WINS WINS
 WINS WINS WINS
 WINS WINS

DHCP NetBIOS WINS

--

DHCP

DHCP

DHCP

DHCP

:

Ruijie(dhcp-config)# network <i>network-number mask</i>	DHCP

/

DHCP

DHCP

ID

[

]

IP

MAC

1

DHCP

IP

MAC

2

DHCP

DHCP

IP

IP

MAC

DHCP

IP

MAC

MAC

MAC

RFC 1700

“Address Resolution Protocol Parameters”

“01”

Ruijie(config-if)# ip address dhcp	DHCP IP

DHCP

DHCP

- 1 DHCP
- 2 debug
- 3 DHCP

Ruijie# clear ip dhcp binding { <i>address</i> * }	DHCP
Ruijie# clear ip dhcp conflict { <i>address</i> * }	DHCP
Ruijie# clear ip dhcp server statistics	DHCP

DHCP

Ruijie# debug ip dhcp server [events packet]	DHCP

DHCP

Ruijie# show ip dhcp binding [address]	DHCP
Ruijie# show ip dhcp conflict	DHCP
Ruijie# show ip dhcp server statistics	DHCP

DHCP

DHCP

- 1 debug

2 DHCP

DHCP

Ruijie# debug ip dhcp client	DHCP

DHCP

Ruijie# show dhcp lease	DHCP

3

```
'
'
' DHCP
```

```

                                net172                172.16.1.0/24
172.16.16.254                rg.com                172.16.1.253 WINS
172.16.1.252 NetBIOS                30
172.16.1.2~172.16.1.100

ip dhcp excluded-address 172.16.1.2 172.16.1.100
!
ip dhcp pool net172
network 172.16.1.0 255.255.255.0
default-router 172.16.1.254
domain-name rg.com
dns-server 172.16.1.253
netbios-name-server 172.16.1.252
netbios-node-type h-node
lease 30
```

```

                                MAC                00d0.df34.32a3    DHCP                IP
172.16.1.101                255.255.255.0                Billy.rg.com
172.16.1.254 WINS                172.16.1.252    NetBIOS
```

DHCP

```
ip dhcp pool Billy
host 172.16.1.101 255.255.255.0
hardware-address 00d0.df34.32a3 ethernet
client-name Billy
default-robt0r 172.16.1.254
domain-name rg.com
dns-serv0r 172.16.1.253
netbios-name-serv0r 172.16.1.252
netbios-node-type h-node
```

DHCP

FastEthernet 0/0 DHCP

```
int0rface FastEthernet0/0
ip address dhcp
```

DHCP Relay

DHCP

DHCP

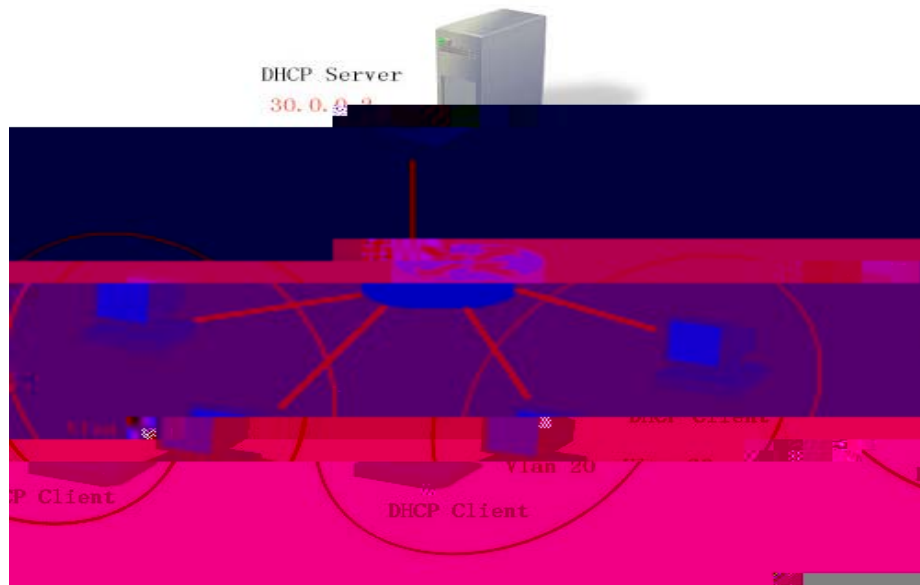

Circuit ID

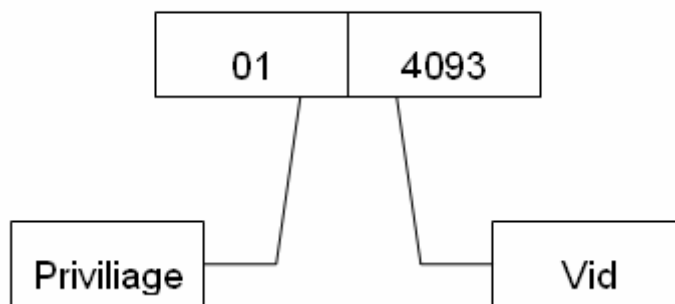

2

2. relay agent information option82 option
 DHCP relay DHCP
 option82 option

Agent Circuit ID

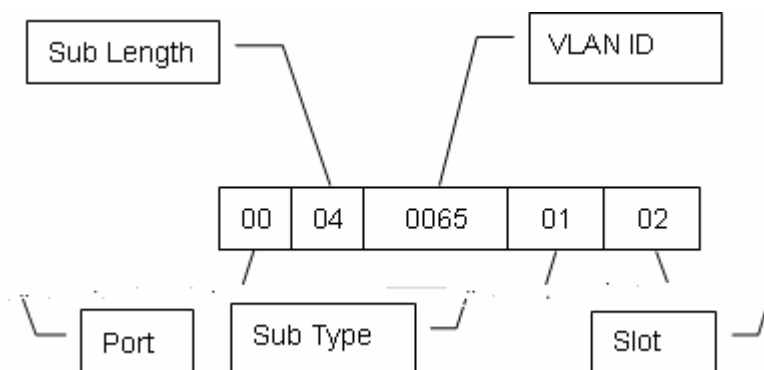

3

Agent Remote ID

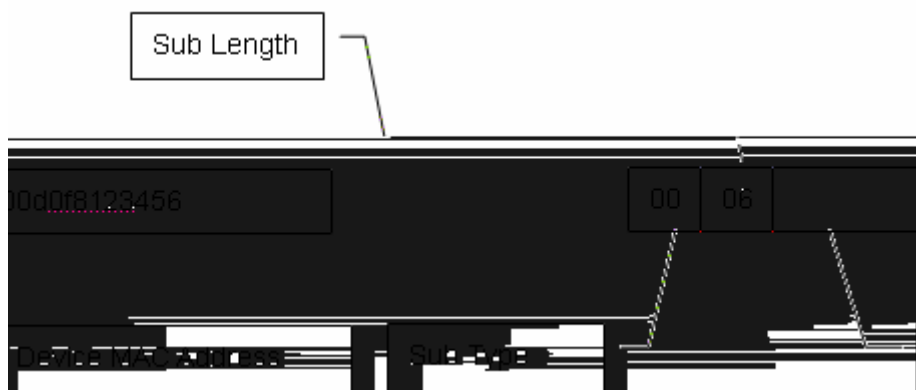

4

DHCP Relay

Ruijie(config-if)# no IP helper-address [vrf] A.B.C.D	DHCP
---	------

DHCP option dot1x

DHCP Relay Agent Information

information option dot1x IP **ip dhcp relay**
DHCP relay option dot1x

Ruijie(config)# ip dhcp relay check server-id	DHCP relay check server-id
Ruijie(config)# no ip dhcp relay check server-id	DHCP relay check server-id

DHCP relay suppression

ip dhcp relay suppression DHCP relay suppression
DHCP relay

Ruijie(config-if)# ip dhcp relay suppression	DHCP relay suppression
Ruijie(config-if)# no ip dhcp relay suppression	DHCP relay suppression

DHCP

```

dhcp relay
Ruijie# configure terminal
Ruijie(config)# service dhcp // dhcp relay
Ruijie(config)# ip helper-address 192.18.100.1 //

Ruijie(config)# ip helper-address 192.18.100.2 //

Ruijie(config)# interface GigabitEthernet 0/3
Ruijie(config-if)# ip helper-address 192.18.200.1 //

Ruijie(config-if)# ip helper-address 192.18.200.2 //

Ruijie(config-if)# end

```

DHCP relay

dot1x option82 vlan relay option
vlan relay

DHCP option dot1x

1. AAA/802.1x
2. 802.1x

```
password 7 0137  
line vty 3 4  
login  
end
```

DNS

DNS

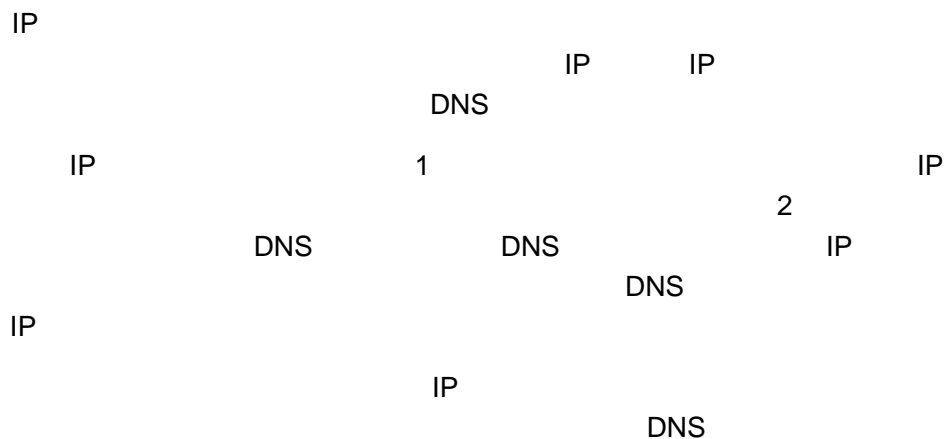

DNS

DNS

DNS	
DNS IP	
DNS	6

DNS

DNS

Ruijie(config)# ip domain-lookup	DNS

no ip domain-lookup DNS

Ruijie(config)# **ip domain-lookup**

DNS Server

DNS

DNS

DNS
ip-address

no ip name-server [*ip-address*]

Ruijie(config)# ip name-server <i>ip-address</i>	DNS Server IP DNS Server Server Server DNS 6

IP

IP

IP

IP

IP

Ruijie(config)# ip host <i>host-name ip-address</i>	IP
no	IP
	clear host clear host *

Ruijie# **clear host** V ð "Î %A #ÙFÃ€ç,Å€

Ruijie# show hosts	DNS

```
Ruijie# show hosts
DNS name server :
192.168.5.134 static
    host          type          address
www.163.com      static        192.168.5.243
www.ruijie.com   dynamic       192.168.5.123
```

Ping

```
Ruijie# ping www.ietf.org
Resolving host[www.ietf.org]
Sending 5,100-byte ICMP Echos to 192.168.5.123,
timeout is 2000 milliseconds.
!!!!!
Success rate is 100 percent(5/5)
Minimum = 1ms Maximum = 1ms, Average = 1ms
```

(SNTP)

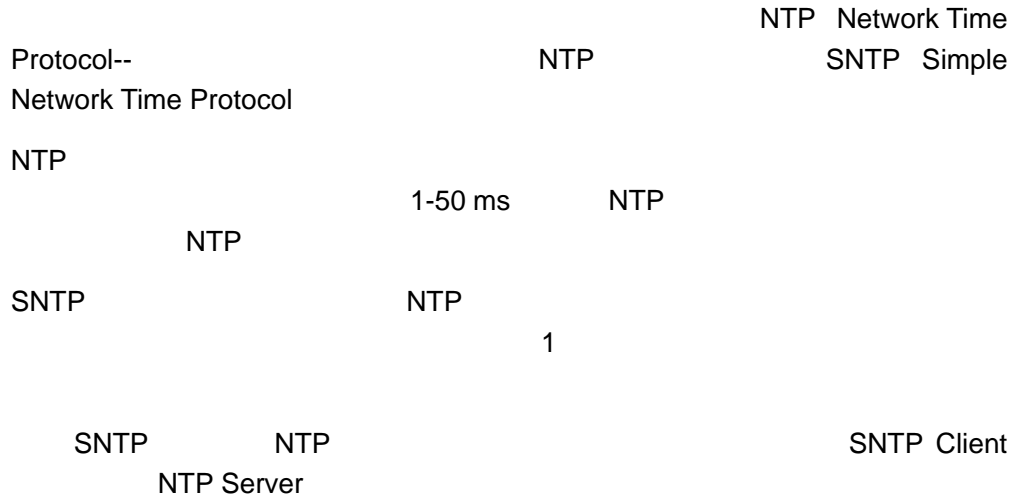

SNTP

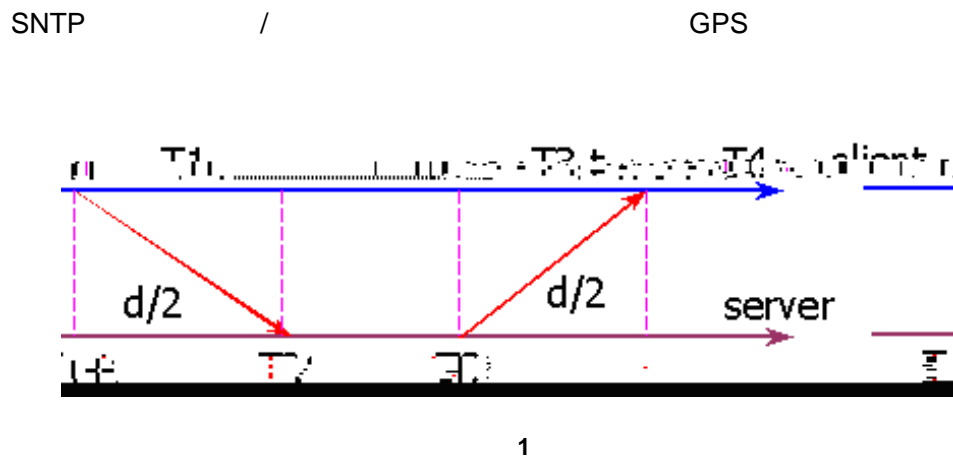

Originate Timestamp	T1	time request sent by client
Receive Timestamp	T2	time request received at server
Transmit Timestamp	T3	time reply sent by server
Destination Timestamp	T4	time reply received at client

T1 () Originate Timestamp

T2 () Receive

Timestamp
 T3 () Transmit
 Timestamp
 T4 () Destination
 Timestamp
 T
 d

$$T2 = T1 + t + d / 2;$$

$$T2 - T1 = t + d / 2;$$

$$T4 = T3 - t + d / 2;$$

$$T3 - T4 = t - d / 2;$$

$$d = (T4 - T1) - (T3 - T2);$$

$$t = ((T2 - T1) + (T3 - T4)) / 2;$$

t d SNTP Client

T4 + t

SNTP

SNTP

SNTP

SNTP

SNTP		Disable	SNTP
NTP Server	IP	0	

SNTP	1800s
	+8

SNTP

SNTP

```

1)
Ruijie# config

2)      SNTP      "      "
          (      "      "
          5 )

Ruijie(config)# sntp enable

3)

Ruijie(config)# end

4)

Ruijie# show running-config

5)

Ruijie# copy running-config startup-config

          SNTP      no sntp enable      SNTP

```

NTP Server

```

          SNTP      NTP      SNTP Client
NTP Server      NTP Server
          NTP Server

          NTP server      http://www.time.edu.cn/      http://www.ntp.org/

          192.43.244.18(time.nist.gov)

          SNTP Server IP

```

```

1)

Ruijie# config

2)      SNTP Server IP

Ruijie(config)# sntp server <ip-addr>

```

3)

Ruijie(config)# **end**

4)

Ruijie# **show running-config**

5)

Ruijie# **copy running-config startup-config**

SNTP

SNTP Client

NTP Server

NTP Server

1)

Ruijie# **config**

2)

60 -65535

1800

2

-8

8

-23

0

23

8

NTP

NTP
NTP NTP NTP

ntp authenticate	NTP
no ntp authenticate	NTP

ntp authentication-key ntp trusted-key

NTP

NTP
trusted-key key-id **ntp**

NTP

ntp server *ip-addr* [**version**
version][**source** *if-name*
number][**key** *keyid*][**prefer**]

NTP

no ntp	NTP
ntp authenticate ntp server <i>ip-addr</i> [version <i>version</i>][source <i>if-name number</i>][key <i>keyid</i>][prefer]	NTP

NTP

NTP

ntp update-calendar	

NTP

ntp master [<i>stratum</i>]	NTP 15 8 1
no ntp master	NTP

12

```
Ruijie(config)# ntp master 12
```

r

' **peer**

NTP

debug ntp	
no debug ntp	

NTP

show ntp status

NTP

NTP

show ntp status	NTP

```
Ruijie# show ntp status
Clock is synchronized, stratum 9, reference is 192.168.217.100
nominal freq is 250.0000 Hz, actual freq is 250.0000 Hz,
precision is 2**18
reference time is AF3CF6AE.3BF8CB56 (20:55:10.000 UTC Mon Mar
1 1993)
clock offset is 32.97540 sec, root delay is 0.00000 sec
root dispersion is 0.00003 msec, peer dispersion is 0.00003 msec
```

```

starum          reference          freq
  precision          reference time
  UTC          clock offset          root delay          root
dispersion          peer dispersion
```

```

          master  NTP
key-id  6 key-string  woooooop
          NTP
          NTP
          NTP
```

IPv4

```
Ruijie(config)# no ntp
Ruijie(config)# ntp authentication-key 6 md5 woooooop
Ruijie(config)# ntp authenticate
```

```
Ruijie(config)# ntp trusted-key 6
Ruijie(config)# ntp server 192.168.210.222 key 6
Ruijie(config)# interface gigabitEthernet 0/1
Ruijie(config-if)# ntp disable
Ruijie(config-if)# no ntp disable
```

UDP-Helper

UDP-Helper

UDP-Helper

UDP-Helper

UDP

UDP

UDP-Helper UDP

Ruijie(config)# udp-helper enable	udp-helper enable	UDP UDP
--	--------------------------	------------

no udp-helper enable UDP

/ :

- 1)
- 2) UDP 69 53 37 137 138 49
UDP
- 3) DUP UDP

Ruijie(config-if)# ip helper-address ip-address	UDP

no ip helper-address

/ :

- 1) 20
- 2) UDP-Helper
UDP

UDP

Ruijie(config)# ip forward-protocol udp ID	UDP UDP UDP-Helper 69 53 37 137 138 49

```
no ip forward-protocol udp port                UDP
/
:
'          UDP-Helper
          UDP
'          UDP          69 53 37 137 138 49
UDP
'          256          UDP
'          ip forward-protocol udp domain ip
forward-protocol udp 53
```

SNMP

SNMP

SNMP	Simple Network Manger Protocol	1988
8	RFC1157	
SNMP		
SNMP		
	SNMP	
SNMP	/	
'	SNMP	
'	SNMP	
'	MIB	
SNMP	SNMP	NMS
(Network Management System)		HP
OpenView	NMS	

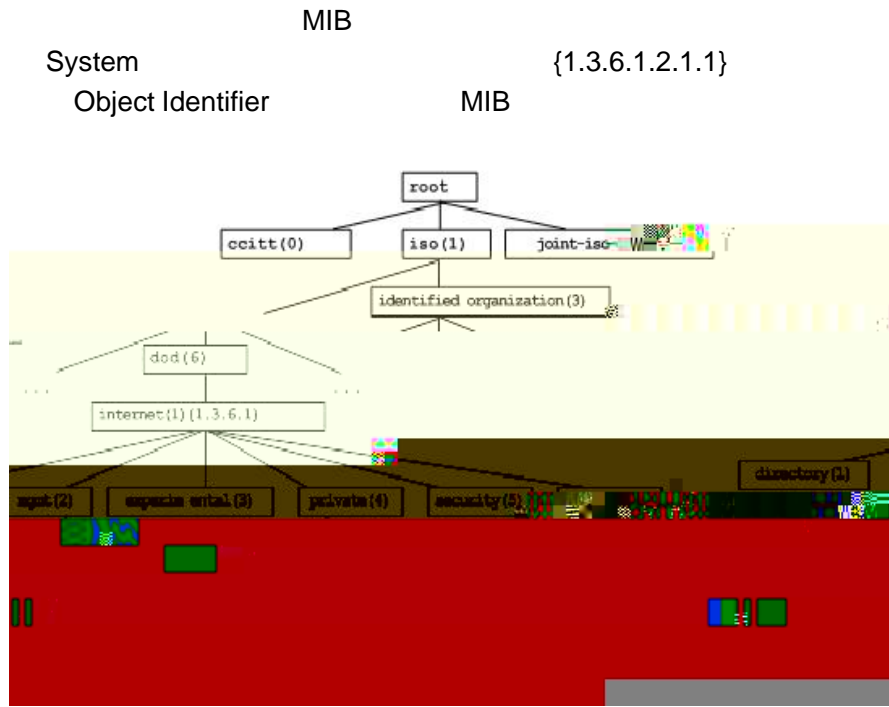

2 MIB

SNMP

SNMP			
' SNMPv1			RFC1157
' SNMPv2C	Community-Based	SNMPv2	,
RFC1901			
' SNMPv3			
1.			
2.			
3.			
SNMPv1	SNMPv2C	Community-based	MIB
		(Community String)	
SNMPv2C	Get-bulk		
	Get-bulk		
	-	SNMPv2C	
		SNMPv1	
			SNMPv1
SNMPv2C	SNMP	SNMPv1	SNMPv2C

SNMP

SNMP	NMS	Agent	6
1. Get-request	NMS	Agent	
2. Get-next-request	NMS	Agent	
3. Get-bulk	NMS	Agent	
4. Set-request	NMS	Agent	
5. Get-response	Agent	Agent	NMS
3			
6. Trap	Agent	NMS	
4	NMS	Agent	Agent
SNMPv1	Get-bulk		NMS

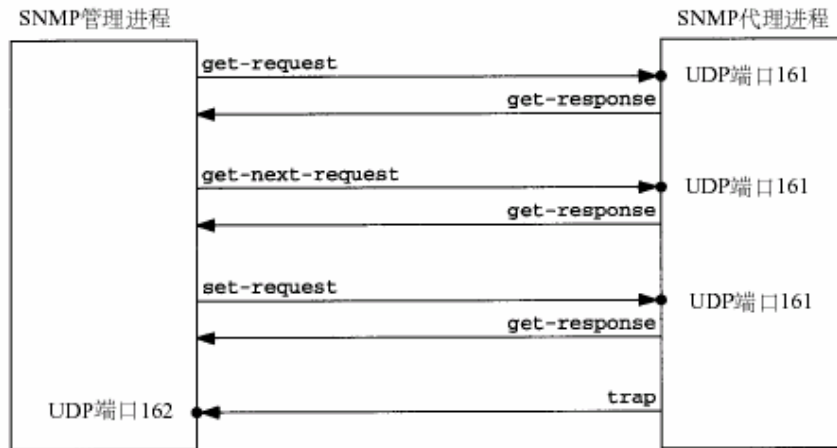

3 SNMP

NMS	Agent	3	Agent	UDP	161
Agent	Trap	UDP	162		

SNMP

SNMPv1	SNMPv2		MIB
	(NMS)		
	:		
'	(Read-only)		MIB
'	(Read-write)		MIB
SNMPv2	SNMPv		
		SNMPv1	SNMPv2C

SNMPv3

SNMPv1	noAuthNoPriv			
SNMPv2c	noAuthNoPriv			
SNMPv3	noAuthNoPriv			
SNMPv3	authNoPriv	MD5 SHA		HMAC-MD5 HMAC-SHA
SNMPv3	authPriv	MD5 SHA	DES	HMAC-MD5 HMAC-SHA CBC-DES

SNMP

		SNMP	SNMP	SNMP
SNMPv3			SNMP SnmEngineID	
		OCTET STRING	5 32	RFC3411
	:			
'	4		IANA	HEX
'	5			
0				
1	4	Ipv4		
2	16	Ipv5	IANA	HEX

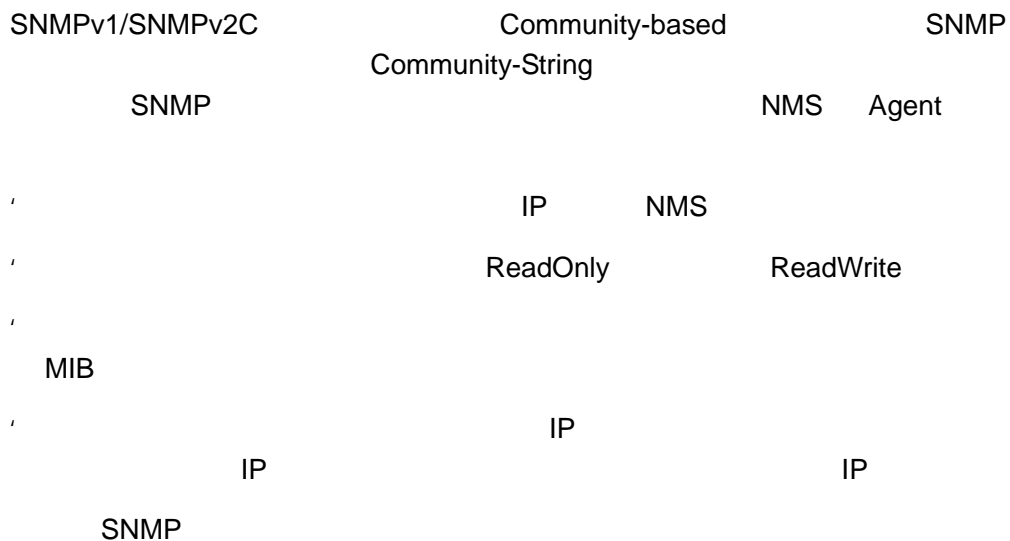

Ruijie(config)# snmp-server community <i>string</i> [view <i>view-name</i>] [ro rw] [host <i>host-ip</i>] [<i>num</i>]	

NMS
no snmp-server community

MIB



Ruijie(config)# snmp-server group <i>groupname</i> {v1 v2c v3{auth noauth priv}}[read <i>readview</i>][w rite <i>writeview</i>][access{ <i>num</i> <i>name</i> }]	
---	--

no snmp-server view *view-name* **no**
snmp-server view *view-name oid-tree*
no snmp-server group *groupname*

SNMP

NMS

SNMPv3

DES

MD5 SHA

SNMP

Ruijie(config)# snmp-server user <i>username</i> <i>roupname</i> {v1 v2 v3 [encrypted] [auth { md5 sha } <i>auth-password</i>] [priv <i>des56</i> <i>priv-password</i>] } [access { <i>num</i> <i>name</i> }]	

no snmp-server user *username* *groupname*

SNMP

Agent

NMS

Agent

NMS

Ruijie(config)# snmp-server host { <i>host-addr</i> ipv6 <i>ipv6-addr</i> } [vrf <i>vrfname</i>] [traps] [version {1 2c 3[auth noauth priv]}] community-string [udp-port <i>port-num</i>] [type]	SNMP vrf SNMPv3 SNMPv3

SNMP

SNMP Agent

NMS

SNMP

Ruijie(config)# snmp-server contact <i>text</i>	
Ruijie(config)# snmp-server location <i>text</i>	
Ruijie(config)# snmp-server chassis-id <i>number</i>	

SNMP

SNMP

Ruijie(config)# **snmp-server enable**
traps [type] [option]

Agent

Trap

!r\$!Agf\$81\$IR,\$81\$Tra

Unknown community name	
Illegal operation for community name supplied	
Encoding errors	
Get-request PDUs	Get-request
Get-next PDUs	Get-next
Set-request PDUs	Set-request
Too big errors (Maximum packet size 1500)	
No such name errors	
Bad values errors	
General errors	
Get-response PDUs	Get-response
SNMP trap PDUs	SNMP trap

```
snmpInGetNexts
snmpInSetRequests
snmpInGetResponses
snmpInTraps
snmpOutTooBig
snmpOutNoSuchNames
snmpOutBadValues
snmpOutGenErrs
snmpOutGetRequests
snmpOutGetNexts
snmpOutSetRequests
snmpOutGetResponses
snmpOutTraps
snmpEnableAuthenTraps
snmpSilentDrops
snmpProxyDrops
entPhysicalEntry
entPhysicalEntry.entPhysicalIndex
entPhysicalEntry.entPhysicalDescr
entPhysicalEntry.entPhysicalVendorType
entPhysicalEntry.entPhysicalContainedIn
entPhysicalEntry.entPhysicalClass
entPhysicalEntry.entPhysicalParentRelPos
entPhysicalEntry.entPhysicalName
entPhysicalEntry.entPhysicalHardwareRev
entPhysicalEntry.entPhysicalFirmwareRev
entPhysicalEntry.entPhysicalSoftwareRev
entPhysicalEntry.entPhysicalSerialNum
entPhysicalEntry.entPhysicalMfgName
entPhysicalEntry.entPhysicalModelName
entPhysicalEntry.entPhysicalAlias
entPhysicalEntry.entPhysicalAssetID
entPhysicalEntry.entPhysicalIsFRU
entPhysicalContainsEntry
entPhysicalContainsEntry.entPhysicalChildIndex
entLastChangeTime
```

SNMP

show snmp user

SNMP

```
Ruijie# show snmp user

User name: test
Engine ID: 8000131103000000000000
storage-type: permanent    active
```

Security level: auth priv
Auth protocol: SHA
Priv protocol: DES
Group-name: g1

SNMP

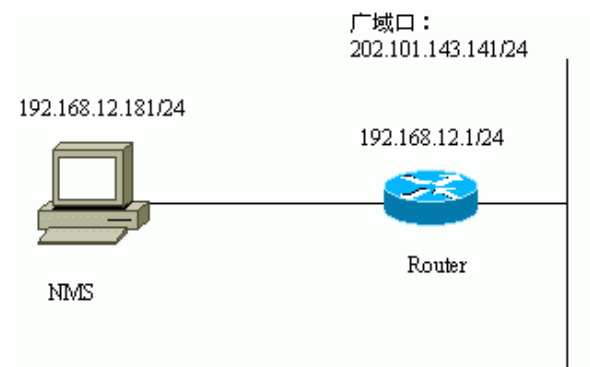

5 SNMP

SNMP

```
Ruijie(config)# snmp-server community public RO
```

NMS

SNMP

SNMP

```
Ruijie(config)# snmp-server community private RW
```

SNMP

NMS

```
Ruijie(config)# snmp-server location fuzhou
```

```
Ruijie(config)# snmp-server contact wugb@i-net.com.cn
```

```
Ruijie(config)# snmp-server chassis-id 1234567890
```

```
0987654321
```

NMS

Trap

```
Ruijie(config)# snmp-server enable traps
```

```
Ruijie(config)# snmp-server host 192.168.12.181 public
```

SNMP

NMS

HP OpenView

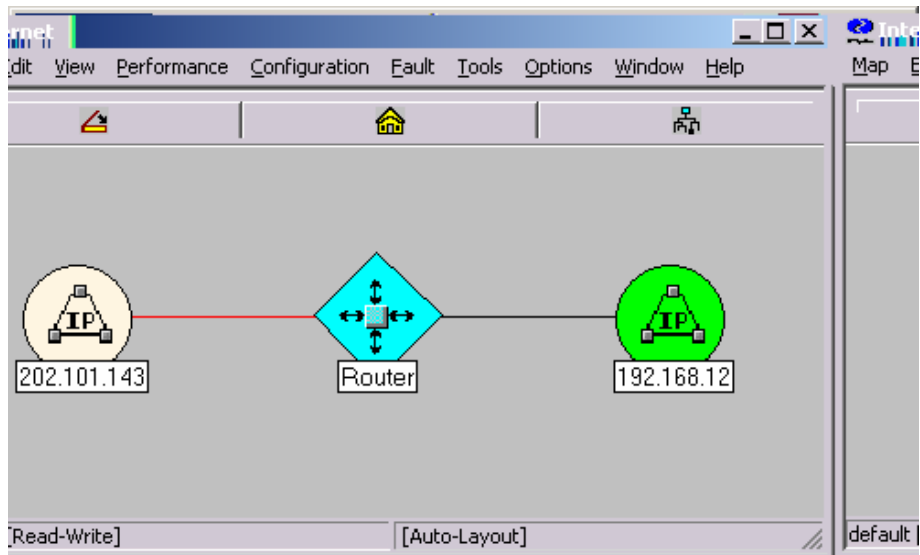

6

HP OpenView
 Name IP
 192.168.12.1 Community Name Public MIB
 System Start Query MIB
 MIB Values

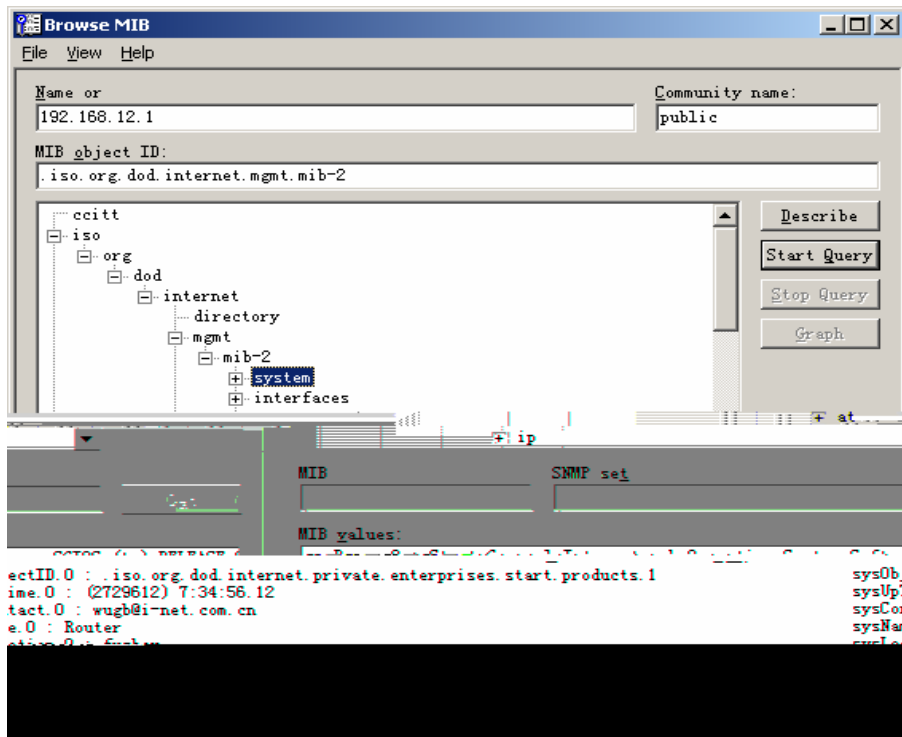

7 MIB

HP OpenView

SNMP

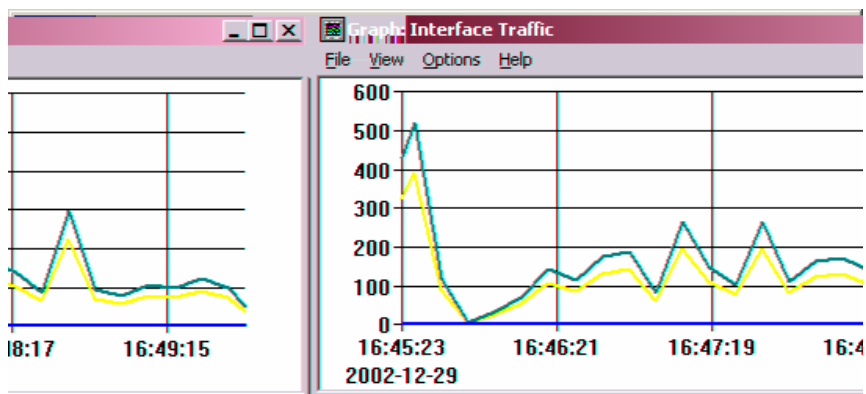

8

SNMP

```

SNMP Agent
NMS
NMS
SNMP

```

```

Ruijie(config)# access-list 1 permit 192.168.12.181
Ruijie(config)# snmp-server community public RO 1

```

```

IP 192.168.12.181 SNMP

```

SNMPv3

```

SNMPv3 v3user
MIB-2(1.3.6.1.2.1) MD5
MD5-Auth DES DES-Priv
192.168.65.199 SNMPv3 Trap Trap v3user,
MD5 MD5-Auth
DES DES-Priv

```

```

Ruijie(config)# snmp-server view v3userview 1.3.6.1.2.1
include
Ruijie (config)# snmp-server group v3usergroup v3 priv read
v3userview write v3userview
Ruijie (config)# snmp-server user v3user v3usergroup v3 auth
md5 md5-auth priv des56 des-priv
Ruijie (config)# snmp-server host 192.168.65.199 traps version
3 priv v3user

```

RMON

RMON Remote Monitoring
Internet)

IETF(Internet Engineering Task Force

RMON

RMON

RMON

RMON2

RMON

RMON

RMON1

1 2 3 9

RMON

1

CRC

(History)

RMON

2

1. HistoryControl
2. EthernetHistory

(Alarm)

RMON

3

MIB(Management Information Base

)

MIB

SNMP Trap

(Event) RMON 9
SNMP Trap

RMON



Ruijie(config-if)# **rmon collection stats** *index*

```

Bucket-number
                                Bucket-number
                                Bucket-number
1-65535          10
Interval                    1800          1-3600
    
```

Ruijie(config)# rmon alarm <i>number variable interval</i> { absolute delta } rising-threshold <i>value</i> [<i>event-number</i>] falling-threshold <i>value</i> [<i>event-number</i>] [owner <i>ownername</i>]	
Ruijie(config)# rmon event <i>number</i> [log] [trap <i>community</i>] [description <i>description-string</i>]	
Ruijie(config)# no rmon alarm <i>number</i>	
Ruijie(config)# no rmon event <i>number</i>	

```

number          ( )          1-65535
variable
interval          <1-4294967295>
                Absolute          Delta
value
event-number          Event-number
                Log
                Trap          Trap
community          Trap
description-string
    
```

RMON

Ruijie(config)# show rmon alarm	
Ruijie(config)# show rmon event	
Ruijie(config)# show rmon history	
Ruijie(config)# show rmon statistics	

RMON

rmon

show rmon alarm

```
Ruijie# show rmon alarm
Alarm : 1
Interval : 1
Variable : 1.3.6.1.2.1.4.2.0
Sample type : absolute
Last value : 64
Startup alarm : 3
Rising threshold : 10
Falling threshold : 22
Rising event : 0
Falling event : 0
Owner : zhangsan
```

show rmon event

```
Ruijie# show rmon event
Event : 1
Description : firstevent
Event type : log-and-trap
Community : public
Last time sent : 0d:0h:0m:0s
Owner : zhangsan
Log : 1
Log time : 0d:0h:37m:47s
Log description : ipttl
Log : 2
Log time : 0d:0h:38m:56s
Log description : ipttl
```

show rmon history

```
Ruijie# show rmon history
Entry : 1
Data source : Gil/1
Buckets requested : 65535
Buckets granted : 10
Interval : 1
Owner : zhangsan
Sample : 198
```

Interval start : 0d:0h:15m:0s
DropEvents : 0
Octets : 67988
Pkts : 726
BroadcastPkts : 502
MulticastPkts : 189
CRCAlignErrors : 0
UndersizePkts : 0
OversizePkts : 0
Fragments : 0
Jabbers : 0
Collisions : 0
Utilization : 0

show rmon statistics

```
Ruijie# show rmon statistics
Statistics : 1
Data source : Gil/1
DropEvents : 0
Octets : 1884085
Pkts : 3096
BroadcastPkts : 161
MulticastPkts : 97
CRCAlignErrors : 0
UndersizePkts : 0
OversizePkts : 1200
Fragments : 0
Jabbers : 0
Collisions : 0
Pkts64Octets : 128
Pkts65to127Octets : 336
Pkts128to255Octets : 229
Pkts256to511Octets : 3
Pkts512to1023Octets : 0
Pkts1024to1518Octets : 1200
Owner : zhangsan
```

r

S3760

show rmon statistics

VRF

VRF

VRF(Virtual Routing Forwarding)
VRF

VRF

```
' VRF  
' VRF  
' VRF
```

VRF

Ruijie(config)# ip vrf <i>vrf-name</i>	VRF
Ruijie(config)# no ip vrf <i>vrf-name</i>	VRF

vrf-name 64

VRF

RIP

RIP

RIP (Routing Information Protocol)

RIPv1	RFC 1058	RIP	RIPv2	RFC 2453	RGOS
RIP	UDP	UDP	520	RIPv1	
	RIPv2		224.0.0.9	RIP	30
		180			120
RIP				RIP	
		0		1	
		16			
RIP					

default-information originate

```
' RIP
' RIP
' RIP VRF ( )
IP " "
```

RIP

RIP

RIP

RIP

RIP

Ruijie(config)# router rip	RIP
Ruijie(config-router)# network <i>network-number</i> <i>wildcard</i>	

network-number *wildcard*

RIP

wildcard

RGOS

RIP

/

network

1 RIP

2 RIP

RIP

RIP

RIP

RIP

RIP

RIP

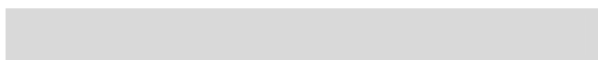

Ruijie(config-router)# version {1 2}	RIP

Ruijie(config-if)# ip rip send version 1	RIPv1
Ruijie(config-if)# ip rip send version 2	RIPv2
Ruijie(config-if)# ip rip send version 1 2	RIPv1 RIPv2

Ruijie(config-if)# ip rip receive version 1	RIPv1
Ruijie(config-if)# ip rip receive version 2	RIPv2
Ruijie(config-if)# ip rip receive version 1 2	RIPv1 RIPv2

RIP

RIPv2

RIPv1

RIPv2

RIP

RIP

RIP

Ruijie(config-router)# no auto-summary	

Ruijie(config-router)# auto-summary	
--	--

Ruijie(config-if)# ip summary-address rip <i>ip-address ip-network-mask</i>	
Ruijie(config-if)# no ip summary-address rip <i>ip-address ip-network-mask</i>	

RIP

RIPv1

RIPv2

RIPv2

MD5

ip rip authentication text-password

MD5

MD5

MD5

RIP

Ruijie(config-if)# ip rip authentication mode { text md5 }	RIP text md5 MD5
Ruijie(config-if)# ip rip authentication text-password <i>password-string</i>	1 16
Ruijie(config-if)# ip rip authentication key-chain <i>key-chain-name</i>	

RIP

RIP

RIP

RIP RIP

Ruijie(config-router)# timers basic <i>update</i> <i>invalid flush</i>	RIP

30 180 120

/

RIP

RIP

RIP RIP IP IP

IP

RIP

Ruijie(config-router)# no validate-update-source	
Ruijie(config-router)# validate-update-source	

RIP

RIP RIP RIP

RIP

RIP

Ruijie(config-router)# passive-interface { default <i>interface-type interface-num</i> }	

Ruijie(config-router)#**no passive-interface {default**

|

/

```
ip rip default-information RIP
default-information originate
```

RIP VRF

```
RIP VRF RIP RIP VRF
RIP VRF RIP VRF
address-family
(config-router-af)# RIP VRF RIP VRF
```

RouterB RouterC IP 1
RouterD

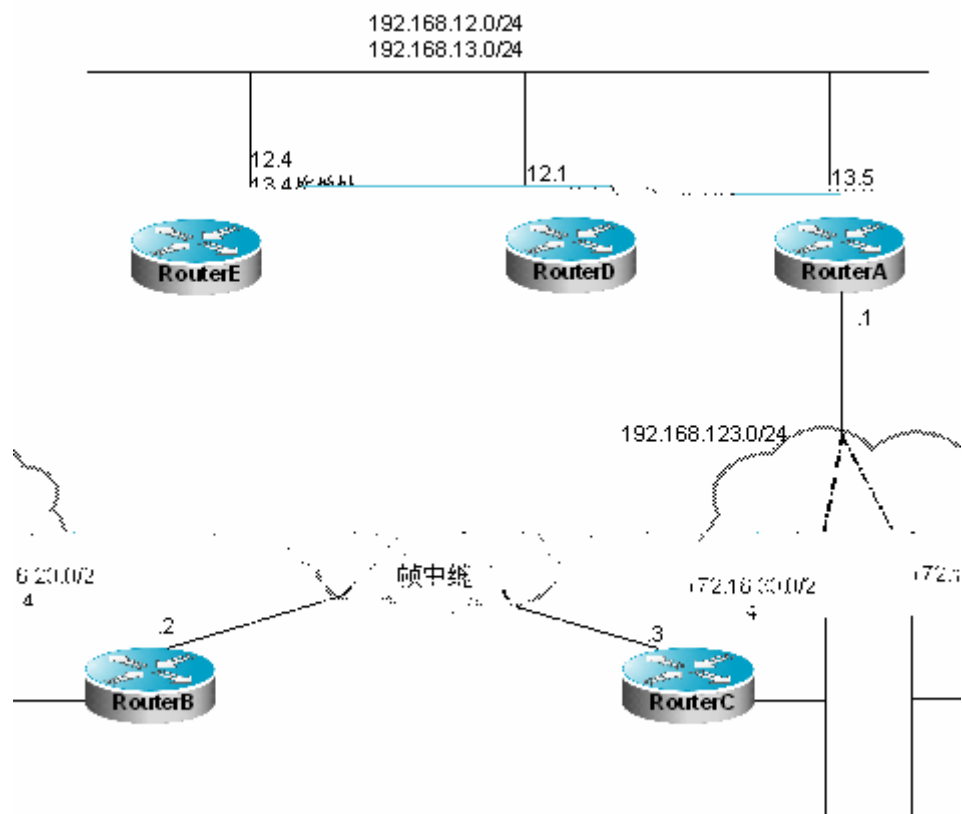

1 RIP

```

1          RIP
2 RouterB RouterC          3 RouterE
  192.168.12.0/24

          RouterA RouterD
          RouterB RouterC RouterD
          RouterE
          192.168.12.0
  
```

```

A
#
interface FastEthernet0/0
ip address 192.168.12.1 255.255.255.0
#
interface Serial1/0
ip address 192.168.123.1 255.255.255.0
encapsulation frame-relay
  
```

```
no ip split-horizon

#    RIP
router rip
version 2
network 192.168.12.0
network 192.168.123.0

    B

#
interface FastEthernet0/0
ip address 172.16.20.1 255.255.255.0

#
interface Serial1/0
ip address 192.168.123.2 255.255.255.0
encapsulation frame-relay

#    RIP
router rip
version 2
network 172.16.0.0
network 192.168.123.0
no auto-summary

    C

#
interface FastEthernet0/0
ip address 172.16.30.1 255.255.255.0

#
interface Serial1/0
ip address 192.168.123.3 255.255.255.0
encapsulation frame-relay

#    RIP
router rip
version 2
network 172.16.0.0
network 192.168.123.0
no auto-summary

    D

#
interface FastEthernet0/0
ip address 192.168.12.4 255.255.255.0
ip address 192.168.13.4 255.255.255.0 secondary
no ip split-horizon
```

```

#    RIP
router rip
version 2
network 192.168.12.0
network 192.168.13.0

    E

#
interface FastEthernet0/0
ip address 192.168.13.5 255.255.255.0

#    RIP
router rip
version 2
network 192.168.13.0
    
```

RIP

RIP MD5

IP 2

.1 RouterA 192.168.12.0/24 RouterB .3

2 RIP

Router A	RIP	Keya	Keya Keyb
RIP Router B	RIP	Keyb	Keya
Keyb RIP			

A

```

#
key chain ripkey
key 1
key-string keya
    
```

```
accept-lifetime 00:00:00 Dec 3 2000 infinite
send-lifetime 00:00:00 Dec 4 2000 infinite
key 2
key-string keyb
accept-lifetime 00:00:00 Dec 3 2000 infinite
send-lifetime 00:00:00 Dec 4 2000 infinite

#
interface FastEthernet0/0
ip address 192.168.12.1 255.255.255.0
ip rip authentication mode md5
ip rip authentication key-chain ripkey

#    RIP
router rip
version 2
network 192.168.12.0

    B    :

#
key chain ripkey
key 1
key-string keyb
accept-lifetime 00:00:00 Dec 3 2000 infinite
send-lifetime 00:00:00 Dec 4 2000 00:00:00 Dec 5 2000
key 2
key-string keya
accept-lifetime 00:00:00 Dec 3 2000 infinite
send-lifetime 00:00:00 Dec 4 2000 infinite

#
interface FastEthernet0/0
ip address 192.168.12.2 255.255.255.0
ip rip authentication mode md5
ip rip authentication key-chain ripkey

#    RIP
router rip
version 2
network 192.168.12.0
```

RIP

RIP

A

```
# VRF
ip vrf redvpn

# VRF
interface FastEthernet 1/0
ip vrf forwarding redvpn
ip address 192.168.12.1 255.255.255.0

# RIP RIP
router rip
address-family ipv4 vrf redvpn
network 192.168.12.0
exit-address-family
```

B :

```
# VRF
ip vrf bluevpn

# VRF
interface FastEthernet 1/0
ip vrf forwarding bluevpn
ip address 192.168.12.3 255.255.255.0

# RIP RIP
router rip
address-family ipv4 vrf bluevpn
network 192.168.12.0
exit-address-family
```

OSPF

OSPF

OSPF Open Shortest Path First IETF OSPF
OSPF IP
89 OSPF 224.0.0.5 IP
224.0.0.6 OSPF

RIP OSPF
RIP OSPF
VLSMs() RIPv2
1 2 RIP
RIP IGP 16 OSPF

OSPF

,

,

,

Dijkstra

IP

OSPF

OSPF

Dijkstra

OSPF

OSPF

IGP

IGP

BGP

OSPF
AREA

OSPF

OSPF

1)

- 2) ABR Area Border Routers ,
- 3) ASBR Autonomous System Boundary Routers ,
OSPF
- OSPF RFC 2328 OSPF v2
- OSPF
- 1) OSPF 64 OSPF
- 2) VRF VRF OSPF
- 3) —
- 4) — RIP BGP
- 5) — MD5
- 6) —
- 7) VLSMs
- 8)
- 9) NSSA Not So Stubby Area RFC 3101
- 10) Graceful Restart RFC 3623

OSPF

OSPF

OSPF

OSPF
OSPF

Ruijie (config-router)# network <i>address wildcard-mask area</i> <i>area-id</i>	
Ruijie (config-router)# end	
Ruijie # show ip protocols	
Ruijie # write	

/

```

vrf vrf-name          OSPF  vrf  OSPF
VRF                   OSPF  VRF  Network  32
    
```

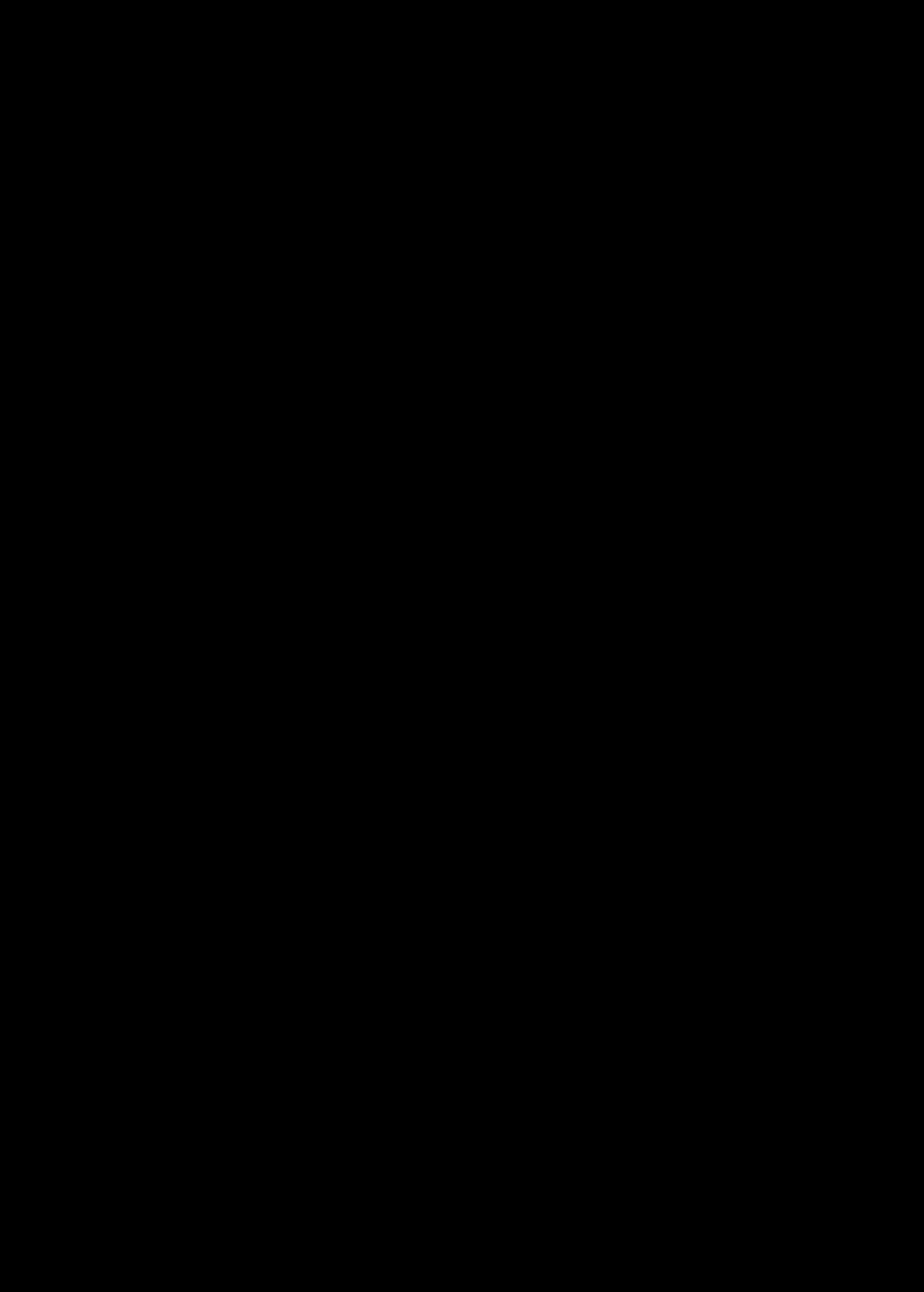

Designated Router

NBMA

2.

OSPF
OSPF

Ruijie(config-if)# ip ospf network point-to-multipoint	
Ruijie(config-if)# exit	
Ruijie(config)# router ospf 1	
Ruijie(config-router)# neighbor ip-address cost cost	

/

OSPF

X.25

ospf

NBMA

ospf

ospf

ip ospf cost

OSPF

OSPF

OSPF

“ OSPF ”

OSPF NSSA

NSSA(Not-So-Stubby Area) OSPF STUB ,NSSA
 5 LSA(AS-external-LSA) NSSA ,
 STUB NSSA OSPF

NSSA 7 NSSA ,
 7 LSA NSSA 5 LSA

NSSA

NSSA NSSA

NSSA NSSA area

nssa NSSA

NSSA

Ruijie (config-router)# area <i>area-id</i> nssa [no-redistribution] [no-summary] [default-information-originate[metric <i>metric</i>][metric-type [1 2]]]	NSSA

Ruijie (config-router)# **area**]]

no-summary ABR NSSA summary LSAs Type-3
 LSA
 area default-cost NSSA ABR
 NSSA NSSA
 1

OSPF

(Area Border Routers)

OSPF

Ruijie (config-router)# area area-id range <i>ip-address mask</i> [advertise not-advertise] [cost cost]	

/

OSPF
OSPF

Ruijie (config-router)# summary-address <i>ip-address mask</i> { not-advertise tag tag-id }	not-advertise tag tag-id

ABR ASBR discard

discard

Ruijie (config-router)# discard-route { internal external }	discard
Ruijie (config-router)# no discard-route { internal external }	discard

discard

OSPF

OSPF

,

Stub Area ABR ABR
 ABR NSSA
 ABR , router-id
 Transit Area

()

hello-interval,dead-interval

“ ” ABR OSPF
 IP ABR
 ABR type3 LSA ABR

<pre>Ruijie (config-router)# area area-id virtual-link router-id [[hello-interval seconds] [retransmit-interval seconds] [[transmit-delay seconds]][[dead-interval seconds] [authentication [message-digest null] [[authentication-key key message-digest-key keyid md5 key]]]</pre>	
--	--

/

```
router-id OSPF router-id show ip ospf
show ip ospf neighbor router-id
router-id " Loopback "
```

(ASBR)

OSPF
ASBR ASBR

ASBR

<pre>Ruijie (config-router)# default-information originate [always] [metric metric-value] [metric-type type-value] [route-map map-name]</pre>	

/

Loopback

OSPF

IP

IP ,OSPF

Loopback Loopback Loopback IP

Loopback

Loopback

Ruijie (config)# interface loopback 1	Loopback
Ruijie (config-if)# ip address ip-address mask	Loopback IP

/

OSPF IP

loopback OSPF

OSPF

0~255

OSPF 110

OSPF

Ruijie(config-router)# distance { <i>distance</i> ospf { intra-area <i>distance</i> inter-area <i>distance</i> external <i>distance</i> }}	OSPF

100Mbps
10

10Mbps

100/10 + 0.5

10

Ruijie # configure terminal	
Ruijie (config)# router ospf 1	OSPF OSPF
Ruijie(config-router)# auto-cost reference-bandwidth ref-bw	ref-bw
Ruijie (config-router)# end	
Ruijie # show ip protocols	
Ruijie # write	

no auto-cost no ip ospf cost

MTU

OSPF MTU MTU
MTU MTU, MTU
MTU

Ruijie (config-if)# ip ospf mtu-ignore	MTU

MTU

OSPF

passive-interface

OSPF

OSPF

OSPFv2 MIB



Ruijie (config-router)# enable mib-binding	OSPFv2 MIB OSPFv2

OSPFv2 TRAP

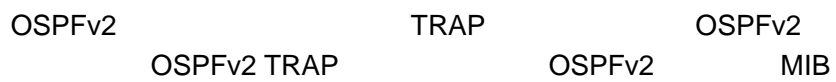

```
Ruijie (config-router)# enable traps  
[error  
[ifauthfailure | ifconfigerror |  
ifrxbadpacket | virtifauthfailure |  
virtifconfigerror |  
virtifrxbadpacket] |  
Isa [Isdbapproachoverflow |  
Isdboverflow | maxagelsa |  
originatelsa] | retransmit  
[iftxretransmit | virtiftxretransmit] |  
state-change [ifstatechange |  
nbrstatechange |  
virtifstatechange |  
virtnbrstatechange]]
```

OSPF TRAP

```
Ruijie (config)# end
```

Ruijie# **show ip ospf** [*process-id*

```
192.168.1.1
Backup Designated Router (ID) 192.168.1.2, Interface Address
192.168.1.2
Timer intervals configured, Hello 10, Dead 40, Wait 40,
Retransmit 5
Hello due in 00:00:04
Neighbor Count is 1, Adjacent neighbor count is 1
Crypt Sequence Number is 30
Hello received 972 sent 990, DD received 3 sent 4
LS-Req received 1 sent 1, LS-Upd received 10 sent 26
LS-Ack received 25 sent 7, Discarded 0
```

3 OSPF

```
Ruijie# show ip ospf
Routing Process "ospf 1" with ID 1.1.1.1
Process uptime is 4 minutes
Process bound to VRF default
Conforms to RFC2328, and RFC1583Compatibility flag is enabled
Supports only single TOS(TOS0) routes
Supports opaque LSA
This router is an ASBR (injecting external routing information)
SPF schedule delay 5 secs, Hold time between two SPFs 10 secs
LsaGroupPacing: 240 secs
Number of incoming current DD exchange neighbors 0/5
Number of outgoing current DD exchange neighbors 0/5
Number of external LSA 4. Checksum 0x0278E0
Number of opaque AS LSA 0. Checksum 0x000000
Number of non-default external LSA 4
External LSA database is unlimited.
Number of LSA originated 6
Number of LSA received 2
Log Neighbor Adjacency Changes : Enabled
Number of areas attached to this router: 1
Area 0 (BACKBONE)
Number of interfaces in this area is 1(1)
Number of fully adjacent neighbors in this area is 1
Area has no authentication
SPF algorithm last executed 00:01:26.640 ago
SPF algorithm executed 4 times
Number of LSA 3. Checksum 0x0204bf

Routing Process "ospf 20" with ID 2.2.2.2
Process uptime is 4 minutes
Process bound to VRF default
```

Conforms to RFC2328, and RFC1583Compatibility flag is enabled
Supports only single TOS(TOS0) routes
Supports opaque LSA
SPF schedule delay 5 secs, Hold time between two SPFs 10 secs
LsaGroupPacing: 240 secs
Number of incoming current DD exchange neighbors 0/5
Number of outgoing current DD exchange neighbors 0/5
Number of external LSA 0. Checksum 0x000000
Number of opaque AS LSA 0. Checksum 0x000000
Number of non-default external LSA 0
External LSA database is unlimited.
Number of LSA originated 0
Number of LSA received 0
Log Neighbor Adjacency Changes : Enabled
Number of areas attached to this router: 0

OSPF

8 OSPF

- ' OSPF NBMA
- ' OSPF
- ' OSPF
- ' OSPF
- ' OSPF ABR ASBR
- ' OSPF
- ' OSPF

OSPF NBMA

'

PVC

IP

1

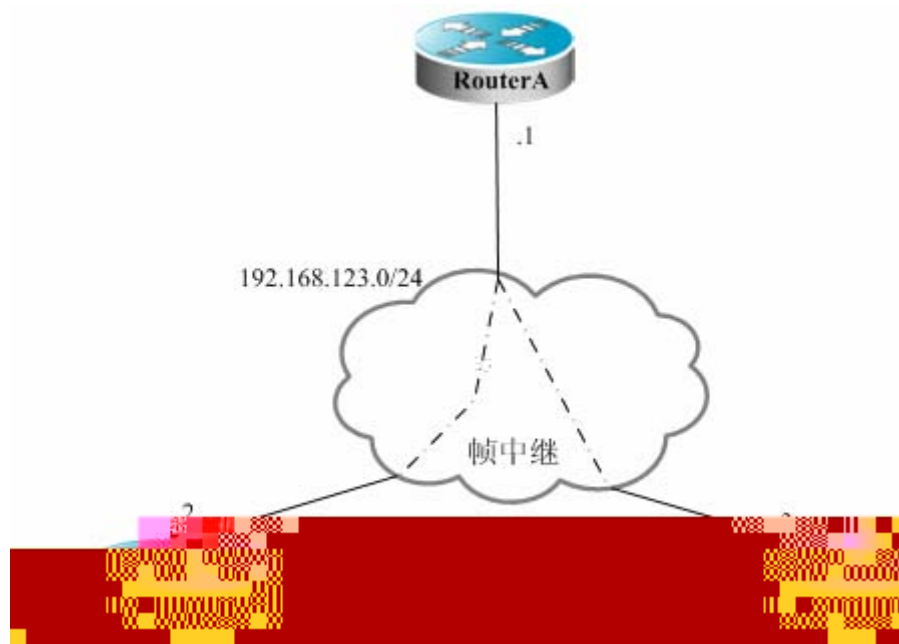

OSPF NBMA

- 1 A B C NBMA
- 2 A B
- 3
- 4

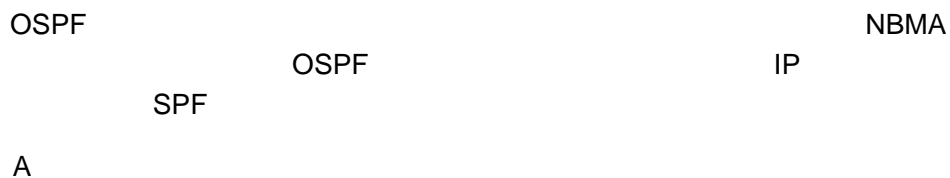

```
interface Serial 1/0
ip address 192.168.123.1 255.255.255.0
encapsulation frame-relay
ip ospf network non-broadcast
ip ospf priority 10
```

OSPF B

```
router ospf 1
network 192.168.123.0 0.0.0.255 area 0
neighbor 192.168.123.2 priority 5
neighbor 192.168.123.3
timers spf 500 1000 10000
```

B

```
interface Serial 1/0
ip address 192.168.123.2 255.255.255.0
encapsulation frame-relay
ip ospf network non-broadcast
ip ospf priority 5
```

OSPF

```
router ospf 1
network 192.168.123.0 0.0.0.255 area 0
neighbor 192.168.123.1 priority 10
neighbor 192.168.123.3
timers spf 500 1000 10000
```

C

```
interface Serial 1/0
ip address 192.168.123.3 255.255.255.0
encapsulation frame-relay
ip ospf network non-broadcast
```

OSPF

```
router ospf 1
network 192.168.123.0 0.0.0.255 area 0
neighbor 192.168.123.1 10
neighbor 192.168.123.2 5
timers spf 500 1000 10000
```

OSPF

PVC

IP

2

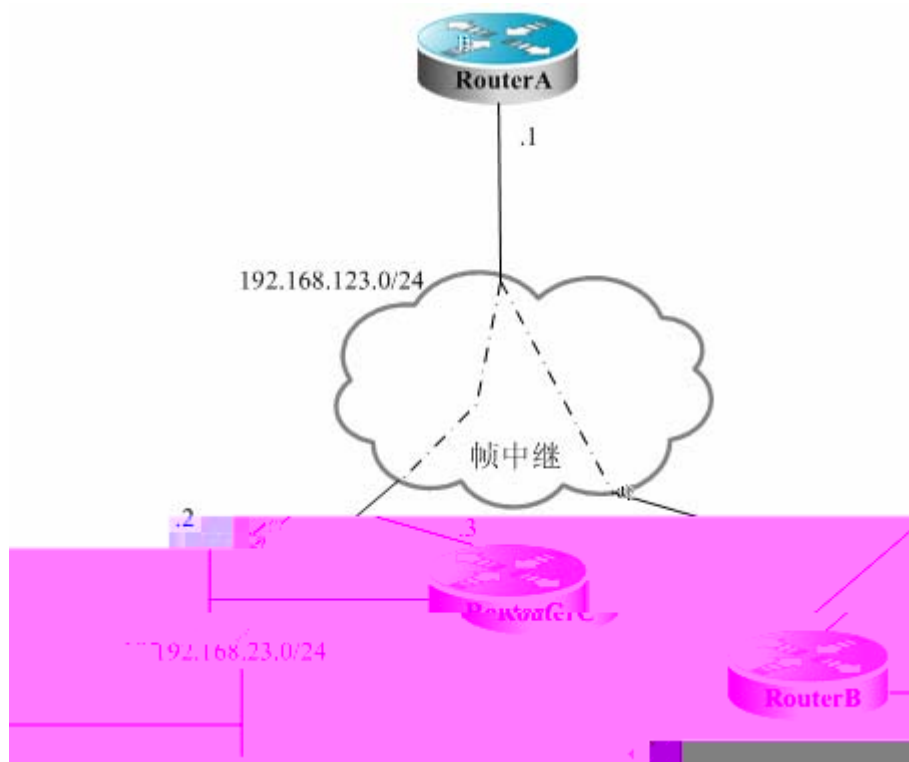

OSPF

1 A B C

OSPF

A

```
interface FastEthernet 0/0
ip address 192.168.12.1 255.255.255.0
```

```
interface Serial 1/0
ip address 192.168.123.1 255.255.255.0
encapsulation frame-relay
ip ospf network point-to-multipoint
```

OSPF

```
router ospf 1
network 192.168.23.0 0.0.0.255 area 0
network 192.168.123.0 0.0.0.255 area 0
```

B

```
interface FastEthernet 0/0  
ip address 192.168.23.2 255.255.255.0
```

```
interface Serial 1/0  
ip address 192.168.123.2 255.255.255.0  
encapsulation frame-relay  
ip ospf network point-to-multipoint
```

OSPF

```
router ospf 1  
network 192.168.23.0 0.0.0.255 area 0  
network 192.168.123.0 0.0.0.255 area 0
```

C

```
interface FastEthernet 0/0  
ip address 192.168.23.3 255.255.255.0
```

```
interface  
ip address 192.168.123.2 255.255.0  
encapsulation frame-relay  
ip ospf network point-to-multipoint
```

OSPF

```
router ospf 1  
network 192.168.23.0 0.0.0.255 area  
network 192.168.123.0 0.0.0.255 area
```

A 192.168.23.0/24

A :

```
router ospf 1  
network 192.168.123.2 cost 10  
network 192.168.123.3 cost
```

OSPF OSPF

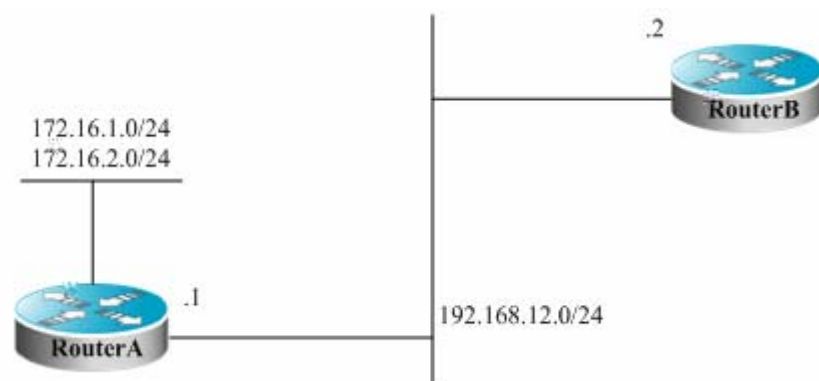
**OSPF**

OSPF

1

2

A

```
interface FastEthernet0/0
ip address 192.168.12.1 255.255.255.0
ip ospf message-digest-key 1 md5 hello
```

OSPF

```
router ospf 1
network 192.168.12.0 0.0.0.255 area 0
area 0 authentication message-digest
```

B

```
interface FastEthernet0/0
ip address 192.168.12.2 255.255.255.0
ip ospf message-digest-key 1 md5 hello
```

OSPF

```
router ospf 1
network 192.168.12.0 0.0.0.255 area 0
area 0 authentication message-digest
```

OSPF

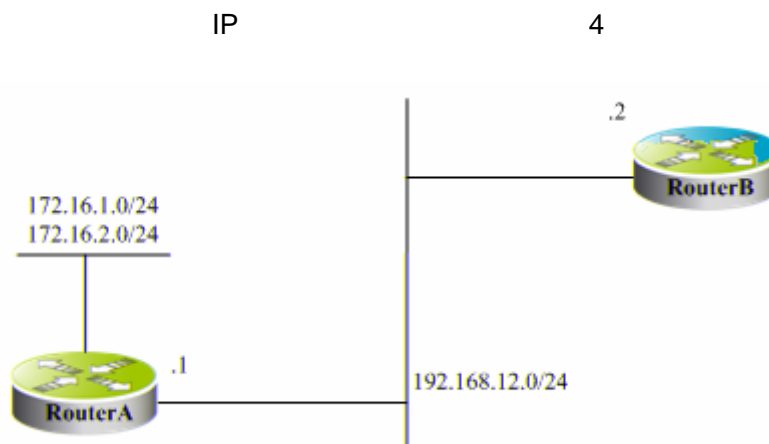

OSPF

```

1          OSPF          192.168.12.0/24      0
172.16.1.0/24 172.16.2.0/24      10

2          Router A      A          172.16.0.0/22

172.16.1.0/24 172.16.2.0/24

3          Router A      A          20
discard
    
```

Router A OSPF

A

```

interface FastEthernet0/0
ip address 192.168.12.1 255.255.255.0
    
```

2

```

interface FastEthernet1/0
ip address 172.16.1.1 255.255.255.0
interface FastEthernet1/1
ip address 172.16.2.1 255.255.255.0
    
```

OSPF

```

router ospf 1
network 192.168.12.0 0.0.0.255 area 0
    
```

OSPF

II

A

```
interface FastEthernet0/0
ip address 192.168.12.1 255.255.255.0
```

OSPF

```
router ospf 1
network 192.168.12.0 0.0.0.255 area 0
```

B

```
interface FastEthernet0/0
ip address 192.168.12.2 255.255.255.0
```

```
interface Serial 1/0
ip address 192.168.23.2 255.255.255.0
```

OSPF

```
router ospf 1
network 192.168.12.0 0.0.0.255 area 0
network 192.168.23.0 0.0.0.255 area 0
```

C

```
interface FastEthernet 0/0
ip address 192.168.34.3 255.255.255.0
```

```
interface Serial 1/0
ip address 192.168.23.3 255.255.255.0
```

OSPF

```
router ospf 1
network 192.168.23.0 0.0.0.255 area 0
network 192.168.34.0 0.0.0.255 area 34
```

D

```
interface FastEthernet 0/0
ip address 192.168.34.4 255.255.255.0
```

```
interface FastEthernet 1/0
ip address 200.200.1.1 255.255.255.0
interface FastEthernet 1/1
ip address 172.200.1.1 255.255.255.0
```

OSPF

RIP

```
router ospf 1
network 192.168.34.0 0.0.0.255 area 34
redistribute rip metric-type 1 subnets tag 34
```

RIP

```
router rip
network 200.200.1.0
network 172.200.0.0
```

B ospf

" E1"

```
O E1 200.200.1.0/24 [110/85] via 192.168.23.3, 00:00:33,
Serial1/0
O IA 192.168.34.0/24 [110/65] via 192.168.23.3, 00:00:33,
Serial1/0
O E1 172.200.1.0 [110/85] via 192.168.23.3, 00:00:33,
Serial1/0
```

OSPF

,

		OSPF	192.168.12.0/24	192.168.23.0/24
0	192.168.34.0/24		34	IP
6				

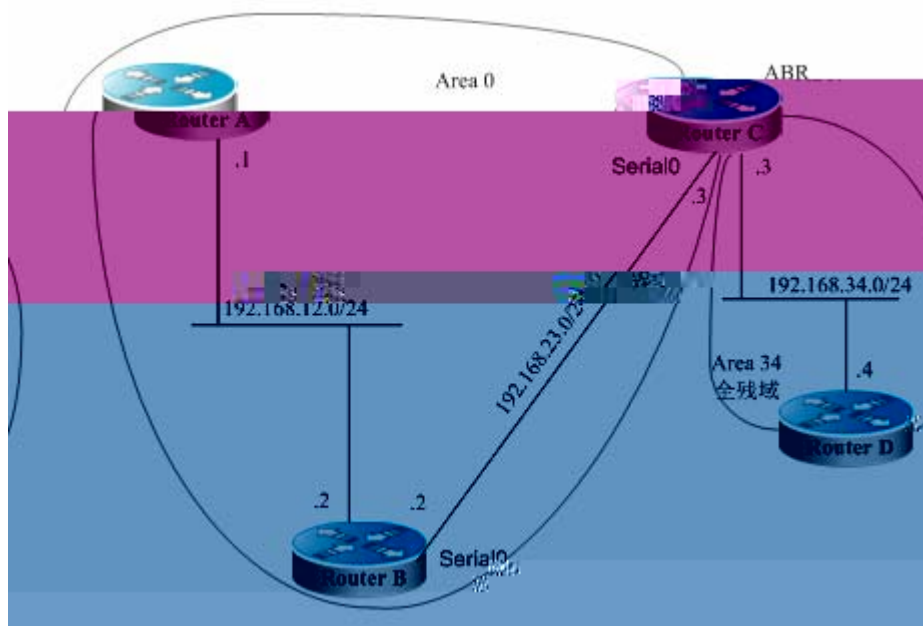

OSPF

RouterD

OSPF

C 192.168.30.0/24
A

D

```
interface FastEthernet0/0
ip address 192.168.12.1 255.255.255.0
```

OSPF

```
router ospf 1
network 192.168.12.0 0.0.0.255 area 0
```

B

```
interface FastEthernet0/0
ip address 192.168.12.2 255.255.255.0
```

```
interface Serial1/0
ip address 192.168.23.2 255.255.255.0
```

OSPF

```
router ospf 1
network 192.168.12.0 0.0.0.255 area 0
network 192.168.23.0 0.0.0.255 area 0
```

C

```
interface FastEthernet0/0
ip address 192.168.34.3 255.255.255.0
```

```
interface Serial1/0
ip address 192.168.23.3 255.255.255.0
```

```
interface Dialer10
ip address 192.168.30.1 255.255.255.0
```

OSPF

```
router ospf 1
network 192.168.23.0 0.0.0.255 area 0
network 192.168.34.0 0.0.0.255 area 34
network 192.168.30.0 0.0.0.255 area 34
area 34 stub no-summary
```

D

```
interface FastEthernet0/0
ip address 192.168.34.4 255.255.255.0
```

OSPF

```
router ospf 1
network 192.168.34.0 0.0.0.255 area 34
area 34 stub
```

D ospf

```
O 192.168.30.0/24 [110/1786] via 192.168.34.3, 00:00:03,
FastEthernet0/0
O*IA 0.0.0.0/0 [110/2] via 192.168.34.3, 00:00:03,
FastEthernet0/0
```

OSPF

```

192.168.23.0/24      OSPF      192.168.12.0/24      0
                    23        192.168.34.0/24      34      IP
                    7
    
```

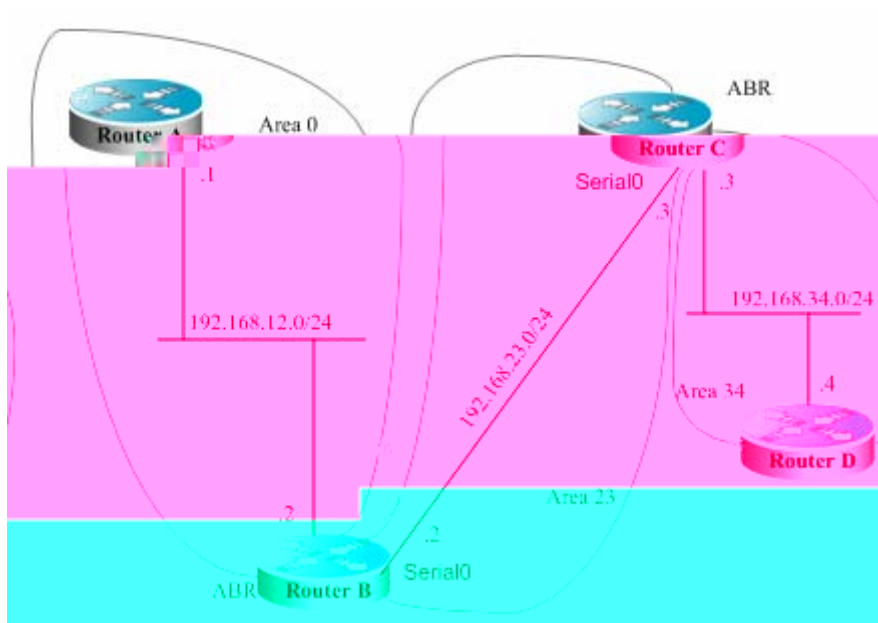

OSPF

```

D      192.168.12.0/24  192.168.23.0/24
    
```

```

OSPF      area 0
    
```

ABR

A

```

interface FastEthernet0/0
ip address 192.168.12.1 255.255.255.0
    
```

OSPF

```

router ospf 1
network 192.168.12.0 0.0.0.255 area 0
    
```

B

```

interface FastEthernet0/0
ip address 192.168.12.2 255.255.255.0
    
```

```

interface Serial11/0
    
```

```
ip address 192.168.23.2 255.255.255.0
```

IP OSPF

```
interface Loopback2  
ip address 2.2.2.2 255.255.255.0
```

OSPF

```
router ospf 1  
network 192.168.12.0 0.0.0.255 area 0  
network 192.168.23.0 0.0.0.255 area 23  
area 23 virtual-link 3.3.3.3
```

C

```
interface FastEthernet0/0  
ip address 192.168.34.3 255.255.255.0
```

```
interface Serial1/0  
ip address 192.168.23.3 255.255.255.0
```

IP OSPF

```
interface Loopback2  
ip address 3.3.3.3 255.255.255.0
```

OSPF

```
router ospf 1  
network 192.168.23.0 0.0.0.255 area 23  
network 192.168.34.0 0.0.0.255 area 34  
area 23 virtual-link 2.2.2.2
```

D

```
interface FastEthernet0/0  
ip address 192.168.34.4 255.255.255.0
```

OSPF

```
router ospf 1  
network 192.168.34.0 0.0.0.255 area 34
```

D ospf

```
O IA 192.168.12.0/24 [110/66] via 192.168.34.3, 00:00:10,  
FastEthernet0/0  
O IA 192.168.23.0/24 [110/65] via 192.168.34.3, 00:00:25,  
FastEthernet0/0
```

RIP OSPF

" down"

VRF VRF VRF VRF
VRF VRF VRF VRF
1 weight show ip route weight
weight WCMP weight
32 WCMP WCMP

WCMP

WCMP 8

```
Ruijie(config)#ip route 10.0.0.0 255.0.0.0 172.0.1.2 weight 6
Ruijie(config)#ip route 10.0.0.0 255.0.0.0 172.0.1.4 weight 6
Ruijie(config)#show ip route 10.0.0.0
```

```
Routing entry for 10.0.0.0/8
  Distance 1, metric 0
  Routing Descriptor Blocks:
    *172.0.1.2, generated by "static"
Ruijie(config)#show ip route weight
```

```
-----[distance/metric/weight]-----
S   10.0.0.0/8 [1/0/6] via 172.0.1.2
```

1000

RPI IP show ip route IP



" 2 1 "

RIP RIP " 0.0.0.0" RIP
" OSPF "



maximum-paths [<i>number</i>]	32
--	----

(route-map)

Ruijie(config)# route-map <i>route-map-name</i> [permit deny] <i>sequence</i>	<i>sequence</i> 0-65535
Ruijie(config)# no route-map <i>route-map-name</i> {[permit deny] <i>sequence</i> }	

match
match
set
match
set

Ruijie(config-route-map)# match community { <i>standard-list-number</i> <i>expanded-list-number</i> <i>community-list-name</i> }	BGP
Ruijie(config-route-map)# match interface <i>interface-type interface-number</i>	
Ruijie(config-route-map)# match ip address <i>Access-list-number</i> [... <i>access-list-number</i>]	
Ruijie(config-route-map)# match ip next-hop <i>access-list-number</i> [... <i>access-list-number</i>]	
Ruijie(config-route-map)# match ip route-source <i>access-list-number</i> [... <i>access-list-number</i>]	
Ruijie(config-route-map)# match ipv6 address { <i>access-list-name</i> prefix-list <i>prefix-list-name</i> }	IPv6

Ruijie(config-route-map)# match ipv6 next-hop { <i>access-list-name</i> prefix-list <i>prefix-list-name</i> }	
Ruijie(config-route-map)# match ipv6 route-source { <i>access-list-name</i> prefix-list <i>prefix-list-name</i> }	
Ruijie(config-route-map)# match metric <i>Metric</i>	<i>Metric</i> 0-4294967295
Ruijie(config-route-map)# match origin { egp igp incomplete }	
Ruijie(config-route-map)# match route-type { local internal external [level-1 level-2]}	
Ruijie(config-route-map)# match tag <i>tag</i>	<i>tag</i> 0-4294967295

Ruijie(config-route-map)# set aggregator as <i>as-num ip_addr</i>	AS
Ruijie(config-route-map)# set as-path prepend <i>as-number</i>	AS_PATH
Ruijie(config-route-map)# set comm-list <i>community-list-number</i> <i>community-list-name</i> delete	COMMUNITY_LIST community
Ruijie(config-route-map)# set community { <i>community-number</i> [<i>community-number</i> ...]} additive none }	COMMUNITY
Ruijie(config-route-map)# set dampening <i>half-life reuse suppress max-suppress-time</i>	
Ruijie(config-route-map)# set extcommunity { rt <i>extend-community-value</i> soo <i>extend-community-value</i> }	
Ruijie(config-route-map)# set interface <i>interface-type interface-number</i>	
Ruijie(config-route-map)# set ip default next-hop <i>ip-address</i>	IP
Ruijie(config-route-map)# set ip next-hop <i>ip-address</i>	IP

Ruijie(config-route-map)# set ip next-hop verify-availability <i>ip-address track track-object-num</i>	IP
Ruijie(config-route-map)# set level { stub-area backbone level-1 level-1-2 level-2 }	
Ruijie(config-route-map)# set local-preference <i>number</i>	LOCAL_PREFERENCE
Ruijie(config-route-map)# set metric <i>metric</i>	

OSPF

Ruijie(config-router)# default-information originate [always] [metric <i>metric</i>] [metric-type <i>type</i>] [route-map <i>map-name</i>]	always() metric() <i>metric</i> metric-type() OSPF route-map()
Ruijie(config-router)# no default-information originate [always] [metric <i>metric</i>] [metric-type <i>type</i>] [route-map <i>map-name</i>]	

:

Ruijie(config-router)# distribute-list {[<i>access-list-number</i> <i>access-list-name</i>] prefix <i>prefix-list-name</i> } out [<i>interface-type</i> <i>interface-number</i>]	prefix ip prefix-list
Ruijie(config-router)# no distribute-list {[<i>access-list-number</i> <i>access-list-name</i>] prefix <i>prefix-list-name</i> } out [<i>interface-type</i> <i>interface-number</i> <i>protocol</i>]	

/

OSPF

OSPF

OSPF

<pre>Ruijie(config-router)# distribute-list {[<i>access-list-number</i> <i>access-list-name</i>] prefix <i>prefix-list-name</i> [gateway <i>prefix-list-name</i>] gateway <i>prefix-list-name</i>} in [<i>interface-type</i> <i>interface-number</i>]</pre>	<p>prefix</p> <p>ip</p> <p>prefix-list</p> <p>gateway</p>
<pre>Ruijie(config-router)# no distribute-list {[<i>access-list-number</i> <i>name</i>] prefix <i>prefix-list-name</i> [gateway <i>prefix-list-name</i>] gateway <i>prefix-list-name</i> } in [<i>interface-type</i> <i>interface-number</i>]</pre>	

```

      OSPF      RIP      4
RIP      OSPF      type-1
40      40
#      OSPF
Ruijie(config)# router ospf 1
```

```
Ruijie(config-router)# network 192.168.12.0 0.0.0.255 area 0
```

```
#
```

```
Ruijie(config)# access-list 20 permit 200.168.23.0
```

```
#
```

```
Ruijie(config)# route-map redrip permit 10
```

```
Ruijie(config-route-map)# match metric 4
```

```
Ruijie(config-route-map)# set metric 40
```

```
Ruijie(config-route-map)# set metric-type type-1
```

```
Ruijie(config-route-map)# set tag 40
```

```
                                RIP                OSPF                10
OSPF                            10
```

```
#    RIP
```

```
Ruijie(config)# router rip
```

```
Ruijie(config-router)# version 2
```

```
Ruijie(config-router)# redistribute ospf 1 route-map redospf
```

```
Ruijie(config-router)# network 200.168.23.0
```

```
#
```

```
Ruijie(config)# route-map redospf permit 10
```

```
Ruijie(config-route-map)# match tag 10
```

```
Ruijie(config-route-map)# set metric 10
```

```
                                OSPF                RIP
```

```

RIP                                     3                                     RIP
                                     172.16.1.0/24 192.168.1.0/24
,

RIP                                     RIP                                     RIP
                                     172.16.1.0/24                                     172.16.0.0/16

#
Ruijie(config)# ip route 172.16.1.0 255.255.255.0 172.200.1.2
Ruijie(config)# ip route 192.168.1.0 255.255.255.0 172.200.1.2
Ruijie(config)# ip route 192.168.2.0 255.255.255.0 172.200.1.4

#    RIP
Ruijie(config)# router rip
Ruijie(config-router)# version 2
Ruijie(config-router)# redistribute static
Ruijie(config-router)# network 192.168.34.0
Ruijie(config-router)# distribute-list EXT_ACL out static
Ruijie(config-router)# no auto-summary

#    ACL
Ruijie(config)# ip access-list extended EXT_ACL
Ruijie(config-ext-nacl)#10 permit ip 192.168.1.0 0.0.0.255
any
Ruijie(config-ext-nacl)#10 permit ip 172.16.1.0 0.0.0.255 any

,

RIP                                     1       A       OSPF                                     C
                                     D       BGP                                     B
A       192.168.10.0/24 192.168.100.1/32                                     C
192.168.3.0/24 192.168.30.0/24                                     D       192.168.4.0/24
192.168.40.0/24

```

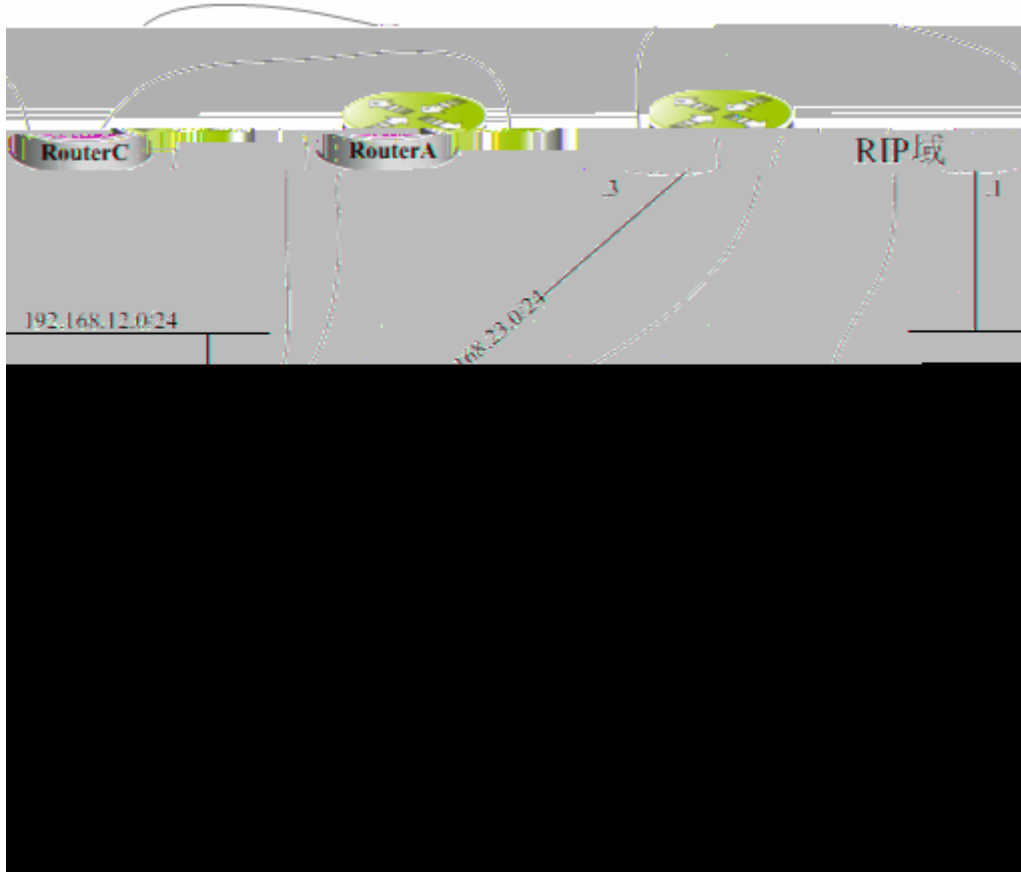

1

Router B	OSPF	RIP				Type-1
BGP		11:11	BGP	RIP		OSPF
192.168.10.0/24			3			

RIP

BGP

A

```
#
Ruijie(config)# interface gigabitEthernet 0/0
Ruijie(config-if)# ip address 192.168.10.1 255.255.255.0
Ruijie(config)# interface loopback 1
Ruijie(config-if)# ip address 192.168.100.1 255.255.255.0
Ruijie(config-if)# no ip directed-broadcast
Ruijie(config)# interface gigabitEthernet 0/1
Ruijie(config-if)# ip address 192.168.12.55 255.255.255.0
```

```
# OSPF
Ruijie(config)# router ospf 12
Ruijie(config-router)# network 192.168.10.0 0.0.0.255 area 0
Ruijie(config-router)# network 192.168.12.0 0.0.0.255 area 0
Ruijie(config-router)# network 192.168.100.0 0.0.0.255 area 0
```

B

```
#
Ruijie(config)# interface gigabitEthernet 0/0
Ruijie(config-if)# ip address 192.168.12.5 255.255.255.0
Ruijie(config)# interface Serial 1/0
Ruijie(config-if)# ip address 192.168.23.2 255.255.255.0
```

```
# OSPF
Ruijie(config)# router ospf 12
Ruijie(config-router)# redistribute rip metric 100 metric-type
1 subnets
Ruijie(config-router)# redistribute bgp route-map ospfrm
subnets http://tQ@Ee0u5A98A4k#u%RE4&Bnf0g1#Tf0jTCT2.12Tf0u6e0)#d190u168.
```

```
Ruijie(config)# interface gigabitEthernet 0/0
Ruijie(config-if)# ip address 192.168.30.1 255.255.255.0
Ruijie(config)# interface gigabitEthernet 0/1
Ruijie(config-if)# ip address 192.168.3.1 255.255.255.0
Ruijie(config)#
```

ECMP/WCMP

ECMP/WCMP

hash

hash

/

S3760
weight

*Aug 24 11:20:39: %7: Warning: Because hardware resource is not enough, route:
*Aug 24 11:20:39: %7: 191.168.200.120/32 191.168.200.120
*Aug 24 11:20:39: %7: were deleted

Hash

S3760 hash

' MAC SA [5:0]
' MAC DA [5:0]
' SIP [22:16] [6:0]
' DIP [22:16] [6:0]

S3760

Hash

S3760 hash



	ECMP/WCMP
Ruijie(config)#	src-dst-ip IP IP
aggregateport	IP—— IP
load-balance	IP—— IP
{ src-dst-mac	src-dst-mac MAC MAC
src-dst-ip }	MAC—— MAC
	MAC—— MAC

hash ip

Ruijie(config)# **aggregateport load-balance src-dst-ip**

IP

1

:

1.

Ruijie(config)# route-map <i>route-map-name</i> [permit deny] <i>sequence</i>	
Ruijie(config)# no route-map <i>route-map-name</i> {[permit deny] sequence}	

2.

Ruijie(config-route-map)# match ip address <i>access-list-number</i>	
Ruijie(config-route-map)# match length <i>min</i> <i>max</i>	

3.

Ruijie(config-route-map)# set ip default next-hop <i>ip-address[weight][ip-address[weight]]</i>	IP

Ruijie(config-route-map)# set ip next-hop <i>ip-address [weight][ip-address[weight]]</i>	IP
--	----

4.

, :

Ruijie(config-if)# ip policy route-map <i>name</i>	route-map
Ruijie(config-if)# no ip policy route-map	route-map

:

fastethernet 0/1 ,
192.168.5.5 : Td15321317060748703489F01d11p8 rB05.549.dm 2D)62204D11 131.886Tj

-
- 3. **set ip next-hop**
 - 4. **set ip default next-hop**
-

r

- 1.
 - (route-map sequence)
 - ACL
 - ACL
 - 2.
 - nextthop
 - ACL
 - ACL
 - nextthop,
 - ACL
 - 3.
 - ACL
 - ACL ,
 - ACL
 - ACL
 - ACL
 - ACE
 - 4.
 - IP
 - deny
 - ACE
 - IP
 - deny any any
 - ACE
 - ACE
 - ACL
 - deny
 - ACE
 - ACL
 - ACL
 - ACE
 - ACL
 - ACL
 - ACE
 - ACL
 - set
 - ACL
 - permit
 - ACL
 - ACE
 - deny
 - IP
 - 5.
 - ACL
 - "deny
 - IP
 - "
 - ACE
 - PBR
 - 6.
 - drop
 - nextthop
 - nextthop
 - nextthop
-

IPv6

IPv6

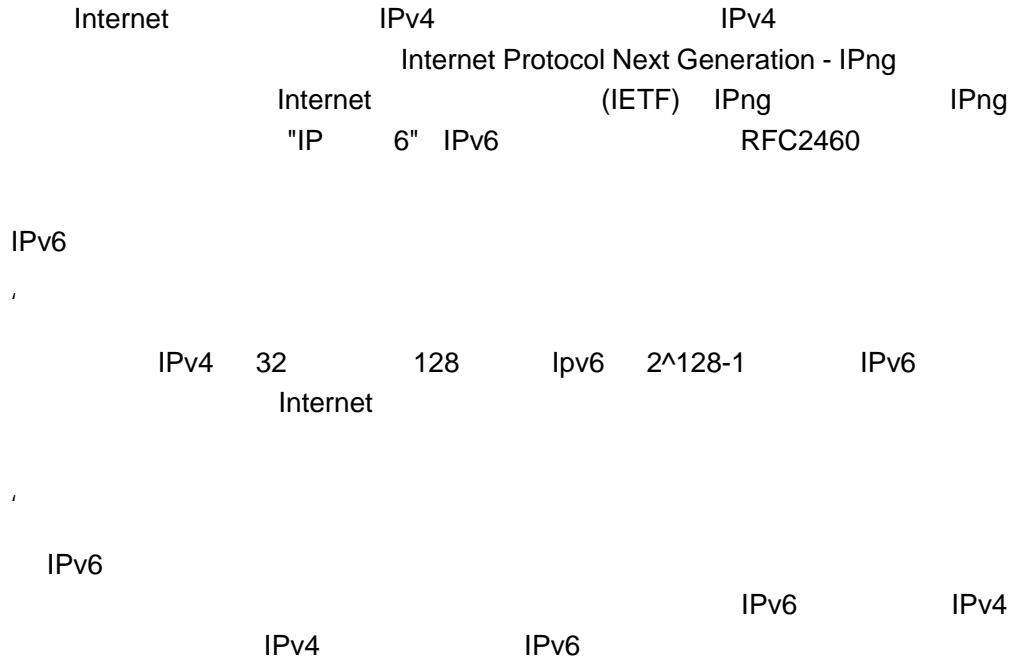

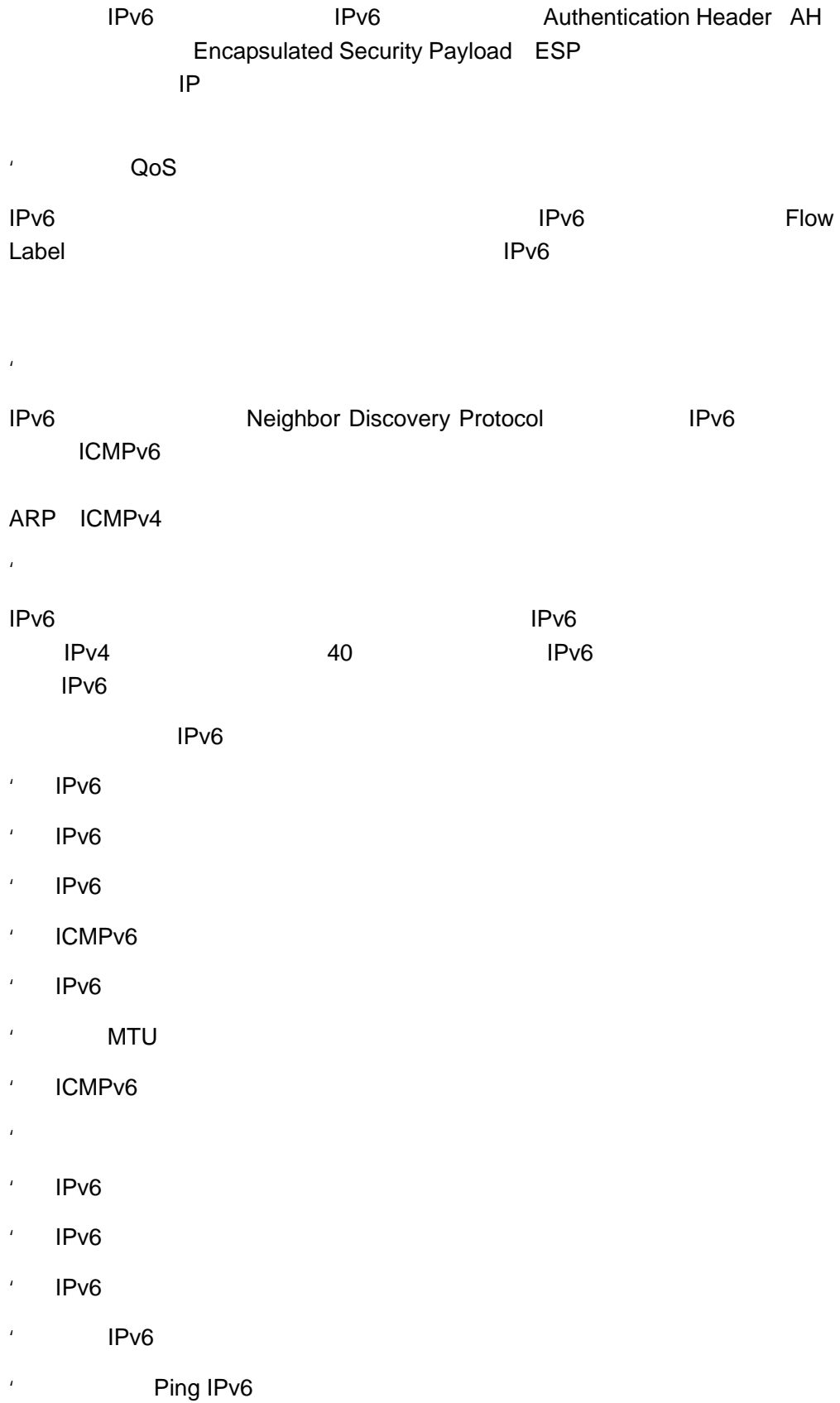

IPv6

IPv6

Unicast Addresses

IPv6

'
'
'

' IPv4 IPv6

1.

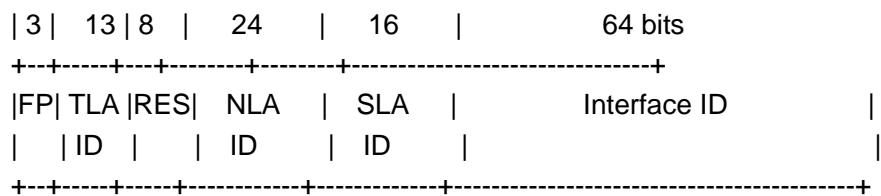

' FP (Format Prefix)

IPv6 3 IPv6
' 0 0 1'

' TLA ID (Top-Level Aggregation Identifier)

13 8192

' RES (Reserved for future use)

8

' NLA ID (Next-Level Aggregation Identifier)

24

(ISP)

24 22 (ISP) 2 4 (ISP)

' SLA ID (Site-Level Aggregation Identifier)

IPv4

16

65535 8

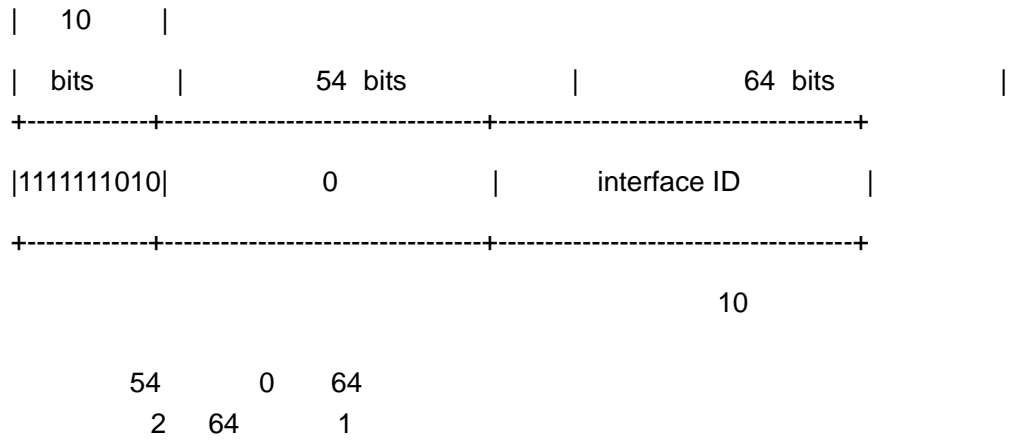
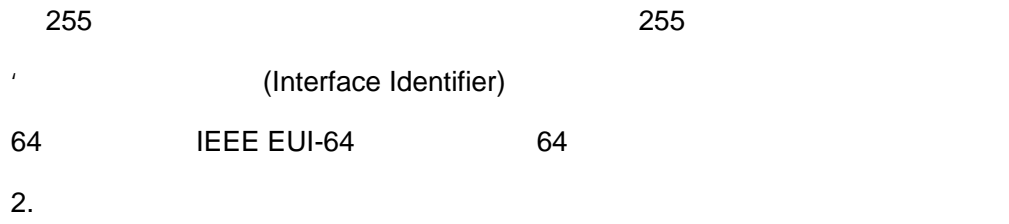

3.

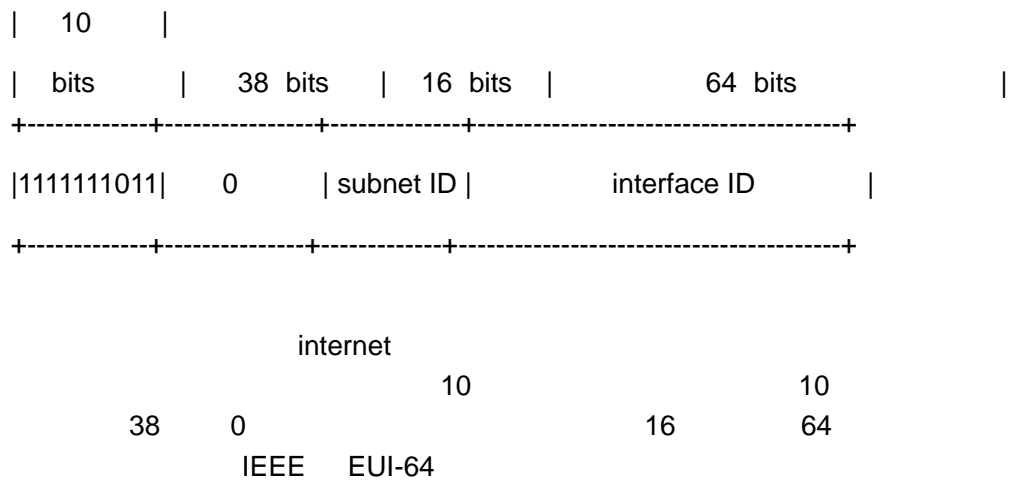

4.

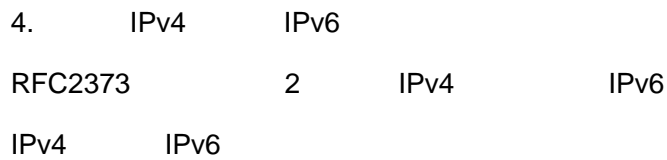

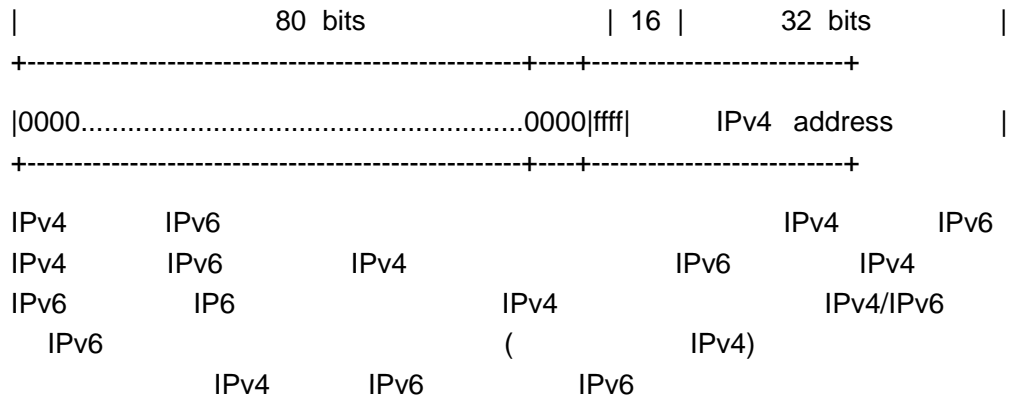

Multicast Addresses

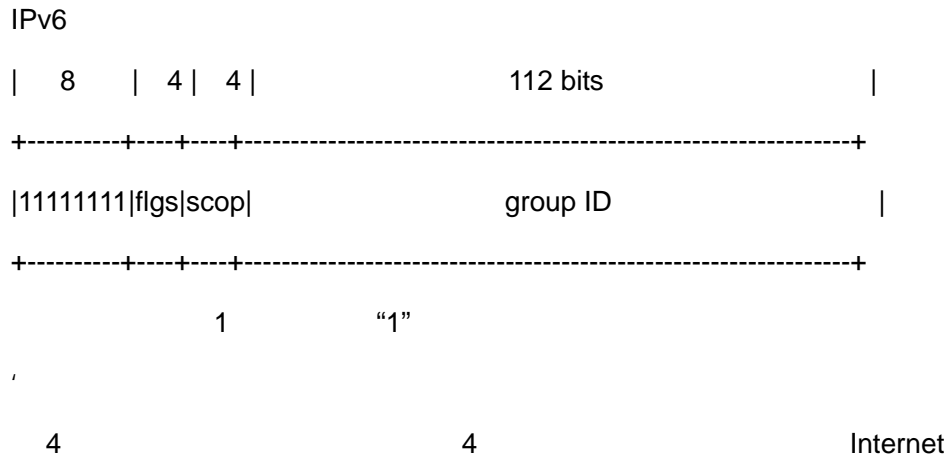

IPv6 (unicast) (anycast) IPv6
FF02:0:0:0:0:1:FF00:0000/104 24
24
FE80::2AA:FF:FE21:1234 FF02::1:FF21:1234
(NS)

IPv6单播或者泛播地址

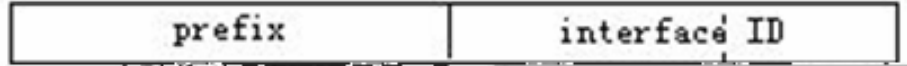

1

Anycast Addresses

IPv6



RFC2373

0(

)

()

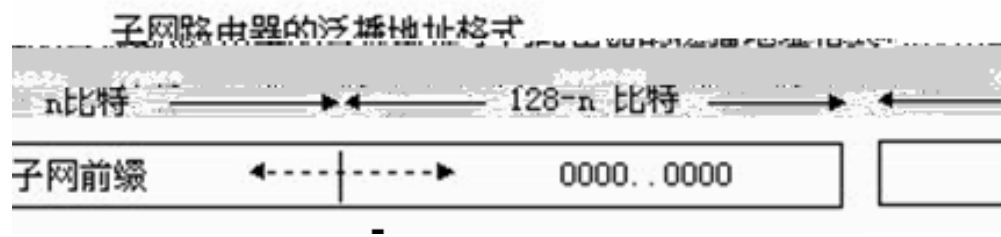

2

IPv6

IPv6



3

IPv4	4	IPv6	8
	40	IPv6	
	(Version)		
	4	IPv6	6
	(Traffic Class)		
	8	IPv4	"TOS"
	(Flow Label)		
	20		
	(Payload Length)		
	16	IPv6	IPv6
	()		

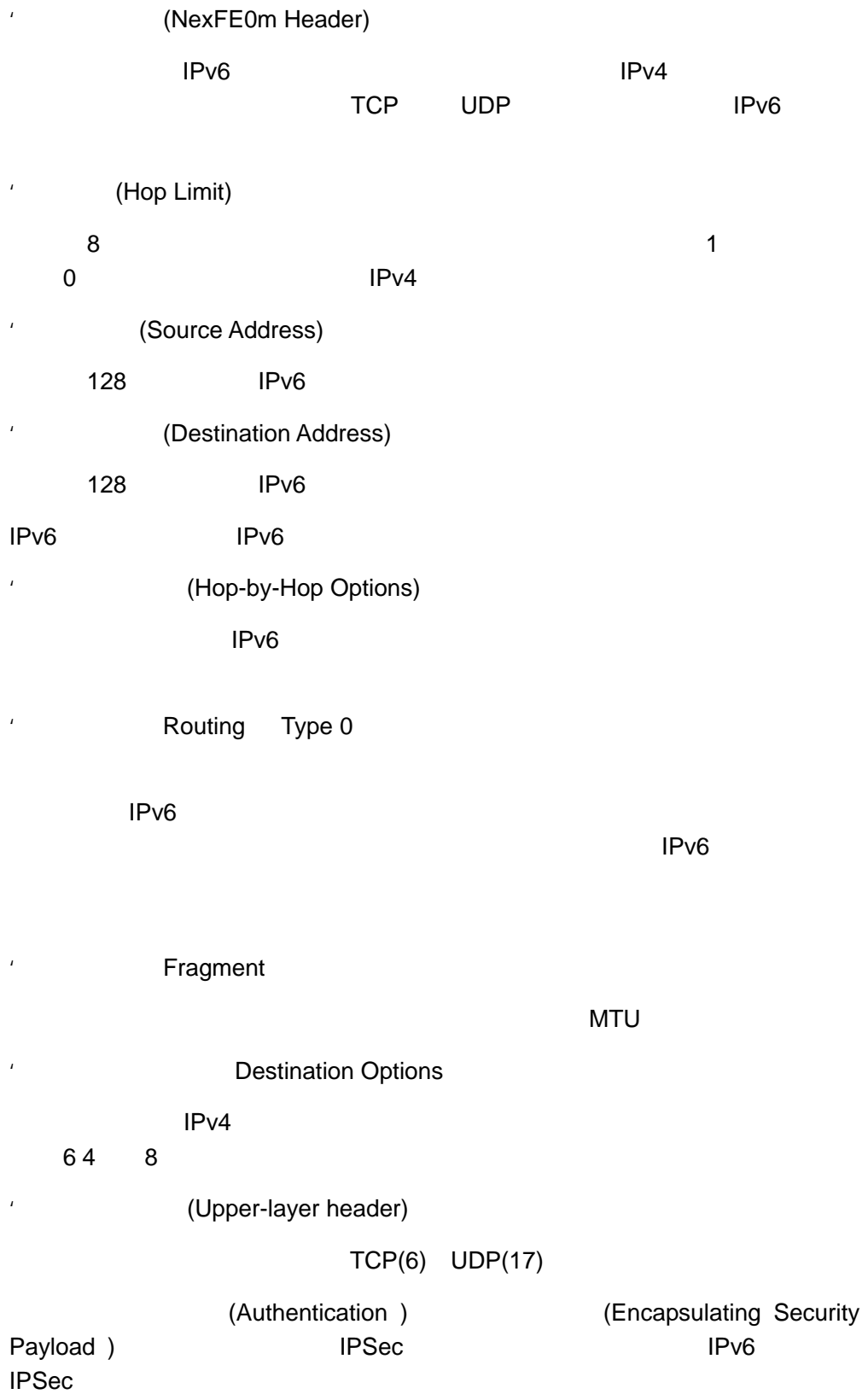

IPv6

MTU

IPv4 MTU IPv6 MTU

		MTU		IPv6		IPv6
r						
IPv4		MTU	68			
	68		MTU	IPv6	MTU	1280
IPv6			1500	MTU		

IPv6

()

Detection), NUD(Neighbor Unreachability

NUD

(::)

(Router Advertisement)

(RA)

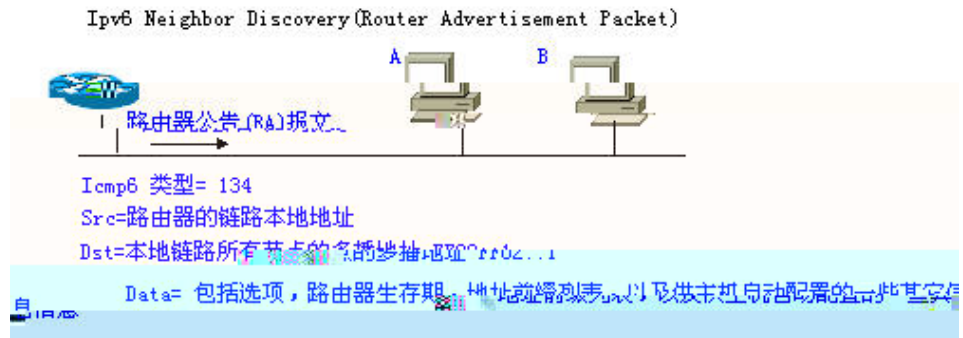

(RS) (RA)

(

FF02::1)

Ra-interval

Ra-lifetime

Prefix IPv6

Rs-interval

Reachabletime

IPv6

r

1)

2)

IPv6

no ipv6 nd suppress-ra

configure terminal			
interface <i>interface-id</i>			
ipv6 enable	IPv6	IPv6	IPv6
	IPv6	Eui-64	
	ipv6	64	
	ID		
ipv6 address		eui-64	
<i>ipv6-prefix/prefix-length</i>		(+ ID/	
[eui-64])		
	IPv6	IPv6	
		no ipv6 enable	
	IPv6		

```

Ruijie # show ipv6 interface vlan 1
Interface vlan 1 is Up, ifindex: 2001
address(es):
Mac Address: 00:d0:f8:00:00:01
INET6: fe80::2d0:f8ff:fe00:1 , subnet is fe80::/64
INET6: fec0:0:0:1::1 , subnet is fec0:0:0:1::/64
Joined group address(es):
ff01:1::1
ff02:1::1
ff02:1::2
ff02:1::1:ff00:1
MTU is 1500 bytes
ICMP error messages limited to one every 100 milliseconds
ICMP redirects are enabled
ND DAD is enabled, number of DAD attempts: 1
ND reachable time is 30000 milliseconds
ND advertised reachable time is 0 milliseconds
ND retransmit interval is 1000 milliseconds
ND advertised retransmit interval is 0 milliseconds
ND router advertisements are sent every 200 seconds<160--240>
ND router advertisements live for 1800 seconds

```

(NDP)

configure terminal	
ipv6 neighbor <i>ipv6-address</i> <i>interface-id hardware-address</i>	
end	
show ipv6 neighbors	
copy running-config startup-config	

no ipv6 neighbor

SVI 1

```
Ruijie(config)# ipv6 neighbor fec0:0:0:1::100 vlan 1
```



```

INET6: fec0:0:0:1::1 , subnet is fec0:0:0:1::/64
Joined group address(es):
ff01:1::1
ff02:1::1
ff02:1::2
ff02:1::1:ff00:1
MTU is 1500 bytes
ICMP error messages limited to one every 100 milliseconds
ICMP redirects are enabled
ND DAD is enabled, number of DAD attempts: 3
ND reachable time is 30000 milliseconds
ND advertised reachable time is 0 milliseconds
ND retransmit interval is 1000 milliseconds
ND advertised retransmit interval is 0 milliseconds
ND router advertisements are sent every 200 seconds<160--240>
ND router advertisements live for 1800 seconds

```

IPv6

2

configure terminal	
interface <i>interface-id</i>	
ipv6 enable	IPv6
ipv6 nd ns-interval <i>milliseconds</i>	
ipv6 nd reachable-time <i>milliseconds</i>	RFC4861 0.5 1.5
ipv6 nd prefix <i>ipv6-prefix/prefix-length</i> default [[<i>valid-lifetime</i> <i>preferred-lifetime</i>] [at <i>valid-date preferred-date</i>] infinite no-advertise]]	(RA)

ipv6 nd ra-lifetime <i>seconds</i>	(RA) 0
ipv6 nd ra-interval <i>seconds</i>	(RA)
ipv6 nd managed-config-flag	(RA) "managed address configuration" ,
ipv6 nd other-config-flag	"other stateful configuration" ,
ipv6 nd suppress-ra	RA
end	

```
address(es):
Mac Address: 00:d0:f8:00:00:01
INET6: fe80::2d0:f8ff:fe00:1 , subnet is fe80::/64
INET6: fec0:1:1:1::1 , subnet is fec0:1:1:1::/64
Joined group address(es):
ff01:1::1
ff02:1::1
ff02:1::2
ff02:1::1:ff00:1
MTU is 1500 bytes
ICMP error messages limited to one every 100 milliseconds
ICMP redirects are enabled
ND DAD is enabled, number of DAD attempts: 1
ND reachable time is 30000 milliseconds
ND advertised reachable time is 0 milliseconds
ND retransmit interval is 1000 milliseconds
ND advertised retransmit interval is 0 milliseconds
ND router advertisements are sent every 200 seconds<160--240>
ND router advertisements live for 1800 seconds
```

2)

```
Ruijie# show ipv6 interface ra-info
vlan 1: DOWN
RA timer is stopped
waits: 0, initcount: 3
statistics: RA(out/in/inconsistent): 4/0/0, RS(input): 0
Link-layer address: 00:00:00:00:00:01
Physical MTU: 1500
ND router advertisements live for 1800 seconds
ND router advertisements are sent every 200 seconds<160--240>
Flags: !M!O, Adv MTU: 1500
ND advertised reachable time is 0 milliseconds
ND advertised retransmit time is 0 milliseconds
ND advertised CurHopLimit is 64
Prefixes: (total: 1)
fec0:1:1:1::/64(Def, Auto, vlttime: 2592000, pltime: 604800,
flags: LA)
```

3) IPv6

```
Ruijie# show ipv6 neighbors
IPv6 Address                Linklayer Addr  Interface
fe80::200:ff:fe00:1         0000.0000.0001 vlan 1
State: REACH/H Age: - asked: 0
fec0:1:1:1::1              0000.0000.0001 vlan 1
State: REACH/H Age: - asked: 0
```

IPv6

IPv6 IPv4 IPv4 IPv6
 IPv6 IPv4 IPv6
 IPv4 IPv6 IPv4

1) IPv6

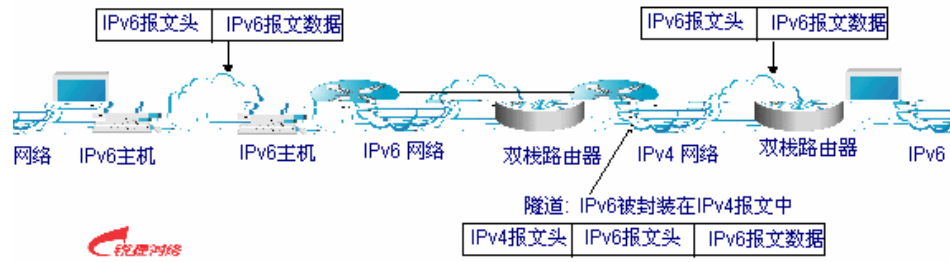

1

(IPv6 Manually Configured Tunnel)

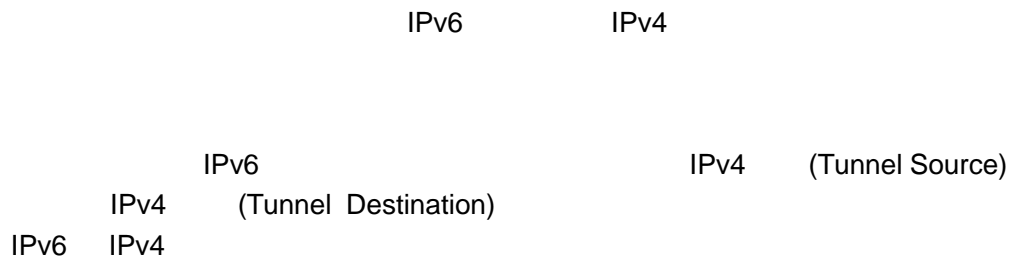

6to4 (Automatic 6to4 Tunnel)

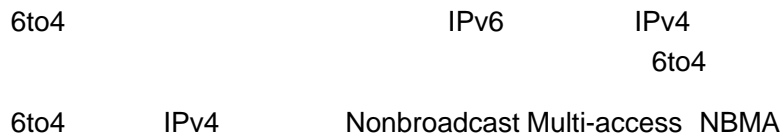

6to4	IPv4	211.1.1.1
D301:0101	1	2e0:ddff:fee0:e0e1
6to4		

2002: D301:0101:1: 2e0:ddff:fee0:e0e1

r

6to4	IPv4	IPv4	10.0.0.0/8	172.16.0.0/12
192.168.0.0/16		IPv4		

6to4

,

6to4	IPv6	IPv4	Internet
	IPv4	IPv4	

IPv4	6to4	6to4/48	IPv6	2002:IPV4
/48				

,

	IPv6	6to4	6to4
6to4	IPv6		

(6to4 Relay Router)

ISATAP (ISATAP Tunnel)

	(ISATAP)	IPv6	IPv4	IPv6
	NBMA	IPv6	IPv4	IPv6

ISATAP	IPv6	IPv6
ISATAP	ISATAP	IPv4/IPv6
ISATAP	ISATAP	ISATAP
ISATAP	IPv6	ISATAP

ISATAP	IPv6	IPv6	64
		IPv4	IPv6
32			

ISATAP	6to4
	IPv6

,

ISATAP

```
tunnel source {ip-address | type num}
exit
ipv6 route 2002::/16 tunnel tunnel-number
end
```

configure terminal	
interface tunnel <i>tunnel-num</i>	
tunnel mode ipv6ip 6to4	6to4
ipv6 enable	IPv6 IPv6 IPv6
tunnel source <i>{ip-address type num}</i>	IPv4 IPv4
Exit	
ipv6 route 2002::/16 tunnel tunnel-number	IPv6 6to4 2002::/16 (2)
End	
copy running-config startup-config	

" IPv6 "

ISATAP

```
ISATAP
ISATAP IPv6 IPv6
ISATAP EUI-64
IPv6 32 (Tunnel Source)
IPv4 ) ISATAP
```

r

ISATAP ISATAP tunnel source

ISATAP

ISATAP

```
config terminal
interface tunnel tunnel-num
tunnel mode ipv6ip isatap
ipv6 address ipv6-prefix/prefix-length eui-64
tunnel source interface-type num
no ipv6 nd suppress-ra
end
```

```

show ipv6 interface tunnel number
ping protocol destination
show ip route
show ipv6 route

```

enable	
show interface tunnel <i>tunnel-num</i>	tunnel .
show ipv6 interface tunnel <i>tunnel-num</i>	tunnel IPv6
ping <i>protocol destination</i>	
show ip route	IPv4
show ipv6 route	IPv6

1. Tunnel

```

Ruijie# show interface tunnel 1
Tunnel 1 is up, line protocol is Up
Hardware is Tunnel, Encapsulation TUNNEL
Tunnel source 192.168.5.215 , destination 192.168.5.204
Tunnel protocol/transport IPv6/IP
Tunnel TTL is 9
Tunnel source do conformance check set
Tunnel source do ingr83Tin,lter set
Tunnel destination do safety check not set
Tunnel disable receive packet not set

```

2. Tunnel IPv6

```

Ruijie# show ipv6 interface tunnel 1
interface Tunnel 1 is Up, ifindex: 6354
addr83T(es):
Mac Addr83T: N/A
INET6: fe80::3d9a:1601 , subnet is fe80::/64
Joined group addr83T(es):
ff02::2
ff01::1
ff02::1
ff02::1:ff9a:1601
INET6: 3ffe:4:0:1::1 , subnet is 3ffe:4:0:1::/64
Joined group addr83T(es):
ff02::2
ff01::1

```

```

ff02::1
ff02::1:ff00:1
MTU is 1480 bytes
ICMP error messages limited to one every 100 milliseconds
ICMP redirects are enabled
ND DAD is enabled, number of DAD attempts: 1
ND reachable time is 30000 milliseconds
ND advertised reachable time is 0 milliseconds
ND retransmit interval is 1000 milliseconds
ND advertised retransmit interval is 0 milliseconds
ND router advertisements are sent every 200 seconds<160--240>
ND router advertisements live for 1800 seconds
    
```

IPv6

- ' IPv6
- '
- ' 6to4
- ' ISATAP
- ' ISATAP 6to4

IPv6

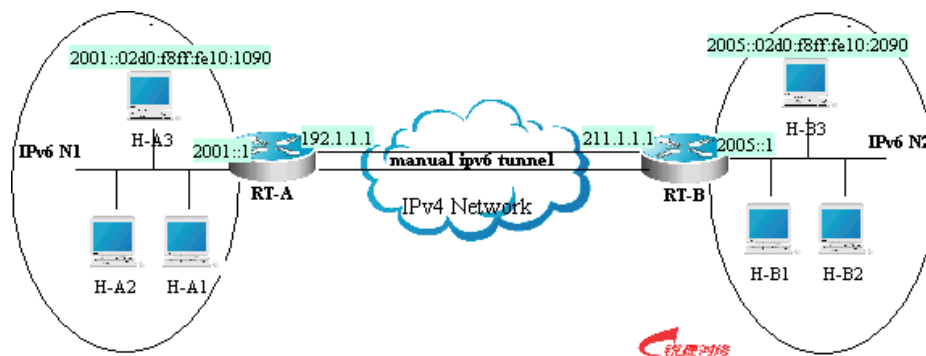

4

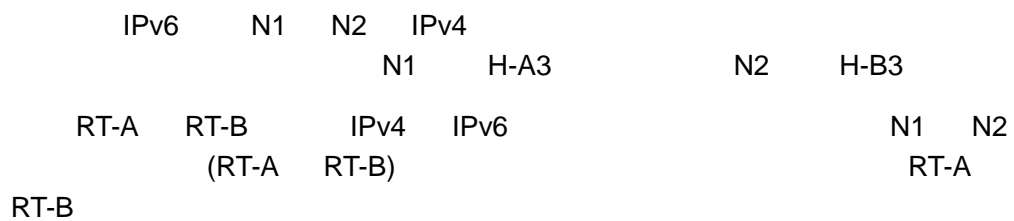

IPv4

RT-A

```
# IPv4
interface FastEthernet 2/1
no switchport
ip address 192.1.1.1 255.255.255.0
```

```
# IPv6
interface FastEthernet 2/2
no switchport
ipv6 address 2001::1/64
no ipv6 nd suppress-ra ( )
```

```
#
interface Tunnel 1
tunnel mode ipv6ip
ipv6 enable
tunnel source FastEthernet 2/1
tunnel destination 211.1.1.1
```

```
#
ipv6 route 2005::/64 tunnel 1
```

RT-B

```
# IPv4
interface FastEthernet 2/1
no switchport
ip address 211.1.1.1 255.255.255.0
```

```
# IPv6
interface FastEthernet 2/2
no switchport
ipv6 address 2005::1/64
no ipv6 nd suppress-ra ( )
```

```
#
interface Tunnel 1
tunnel mode ipv6ip
ipv6 enable
tunnel source FastEthernet 2/1
tunnel destination 192.1.1.1
```

```
#
ipv6 route 2001::/64 tunnel 1
```

6to4

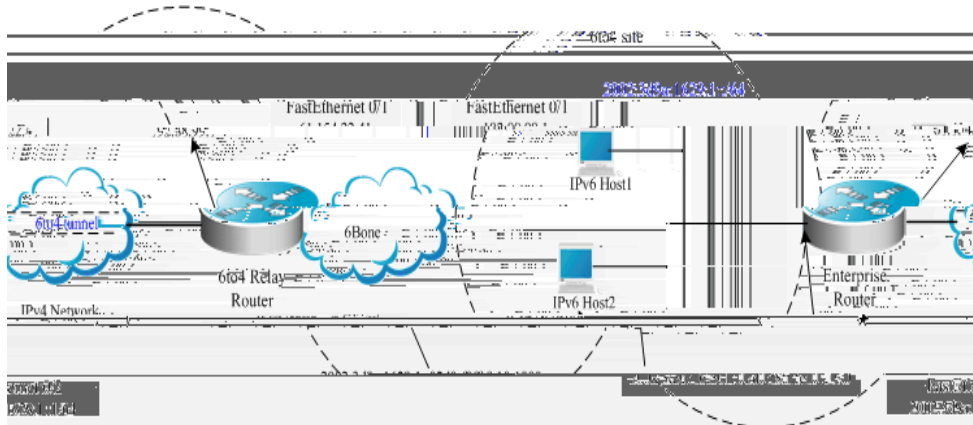

5

IPv6 (6to4) 6to4 6to4 IPv6
 (6bone)
 6to4 IPv6
 6to4 6to4
 IPv6 IPv4 6to4
 6to4
 61.154.22.41 3d9a:1629
 192.88.99.1 c058:6301

r

6to4 IPv4 6to4

2 IPv4 IPv4

Enterprise Router

```
# IPv4
interface FastEthernet 0/1
npSFinteface FastEt8chportTD(npSFinteface ip address (1)-4( )TJ1 25Tj/T
interface FastEthernet 0/1
```

```
#    6to4
interface Tunnel 1
 tunnel mode ipv6ip 6to4
 ipv6 enable
 tunnel source FastEthernet 0/1

#
ipv6 route 2002::/16 Tunnel 1

#    6to4          ,          6bone
ipv6 route ::/0 2002:c058:6301::1
```

ISP 6to4 Relay Router

```
#    IPv4
interface FastEthernet 0/1
 no switchport
 ip address 192.88.99.1 255.255.255.0

#    6to4
interface Tunnel 1
 tunnel mode ipv6ip 6to4
 ipv6 enable
 tunnel source FastEthernet 0/1

#
ipv6 route 2002::/16 Tunnel 1
```

ISATAP

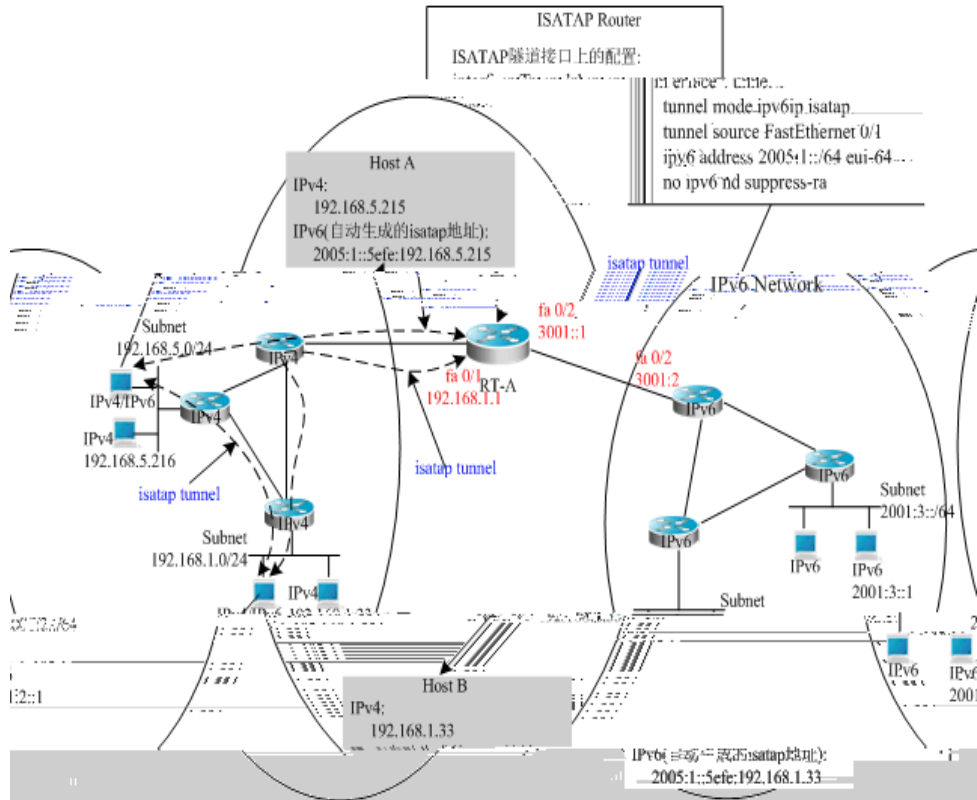

6

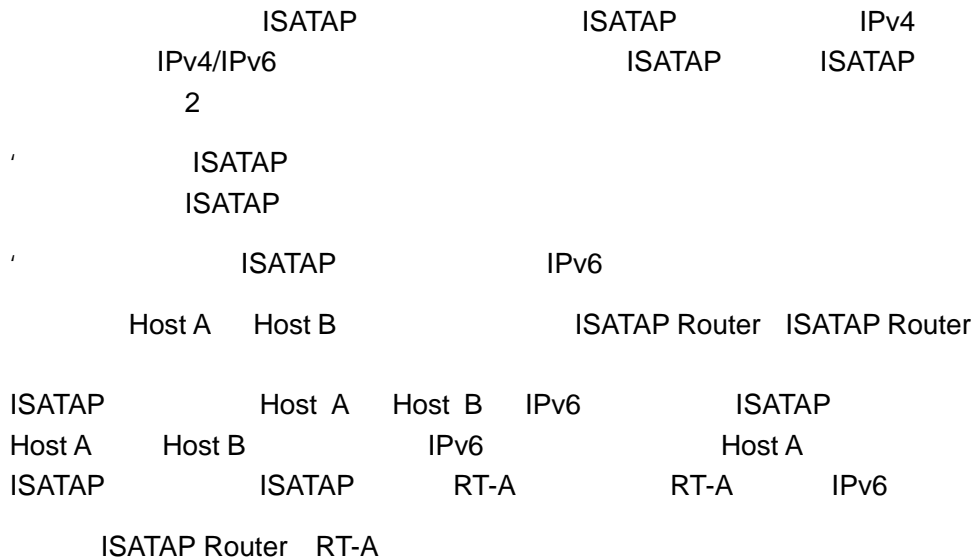

```
# IPv4
interface FastEthernet 0/1
no switchport
ip address 192.168.1.1 255.255.255.0

# ISATAP
interface Tunnel 1
```

```
tunnel mode ipv6ip isatap  
tunnel source FastEthernet 0/1
```

r

IP 6to4 Relay
 IP 6to4 Relay
 6to4 Relay

6to4

RT-A

```
#     Internet
interface GigabitEthernet 0/1
no switchport
ip address 211.162.1.1 255.255.255.0
#
```

```
ipv6 route ::/0 2002:d3a2::0901::1
```

RT-B

Internet

```
interface GigabitEthernet 0/1
no switchport
ip address 211.162.5.1 255.255.255.0
```

IPv4 1

```
interface FastEthernet 0/1
no switchport
ip address 192.168.10.1 255.255.255.0
```

IPv4 2

```
interface FastEthernet 0/2
no switchport
ip address 192.168.20.1 255.255.255.0
```

ISATAP

```
interface Tunnel 1
tunnel mode ipv6ip isatap
tunnel source FastEthernet 0/1
ipv6 address 2002:d3a2:0501:1::/64 eui-64
no ipv6 nd suppress-ra
```

6to4

```
interface Tunnel 2
tunnel mode ipv6ip 6to4
ipv6 enable
tunnel source GigabitEthernet 0/1
```

6to4

```
ipv6 route 2002::/16 Tunnel 2
```

6to4

```
RT-D , Cernet
ipv6 route ::/0 2002:d3a2::0901::1
```

RT-C

Internet

```
interface GigabitEthernet 0/1
no switchport
ip address 211.162.7.1 255.255.255.0
```

IPv4

```
interface FastEthernet 0/1
no switchport
ip address 192.168.0.1 255.255.255.0
```

ISATAP

```
interface Tunnel 1
```

```
tunnel mode ipv6ip isatap
tunnel source FastEthernet 0/1
ipv6 address 2002:d3a2:0701:1::/64 eui-64
no ipv6 nd suppress-ra

# IPv6
interface FastEthernet 0/2
no switchport
2002:d3a2:0701:10::1/64

# 6to4
interface Tunnel 2
tunnel mode ipv6ip 6to4
ipv6 enable
tunnel source GigabitEthernet 0/1

# 6to4
ipv6 route 2002::/16 Tunnel 2

# 6to4 RT-D , Cernet
ipv6 route ::/0 2002:d3a2::0901::1

RT-D(6to4 Relay)

# Internet
interface GigabitEthernet 0/1
no switchport
ip address 211.162.9.1 255.255.255.0

# IPv6
interface FastEthernet 0/1
no switchport
2001::1/64
no ipv6 nd suppress-ra

# 6to4
interface Tunnel 1
tunnel mode ipv6ip 6to4
ipv6 address 2002:d3a2::0901::1/64
tunnel source GigabitEthernet 0/1

# 6to4
ipv6 route 2002::/16 Tunnel 1
```

OSPFv3

OSPF 2 RFC2328 OSPFv2 IPv4 RFC2740 OSPF
3 OSPFv3 OSPFv2 IPv6
OSPFv3 OSPFv3

r

OSPFv2 OSPFv2 OSPFv3
OSPFv2

OSPFv3

OSPF Interior Gateway Protocol IGP
AS
OSPF
link-state advertisements(LSAs)
Dijkstra algorithm OSPF
OSPFv3 RFC2740 IPv6 OSPFv2 OSPFv3

LSA

OSPF LSA LSA
IPv4 IPv6 128 IP
LSA LSA
Router-LSAs (Type 1)
OSPFv2 OSPFv3 Router-LSAs
router
RFC27ü RFC27989

router(ABR) AS boundary routers (ASBR
) virtual link()

' Network-LSAs (Type 2)

Network-LSAs NBMA DR()
 routers Router-LSAs

Network-LSAs
 Network-LSAs Router-LSAs

' Inter-Area-Prefix-LSAs (Type 3)

ABR OSPFv2
 type 3 summary-LSAs OSPFv2

' Inter-Area-Router-LSAs (Type 4)

ABR ASBR
 OSPFv2 type 4 summary-LSAs

' AS-external-LSAs (Type 5)

ASBR LSA AS
 OSPFv2

' NSSA-LSA (Type 7)

type 5 AS-external-LSAs NSSA ASBR

' Link-LSAs (Type 8)

OSPFv3 LSA
 IPv6

∅ Intra-Area-Prefix-LSAs (Type 9)

OSPFv3 LSA Router-LSA Network-LSA

1) network-LSA transit network

2) router-LSA router

		110
		110
		100 Mbps
		240
		SPF 5 10

OSPFv3



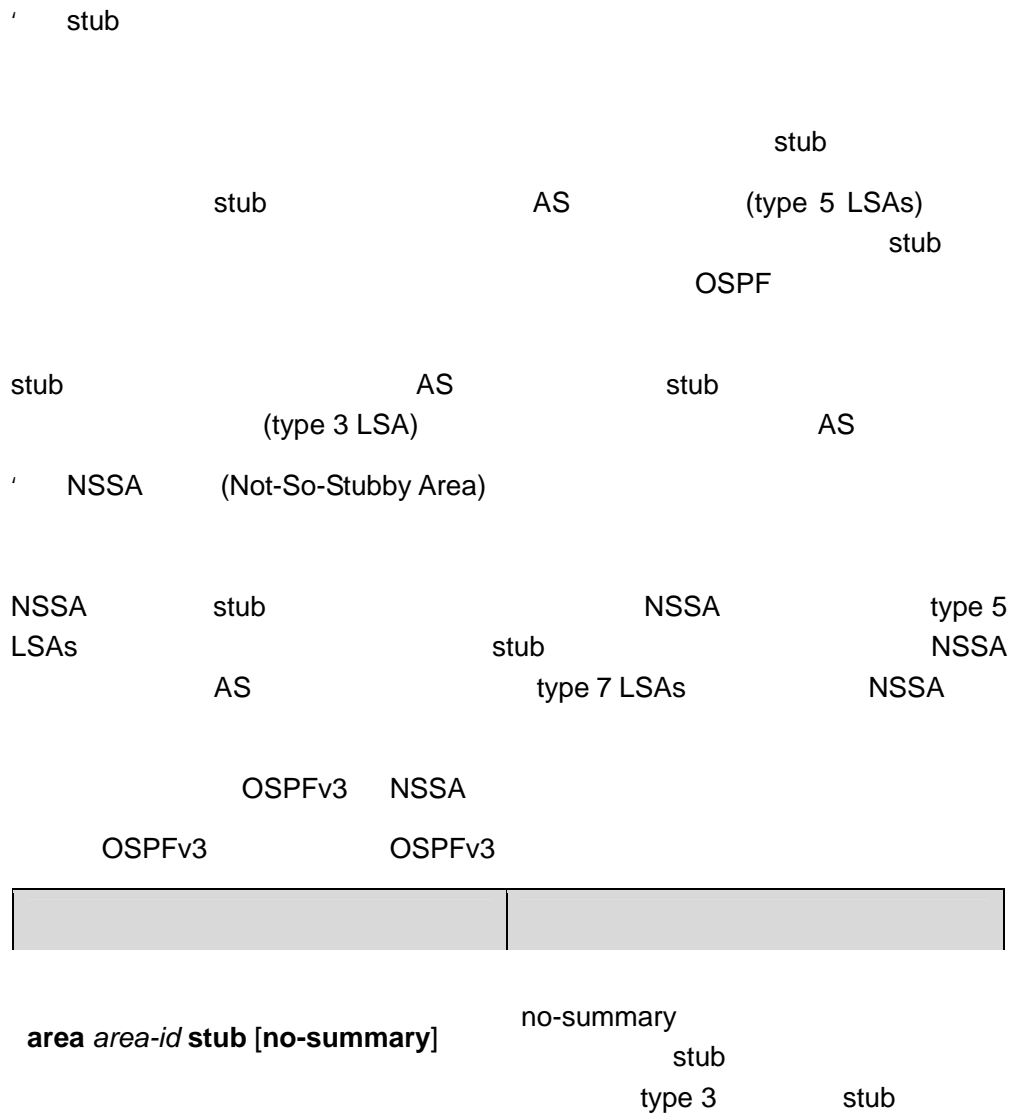

area <i>area-id</i> virtual-link <i>router-id</i> [hello-interval <i>seconds</i>] [dead-interval <i>seconds</i>] [transmit-delay <i>seconds</i>] [retransmit-interval <i>seconds</i>] [instance <i>instance-id</i>]	

no

r

1. **stub** **NSSA**

2.

instance **hello-interval** **dead-interval**

OSPFv3

G

OSPFv3

OSPFv3

auto-cost [reference-bandwidth <i>ref-bw</i>]	

r

ipv6 ospf cost *cost-value*

OSPFv3

OSPF

OSPFv3

Stub

Type 3 LSA

Type5 LSA

OSPF

OSPFv3

default-information originate [always] [metric <i>metric-value</i>] [metric-type <i>type-value</i>] [route-map <i>map-name</i>]	

no default-information originate

r

1) Stub

2) ASBR

OSPFv3

OSPF

OSPF
SPF

SPF

SPF

OSPFv3

<code>timers spf delay holdtime</code>	SPF SPF

OSPFv3

OSPFv3

E - / B

show ipv6 ospf [<i>process- id</i>] neighbor [<i>interface-type interface-number [detail]</i>] <i>neighbor-id [detail]</i>	OSPFv3
show ipv6 ospf [<i>process-id</i>] route	OSPFv3
show ipv6 ospf [<i>process-id</i>] topology [area <i>area-id</i>]	OSPFv3
show ipv6 ospf [<i>process-id</i>] virtual-links	OSPFv3

IPv4

IPV4

IANA	D	D	1110
224.0.0.0	239.255.255.255		
	224.0.0.1	224.0.0.255	
224.0.0.1			224.0.0.2

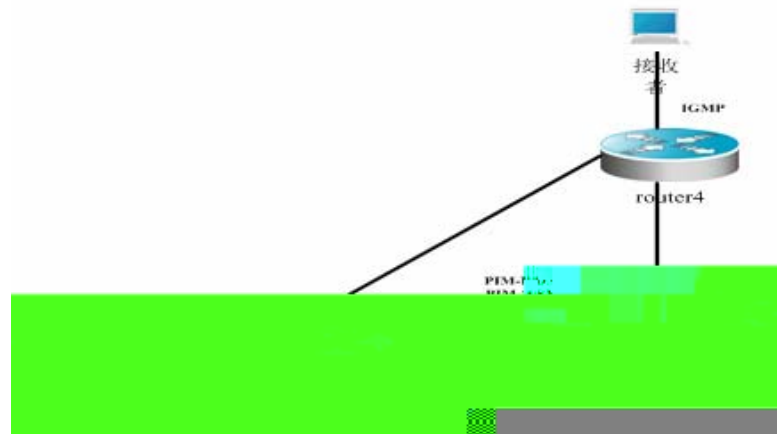

1 IPv4

IGMP

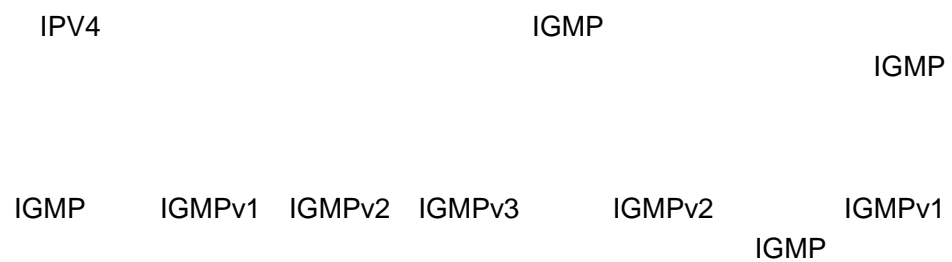

IGMPV1

- 1
- ' Membership query
- ' Membership report
- report
- query

IGMPV2

- 2
- 1) Membership query
- 2) Version 1 membership report
- 3) Version 2 membership report
- 4) Leave group

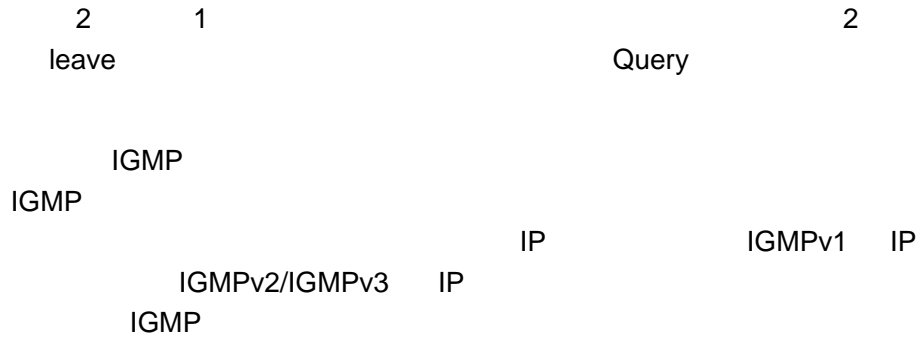

IGMPV3

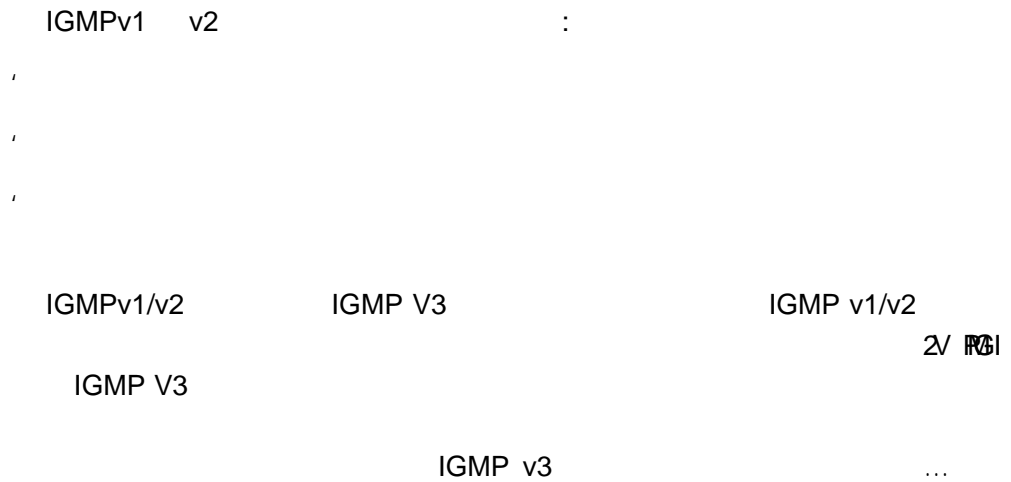

```

' IS_EX                                EXCLUDE

' TO_IN                                EXCLUDE
  INCLUDE

' TO_EX                                INCLUDE
  EXCLUDE

' ALLOW
  INCLUDE
  EXCLUDE

' BLOCK
  INCLUDE
  EXCLUDE

```

IGMPv3

IGMPv1/IGMPv2

PIM-SM

```

PIM(Protocol Independent Multicast)  IDMR
  PIM
    RPF
      PIM
      PIM
        Internet
        Sparse-Mode
        SPT
        PIM
        (Dense-Mode)
        Sparse-Mode
PIM-SM(Protocol Independent Multicast Sparse Mode)
  PIM-SM
  PIM-SM
  DR
  Hello
  DR
  " / "

```

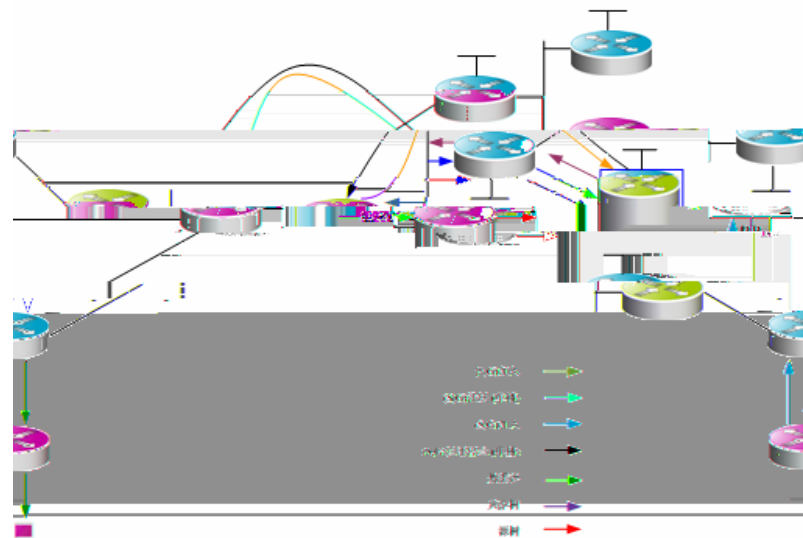

5 pim-sm

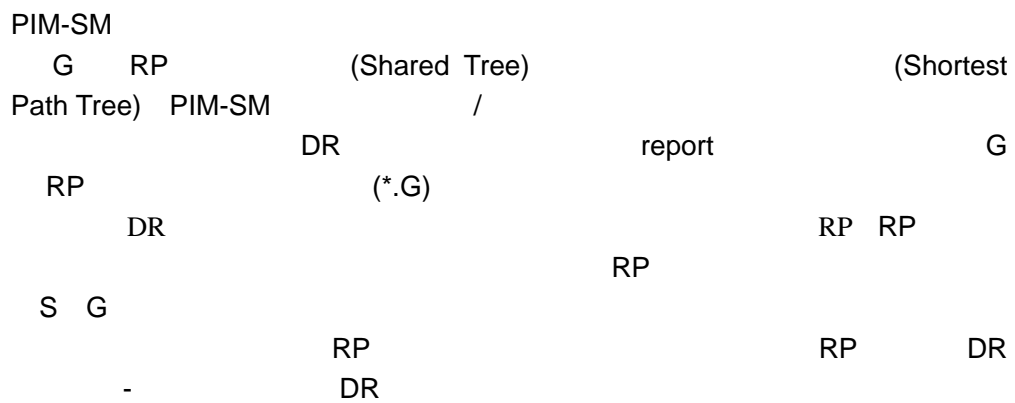

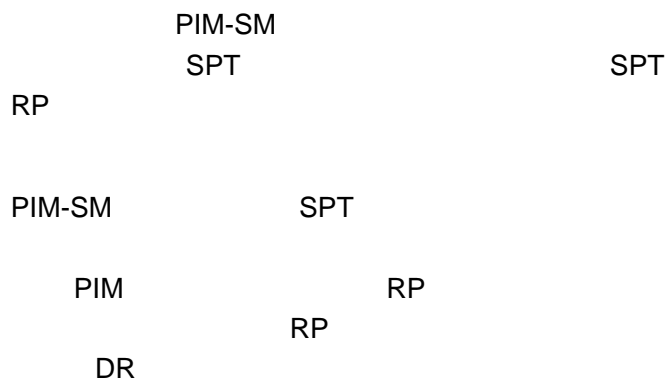

Pruned

PIM-DM Assert

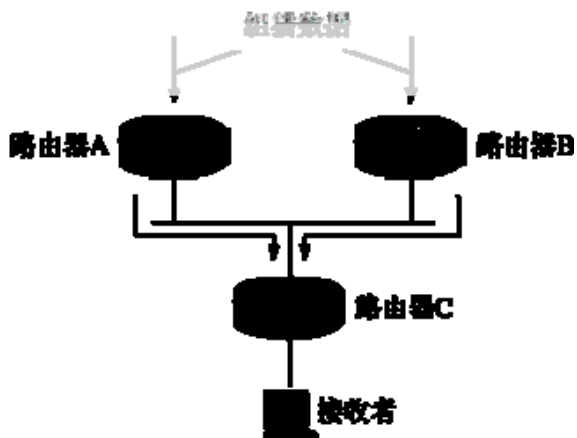

4 PIM-DM Assert

1 C C A B C A B C PIM-DM Assert

PIM-DM State Refresh Message

PIM-DM Graft S, G

Graft-Ack

RPF

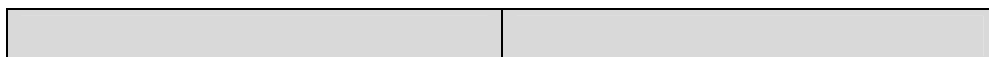

IPV4

TTL

	ttl	TTL
	ip multicast ttl-threshold	
TTL	no ip multicast ttl-threshold	1
TTL	0	
Ruijie(config-if) # ip multicast ttl-threshold <i>ttl-value</i>	TTL ttl-value <0-255>	

IPV4

	ip multicast route-limit <i>limit</i> [<i>threshold</i>]
	no
1024	

limit

Ruijie(config) # **ip**
multicast
route-limit *limit*
[*threshold*]

IPV4

Ruijie# show ip mroute [<i>v4group-address</i>] [<i>v4 source-address</i>] [dense sparse][summary count]	v4

v4

Ruijie# clear ip mroute { * <i>v4group-address</i> [<i>v4source -address</i>]	v4

v4

Ruijie# clear ip mroute statistics { * <i>v4 group-address</i> [<i>v4source -address</i>]	v4

v4 RPF

Ruijie# show ip rpf <i>v4source-address</i>	v4 RPF

v4

Ruijie# show ip mvif [<i>interface-type interface-number</i>]	v4

Ruijie# debug nsm mcast all	

v4

Ruijie# debug nsm mcast fib-msg	v4

v4

--	--

Ruijie# debug nsm mcast vif	v4
------------------------------------	----

v4

Ruijie# debug nsm mcast stats	v4

IGMP

IGMP

```
'          IGMP
'          IGMP
'
'
'
'
'
'
'
'
'
'          join-group( )
'          static-group( )
'          IGMP
'          IGMP PROXY-SERVICE
'          IGMP MROUTE-PROXY
'          IGMP SSM-MAP
'          IGMP SSM-MAP STATIC
'          IGMP
'          IGMP
'
'          IGMP
'          IGMP SSM-MAP
'          IGMP
```

IPV4

IG

2

10

10

Ruijie(config-if) # no ip igmp version	IGMP
--	------

0.1s) 10(

:

Ruijie(config-if) # ip igmp last-member-query-interval interval	interval <1-255> 0.1s
Ruijie(config-if) # no ip igmp last-member-query-interval	

1.

Ruijie(config-if) # ip igmp last-member-query-count count	2-7 2
Ruijie(config-if) # no ip igmp last-member-query-count	

224.0.0.1 TTL 1 125 all-hosts

Ruijie(config-if) # no ip igmp query-interval	
--	--

Ruijie (config) # access-list <i>access-list-num</i> permit <i>A.B.C.D A.B.C.D</i>	
Ruijie (config)# interface <i>interface-id</i>	
Ruijie (config-if) # ip igmp access-group <i>access-list-name</i>	<i>access-list-name</i>
Ruijie (config-if) # no ip igmp access-group	

IGMP version2

Ruijie # config terminal	
Ruijie(config)# access-list <i>access-list-num</i> permit <i>A.B.C.D A.B.C.D</i>	
Ruijie (config)# interface <i>interface-id</i>	
Ruijie(config-if)# ip igmp immediate-leave group-list <i>access-list-name</i>	<i>access-list-name</i>
Ruijie (config-if) # exit	

no ip igmp join-group *group-address*

static-group

no

Ruijie # config terminal	
Ruijie (config)# interface <i>interface-id</i>	
Ruijie(config-if)# ip igmp static-group <i>group-address</i>	
Ruijie (config-if) # exit	

no ip igmp static-group *group-address*

IGMP

IGMP

IGMP

Ruijie(config) # ip igmp limit <i>number</i>	IGMP 65536
Ruijie(config-if) # ip igmp limit <i>number</i>	IGMP

Ruijie# clear ip igmp group	IGMP igmp group
------------------------------------	--------------------

IGMP SSM-MAP

IGMP SSM-MAP

Ruijie# show ip igmp ssm-mapping	IGMP SSM-MAP
Ruijie# show ip igmp ssm-mapping 233.3.3.3	IGMP SSM-MAP 233.3.3.3

IGMP

IGMP

Ruijie# show debugging	IGMP

IGMP

IGMP

IGMP

IGMP

Ruijie# debug ip igmp all	IGMP
Ruijie# debug ip igmp decode	IGMP
Ruijie# debug ip igmp encode	IGMP
Ruijie# debug ip igmp events	IGMP
Ruijie# debug ip igmp fsm	IGMP
Ruijie# debug ip igmp tib	IGMP
Ruijie# debug ip igmp warning	IGMP

PIM-SM

PIM-SM

```
' PIM-SM
' Hello
```

' DR
' RP
' BSR
' RP-SET RP
' RP
' RP
'
'
' cisco HizHiz

PIM

/

ip pim neighbor-filter

ACL

PIM

PIM

ACL

DR

Ruijie(config-if # ip pim dr-priority <i>priority-value</i>	<i>priority-value</i> <0-4294967294>
Ruijie(config-if # no ip pim dr-priority <i>priority-value</i>	1

RP

RP

RP
PIM-SM

PIM-SM

PIM-SM

Ruijie(config # ip pim rp-address <i>rp-address</i> [<i>access-list</i>]	RP
Ruijie(config # no ip pim rp-address <i>rp-address</i> [<i>access-list</i>]	RP

r

' BSR RP RP
' RP ACL
' ACL RP
' RP IP RP

ACL

0.0.0.0/0

PIM-SM

RP

Ruijie(config # ip pim rp-candidate interface-type interface-number [priority priority-value] [interval interval-seconds] [group-list access-list]	RP priority priority-value 192 priority-value <0-255> interval interval-seconds 60s interval-seconds <1-16383> group-list access-list 224/4
Ruijie(config # no ip pim rp-candidate interface-type interface-number	RP

RP acl
permit ace deny ace

r
ace

RP

DR RP RP
RP DR RP RP
RP RP

Ruijie(config # ip pim register-rp-reachability	RP
Ruijie(config # no ip pim register-rp-reachability	

RP

RP

RP

ACL

Ruijie(config # ip pim accept-register list <i>access-list</i>	
Ruijie(config # no ip pim accept-register	

DR

S G

Ruijie(config # ip pim register-rate-limit <i>rate</i>	<i>rate</i> <1-65535>
Ruijie(config # no ip pim register-rate-limit	

cisco

cisco

Ruijie(config # ip pim cisco-register-checksum [group-list <i>access-list</i>]	cisco group-list <i>access-list</i>

Ruijie(config) # no ip pim cisco-register-checksum [group-list access-list]	cisco group-list access-list
--	--

DR
no DR

Ruijie(config) # ip pim register-source { <i>local-address</i> <i>Interface-type interface-number</i> }	
Ruijie(config) # no ip pim register-source	RPF

DR DR
ip pim rp-register-kat RP
RPkeepalive

Ruijie(config) # ip pim register-suppression <i>seconds</i>	[11 21843]
Ruijie(config) # no ip pim register-suppression	60

RP KAT

RP (S,G)

Ruijie(config) # ip pim rp-register-kat <i>seconds</i>	KAT <i>seconds</i> [1 65535]
---	---------------------------------

Ruijie(config # no ip pim rp-register-kat	KAT
--	-----

r

RP DR * 3 +

dense-mode mib

```

    dense-mode mib
sparse-mode mib

```

Ruijie(config) # ip pim mib dense-mode	dense-mode mib
Ruijie(config) # no ip pim mib dense-mode	sparse-mode mib

RP

Ruijie(config) # ip pim ssm {default range access-list}	
Ruijie(config) # no ip pim ssm	

PIM-SM

```

PIM-SM show
PIM-SM show
PIM-SM

```

--	--

Ruijie# show ip pim sparse-mode rp-hash <i>group-address</i>	<i>group-address</i> RP
Ruijie# show ip pim sparse-mode rp mapping	RP

PIM-SM

PIM-SM

Ruijie# clear ip mroute { * <i>group_address</i> [<i>source_address</i>] }	
Ruijie# clear ip mroute statistics { * <i>group_address</i> [<i>source_address</i>] }	
Ruijie# clear ip pim sparse-mode bsr rp-set *	RP-SET

PIM-DM

GabitEthernet 0/3 PIM

```
Ruijie(config)# ip multicast-routing
Ruijie(config)# interface gabitEthernet 0/3
Ruijie(config-if)# ip address 192.168.194.2 255.255.255.0
Ruijie(config-if)# ip pim dense-mode
```

r

PIM-DM

“Failed to enable PIM-DM on < >, resource temporarily unavailable, please try again”

“PIM-DM Configure failed! VIF limit exceeded in NSM!!!”

PIM-DM PIM-DM
PIM-SM

/ v4

Hello

PIM-DM Hello Hello

Hello

Ruijie(config-if #ip pim query-interval interval-seconds	Hello interval-seconds <1-65535>
Ruijie(config-if #no ip pim query-interval	Hello

Hello 30

/

Hello Hello Hello hold time
Hello Hello 3.5 Hello * 3.5 > 65535
Hello 65535

PIM

PIM-DM

PIM

Ruijie(config-if) #ip pim neighbor-filter access-list	PIM
Ruijie(config-if) #no ip pim neighbor-filter access-list	PIM

PIM

/

ip pim neighbor-filter

ACL

PIM

PIM

ACL

PIM

PIM-DM
PIM

RPF

PIM-DM

PIM-DM

Ruijie(config) #ip pim state-refresh disable	PIM-DM
Ruijie(config) #no ip pim state-refresh disable	PIM-DM

r

PIM-DM

PIM

PIM-DM

PIM

PIM

Ruijie(config-if) #ip pim state-refresh origination-interval interval-seconds	PIM <i>interval-seconds</i> <1-100>
Ruijie(config-if) #no ip pim state-refresh origination-interval	PIM

PIM

60

/

PIM

PIM

PIM-DM

PIM-DM show

PIM-DM show

PIM-DM

Ruijie# show ip pim dense-mode interface [interface-type interface-number] [detail]	PIM-DM
Ruijie# show ip pim dense-mode neighbor [interface-type interface-number]	PIM-DM
Ruijie# show ip pim dense-mode nexthop	PIM-DM
Ruijie# show ip pim dense-mode mroute [A.B.C.D A.B.C.D] [summary]	PIM-DM

PIM-DM

1. show ip pim dense-mode interface detail :

```
Ruijie# show ip pim dense-mode interface detail
FastEthernet 0/45 (vif-id: 3):
Address 10.10.10.10
Hello period 30 seconds, Next Hello in 15 seconds
Over-ride interval 2500 milli-seconds
Propagation-delay 500 milli-seconds
Neighbors:
10.10.10.1
VLAN 4 (vif-id: 2):
Address 50.50.50.50
Hello period 30 seconds, Next Hello in 2 seconds
Over-ride interval 2500 milli-seconds
Propagation-delay 500 milli-seconds
Neighbors:
50.50.50.1
```

	FastEthernet 0/45	IP	10.10.10.10	Hello	
30	Hello	15		10.10.10.1	VLAN
4	FastEthernet 0/45				

2. show ip pim dense-mode neighbor

```
Ruijie# show ip pim dense-mode neighbor
Neighbor-Address Interface Uptime/Expires Ver
10.10.10.1 FastEthernet 0/45 00:19:29/00:01:21 v2
50.50.50.1 VLAN 4 00:22:09/00:01:39 v2
```

Neighbor-Address	Interface	Uptime/Expires	Ver
10.10.10.1	FastEthernet 0/45	00:19:29/00:01:21	v2
50.50.50.1	VLAN 4	00:22:09/00:01:39	v2

3. show ip pim dense-mode nexthop

```
Ruijie# show ip pim dense-mode nexthop
Destination Nexthop Nexthop Nexthop Metric Pref
Num Addr Interface
1.1.1.111 1 50.50.50.1 VLAN 4 0 1
1.1.1.111 50.50.50.1
VLAN4
```

Destination	Nexthop Num	Nexthop Addr	Nexthop Interface	Metric	Pref
1.1.1.111	1	50.50.50.1	VLAN 4	0	1
		1.1.1.111		50.50.50.1	

4. show ip pim dense-mode mroute

```
Ruijie# show ip pim dense-mode mroute
PIM-DM Multicast Routing Table
(1.1.1.111, 229.1.1.1)
MRT lifetime expires in 205 seconds
```

RPF Neighbor: 50.50.50.1, Nexthop: 50.50.50.1, VLAN 4
 Upstream IF: VLAN 4
 Upstream State: Pruned, PLT:200
 Assert State: NoInfo
 Downstream IF List:
 FastEthernet 0/45:
 Downstream State: NoInfo
 Assert State: Loser, AT:170

	(1.1.1.111, 229.1.1.1)	MRT	205
RPF	50.50.50.1	50.50.50.1	VLAN4
	VLAN4	Pruned	
	FastEthernet 0/45	NoInfo	Assert
Loser	FastEthernet 0/45		

PIM-DM

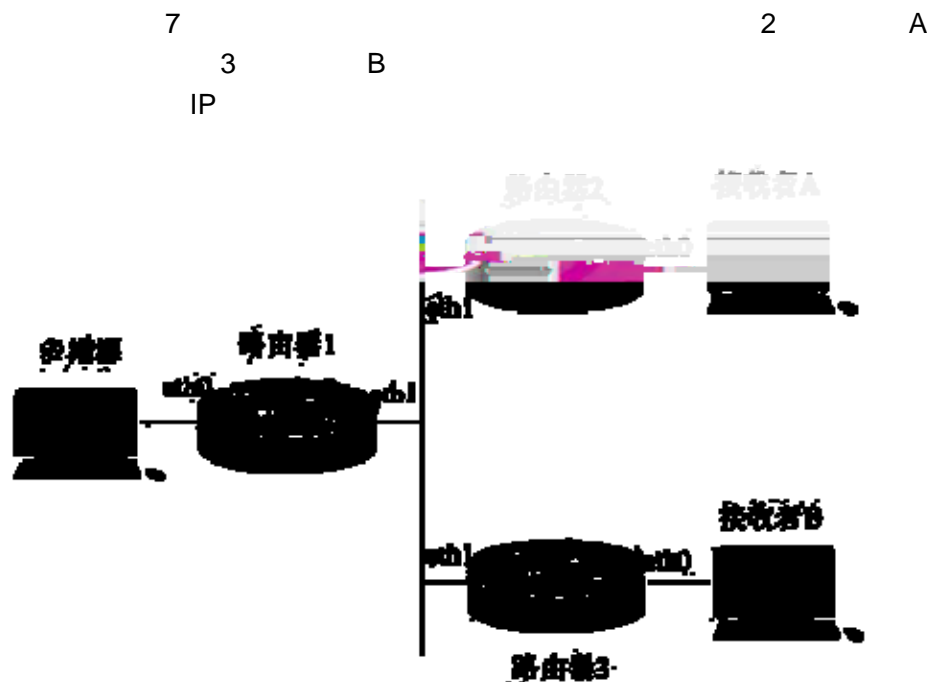

6 PIM-DM

1 PIM-DM 2 3 1

```

Ruijie# configure terminal
Ruijie(config)# ip multicast-routing

2 eth0 PIM-DM

Ruijie(config)# interface eth 0
Ruijie(config-if)# ip pim dense-mode
Ruijie(config-if)# exit

3 eth1 PIM-DM

Ruijie(config)# interface eth 1
Ruijie(config-if)# ip pim dense-mode
Ruijie(config-if)# end

2 3 1
PIM-DM
    
```

PIM-SM

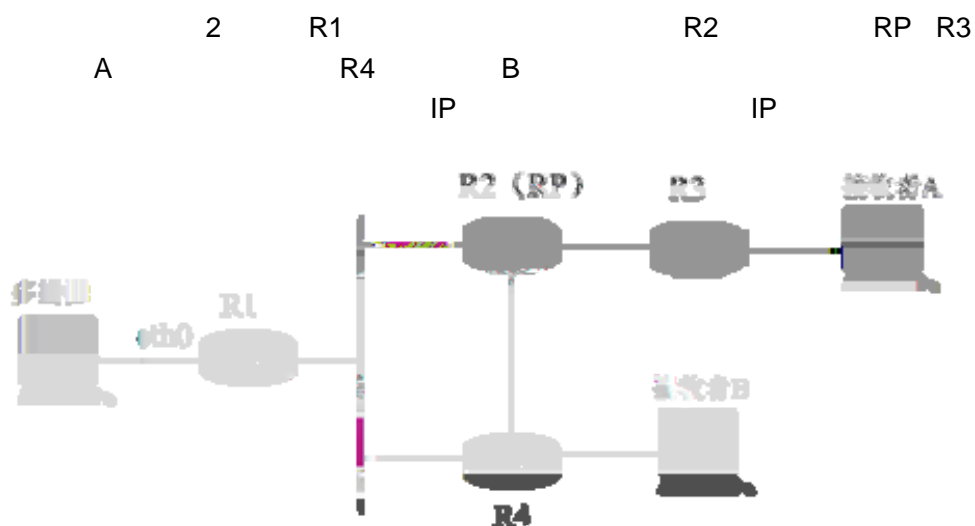

7 PIM-SM

```

R1      IPV4      R2 R3 R4
Ruijie# configure terminal
Ruijie(config)# ip multicast-routing

2      PIM-SM
R1      eth0      PIM-SM      R1 R2 R3 R4

Ruijie(config)# interface eth 0
Ruijie(config-if)# ip pim sparse-mode
Ruijie(config-if)# end

3      BSR      RP
R2      loopback1      C-BSR      C-RP
Ruijie(config)# interface loopback 1
Ruijie(config-if)# ip address 100.1.1.1 255.255.255.0
Ruijie(config-if)# ip pim sparse-mode
Ruijie(config-if)# exit
Ruijie(config)# ip pim bsr-candidate loopback 1
Ruijie(config)# ip pim rp-candidate loopback 1
Ruijie(config-if)# end

PIM-SM      show

/

PIM-SM      IGMP
```

r

1. level
 2. storm-control broadcast
 3. S3760
(level,pps,kbps)
1 level 2 pps AP
3 AP
-

Ruijie# show storm-control [interface-id]	

Gi0/3

```
Ruijie# show storm-control gigabitEthernet 0/3
Interface Broadcast Control Multicast Control Unicast
Control action
GigabitEthernet 0/3 Disabled Disabled Disabled none
```

```
Ruijie# show storm-control
Interface Broadcast Control Multicast Control Unicast
Control Action
-----
GigabitEthernet 0/1 Disabled Disabled Disabled none
GigabitEthernet 0/2 Disabled Disabled Disabled none
GigabitEthernet 0/3 Disabled Disabled Disabled none
GigabitEthernet 0/4 Disabled Disabled Disabled none
GigabitEthernet 0/5 Disabled Disabled Disabled none
GigabitEthernet 0/6 Disabled Disabled Disabled none
GigabitEthernet 0/7 Disabled Disabled Disabled none
GigabitEthernet 0/8 Disabled Disabled Disabled none
```

GigabitEthernet	0/9	Disabled	Disabled	Disabled	none
GigabitEthernet	0/10	Disabled	Disabled	Disabled	none
GigabitEthernet	0/11	Disabled	Disabled	Disabled	none
GigabitEthernet	0/12	Disabled	Disabled	Disabled	none
GigabitEthernet	0/13	Disabled	Disabled	Disabled	none
GigabitEthernet	0/14	Disabled	Disabled	Disabled	none
GigabitEthernet	0/15	Disabled	Disabled	Disabled	none
GigabitEthernet	0/16	Disabled	Disabled	Disabled	none
GigabitEthernet	0/17	Disabled	Disabled	Disabled	none
GigabitEthernet	0/18	Disabled	Disabled	Disabled	none
GigabitEthernet	0/19	Disabled	Disabled	Disabled	none
GigabitEthernet	0/20	Disabled	Disabled	Disabled	none
GigabitEthernet	0/21	Disabled	Disabled	Disabled	none
GigabitEthernet	0/22	Disabled	Disabled	Disabled	none
GigabitEthernet	0/23	Disabled	Disabled	Disabled	none
GigabitEthernet	0/24	Disabled	Disabled	Disabled	none

Protected Port

(Protected Port)

3

3

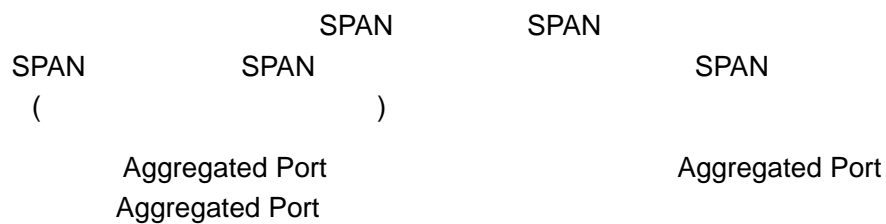

MAC

MAC+ IP

IP

```

'
Aggregate Port
'
SPAN
'
Access Port
802.1x
802.1x

IP+MAC IP ACLs ACLs IP+MAC IP
IP IP IP
) ( IP

```

Ruijie(config-if)# switchport port-security			
Ruijie(config-if)# switchport port-security maximum value	1000	128	1

```
Ruijie(config-if)# switchport
```

8 gigabitethernet 0/3
protect

```
Ruijie# configure terminal  
Enter configuration commands, one per line. End with CNTL/Z.  
Ruijie(config)# interface gigabitethernet 0/3  
Ruijie(config-if)# switchport mode access  
Ruijie(config-if)# switchport port-security  
Ruijie(config-if)# switchport port-security maximum 8  
Ruijie(config-if)# switchport port-security violation protect  
Ruijie(config-if)# end
```

```
/  
1          Ip      Ip+Mac  
Mac  
2          trap   log  
3                          1
```

Ruijie(config-if)# switchport port-security mac-address <i>mac-address</i> [<i>ip-address ip-address</i>]	ip-address() IP

no switchport port-security mac-address

mac-address

```
00d0.f800.073c          gigabitethernet 0/3  
IP          192.168.12.202
```

```
Ruijie# configure terminal  
Enter configuration commands, one per line. End with CNTL/Z.  
Ruijie(config)# interface gigabitethernet 0/3  
Ruijie(config-if)# switchport mode access  
Ruijie(config-if)# switchport port-security  
Ruijie(config-if)# switchport port-security mac-address  
00d0.f800.073c ip-address 192.168.12.202
```

```
Ruijie(config-if)# end
```

Ruijie(config-if)# switchport port-security aging{static time time }	static time 0 1440 0 Time Time 0

```
no switchport port-security aging time  
no switchport port-security aging
```

```
static
```

```
gigabitethernet 0/3
```

```
8
```

```
Ruijie# configure terminal  
Enter configuration commands, one per line. End with CNTL/Z.  
Ruijie(config)# interface gigabitethernet 0/3  
Ruijie(config-if)# switchport port-security aging time 8  
Ruijie(config-if)# switchport port-security aging static  
Ruijie(config-if)# end
```

Ruijie# show port-security interface [interface-id]	
Ruijie# show port-security address	

Ruijie# show port-security address [interface-id]	
Ruijie# show port-security	

Gigabitethernet 0/3

```
Ruijie# show port-security interface gigabitethernet 0/3
Interface : Gi0/3
Port Security: Enabled
Port status : down
Violation mode:Shutdown
Maximum MAC Addresses:8
Total MAC Addresses:0
Configured MAC Addresses:0
Aging time : 8 mins
SecureStatic address aging : Enabled
```

Ruijie# **show port-security address**

```
Vlan Mac Address IP Address Type Port Remaining Age(mins)
-----
1 00d0.f800.073c 192.168.12.202 Configured Gi0/3 8
1 00d0.f800.3cc9 192.168.12.5 Configured Gi0/1 7
```

gigabitstethernet

0/3

```
Ruijie# show port-security address interface gigabitethernet GiTo08 y addr
```

Ruijie(config)# interface <i>interface-id</i>	
Ruijie(config-if)# arp-check	arp
Ruijie(config-if)# no arp-check	arp
Ruijie(config-if)# arp-check auto	

mac 00d0.f822.33ab IP 192.168.2.5

ARP

```
Ruijie#configure terminal
Enter configuration commands, one per line. End with CNTL/Z.
Ruijie(config)# interface fastEthernet 0/5
Ruijie(config-if)# switchport port-security
Ruijie(config-if)# switchport port-security mac-address
00d0.f822.33ab ip-address 192.168.2.5
```

ARP

ARP

```
Ruijie(config-if)# no arp-check
```

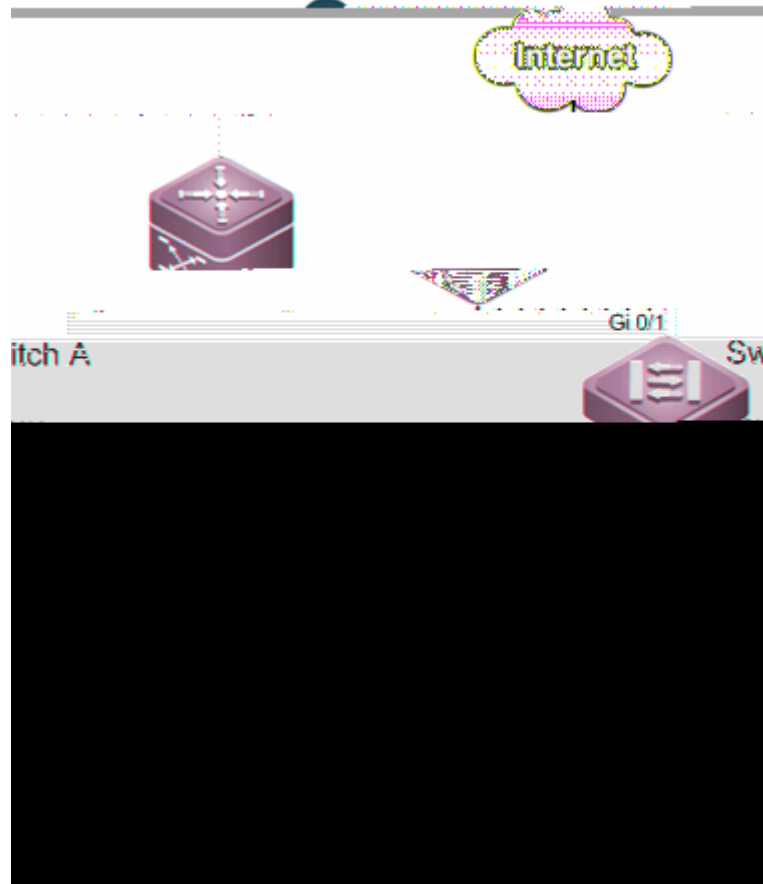

9

- 1
- 2 IP/MAC Switch A IP/MAC
- 3 Switch B IP, MAC
ARP DOS

-
1. Switch A Switch B
 2. Switch A

```
Ruijie(config-if-GigabitEthernet 0/5)#switchport port-security
mac-address 0000.0000.0001 ip-address 1.1.1.1
Ruijie(config-if-GigabitEthernet 0/5)#exit
IP 1.1.1.2 /MAC 0000.0000.0002
```

```
Ruijie(config)#interface gigabitEthernet 0/9
Ruijie(config-if-GigabitEthernet 0/9)#switchport port-security
Ruijie(config-if-GigabitEthernet 0/9)#switchport port-security
mac-address 0000.0000.0002 ip-address 1.1.1.2
Ruijie(config-if-GigabitEthernet 0/9)#exit
```

Ø **Switch B**

VLAN

VLAN 3

```
Ruijie#configure terminal
Enter configuration commands, one per line. End with CNTL/Z.
Ruijie(config)#vlan 3
Ruijie(config-vlan)#exit
Ruijie(config)#interface gigabitEthernet 0/5
Ruijie(config-if-GigabitEthernet 0/5)#switchport access vlan 3
Ruijie(config-if-GigabitEthernet 0/5)#exit
Ruijie(config)#interface gigabitEthernet 0/9
Ruijie(config-if-GigabitEthernet 0/9)#switchport access vlan 3
Ruijie(config-if-GigabitEthernet 0/9)#exit
Ruijie(config)#interface gigabitEthernet 0/1
Ruijie(config-if-GigabitEthernet 0/1)#switchport mode trunk
Ruijie(config-if-GigabitEthernet 0/1)#exit
```

```
Ruijie(config)#interface range gigabitEthernet 0/1,0/5,0/9
Ruijie(config-if-range)#storm-control broadcast
Ruijie(config-if-range)#storm-control multicast
Ruijie(config-if-range)#storm-control unicast
Ruijie(config-if-range)#exit
```

```
Ruijie(config)#interface gigabitEthernet 0/5
Ruijie(config-if-GigabitEthernet 0/5)#switchport protected
Ruijie(config-if-GigabitEthernet 0/5)#exit
Ruijie(config)#interface gigabitEthernet 0/9
Ruijie(config-if-GigabitEthernet 0/9)#switchport protected
Ruijie(config-if-GigabitEthernet 0/9)#exit
```

Switch A

IP+MAC

```
Ruijie#show running-config
vlan 2
!
interface GigabitEthernet 0/1
  switchport mode trunk
  storm-control broadcast
  storm-control multicast
  storm-control unicast
!
interface GigabitEthernet 0/5
  switchport access vlan 2
  switchport port-security mac-address 0000.0000.0001 ip-address
1.1.1.1
  switchport port-security
  storm-control broadcast
  storm-control multicast
  storm-control unicast
!
interface GigabitEthernet 0/9
  switchport access vlan 2
  switchport port-security mac-address 0000.0000.0002 ip-address
1.1.1.2
  switchport port-security
  storm-control broadcast
  storm-control multicast
  storm-control unicast
!
interface GigabitEthernet 0/13
  switchport mode trunk
  storm-control broadcast
  storm-control multicast
  storm-control unicast
```

Switch B

```
Ruijie#show running-config
vlan 3
!
interface GigabitEthernet 0/1
  switchport mode trunk
  storm-control broadcast
  storm-control multicast
  storm-control unicast
!
interface GigabitEthernet 0/5
```

```
switchport access vlan 3
switchport protected
storm-control broadcast
storm-control multicast
storm-control unicast
!
interface GigabitEthernet 0/9
switchport access vlan 3
switchport protected
storm-control broadcast
storm-control multicast
storm-control unicast
```

Switch A

ARP CHECK

```
Ruijie#show port-security all
Vlan Port  Arp-Check  Mac Address  IP Address  Type remaining Age
(mins)
-----
```

802.1X

AAA

802.1x

'
' 802.1x
' 802.1x
' 802.1x



CLI

802.1X



IEEE 802 LAN

IEEE 802.1x

IEEE802.1x Port-Based Network Access Control
LAN

IEEE
IEEE 802 LAN

IEEE 802.1x

"

"

Client-Server

EAPOL

Extensible Authentication Protocol

over LAN

802.1x

Authentication Authorization and Accounting

AAA

' Authentication

· Authorization

RADIUS

Radius Server MicroSoft win2000 Server 802.1x Radius Server Linux
Free Radius Server

EAPOL

RADIUS EAPOL EAPOL MAC
0x888E MAC
01-80-C2-00-00-03

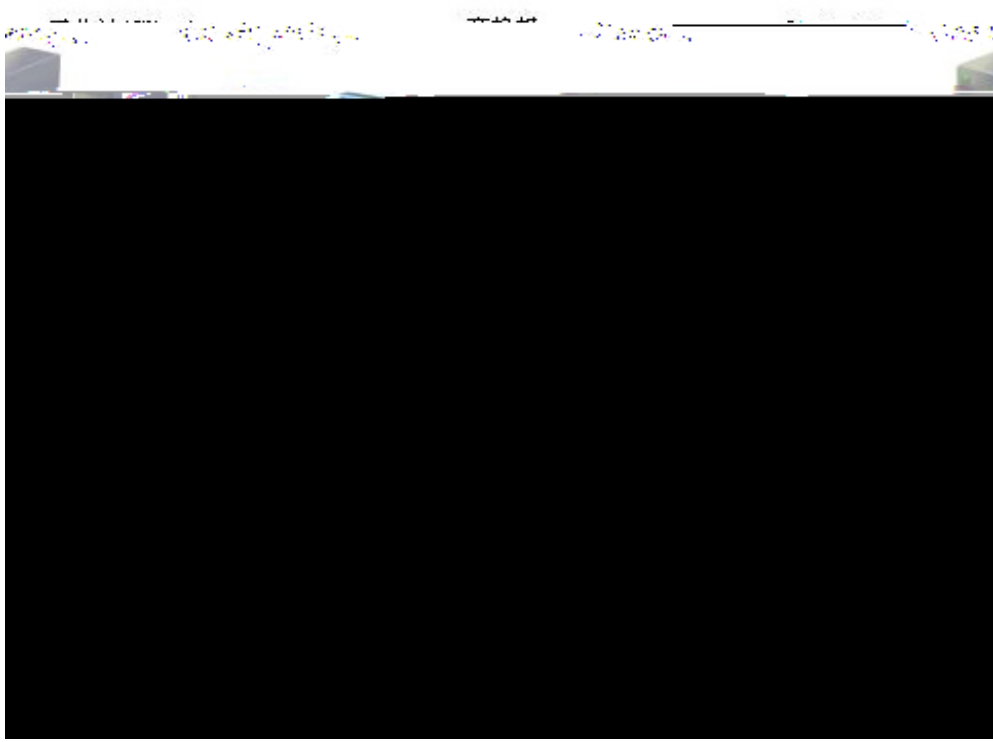

802.1x
802.1X

Authorized
unauthorized
authorized

802.1x

unauthorized

EAPOL-START

802.1x

802.1x
EAPOL-START

802.1x

RADIUS Server
(authorized)

server

RADIUS
unauthorized

EAPOL-LOGOFF
(unauthorized)

(authorized)

(unauthorized) LINK-DOWN

(unauthorized)

MAC

A 802.1x

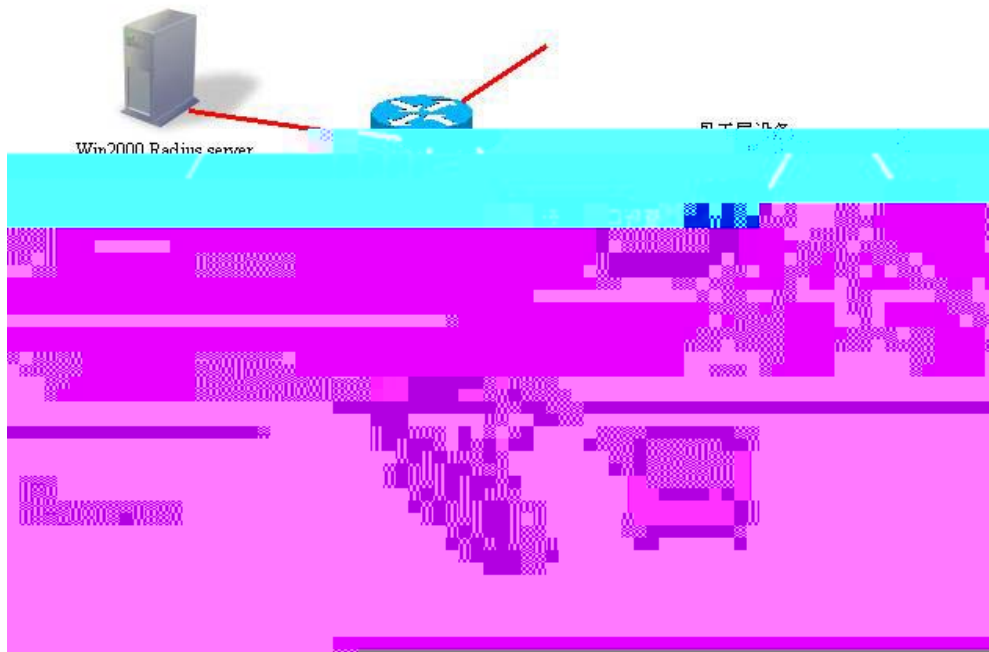

3

,

1. 802.1x 802.1x windowXp
Star-suppliant IEEE802.1x
2. IEEE 802.1x
3. RADIUS

,

1. Radius Server
- 2.

,

1. 802.1x
2. Radius Server 3. 802.1x



4

,

1. 802.1x 802.1x windowXp
Star-suppliant IEEE802.1x
2. IEEE 802.1x (EAPOL)
3. 802.1x
4. RADIUS

,

1. Radius Server

- 2.

,

- 1.

© 2006 Ruijie Technology Co., Ltd. All rights reserved.

802.1X

802.1x

```
' 802.1x
' 802.1x
'      RADIUS SERVER
'      802.1X
'      /
'
'      /      supplicant
'      QUIET
'
'
'      Server-timeout
'      802.1x
'      802.1x
'      IP
'
'
'
'
'      IP
'
'
'      VLAN
'      GUEST VLAN
'
'
'      EAPOL      TAG
```

802.1x

802.1x

Authentication	DISABLE
Accounting	DISABLE
(Radius Server)	*
* IP (ServerIp)	*1812
* UDP	*
* (Key)	
(Accounting Server)	*
* IP	*1813
* UDP	
re-authentication	
reauth_period	3600
	10
	3
	3
	3
	3
	5

802.1X

```

'          802.1x
'
' 802.1x
'
'          IP      radius  server
'
'          1X
'
'  Aggregate Port      1X
'
'          1x          1x
'
cpu

```

RADIUS SERVER

Radius Server

Radius Server

RADIUS SERVER

```

Radius Server          Radius Client          Radius Server
  IP          UDP          UDP          Radius
Server          Client          EAP
  Radius Server          Radius Client

Server          Server          Radius
  IP          UDP

Radius Server
  
```

configure terminal	
aaa new-model	AAA
radius-server host <i>ip-address</i> [auth-port <i>port</i>] [acct-port <i>port</i>]	RADIUS
Radius-server key <i>string</i>	RADIUS Key
end	
write	
show radius server	RADIUS

```

no radius-server host ip-address auth-port          Radius Server
UDP          no radius-server key          Radius Server
server ip 192.168.4.12          Udp 600
  
```

```

Ruijie# configure terminal
Ruijie(config)# radius-server host 192.168.4.12
Ruijie(config)# radius-server host 192.168.4.12 auth-port 600
Ruijie(config)# radius-server key MsdadShaAdasdj878dajL6g6g
a
Ruijie(config)# end
'          UDP          1812
'          UDP          1813
'          Radius Server          16
'          Radius Server
  
```

802.1X

802.1x

1x

configure terminal	
aaa new-model	AAA
radius-server host <i>ip-address</i> [auth-port <i>port</i>] [acct-port <i>port</i>]	RADIUS
Radius-server key string	RADIUS Key
aaa authentication dot1x <i>auth</i> group radius	dot1x
dot1x authentication <i>auth</i>	dot1x
end	
write	
show running-config	

802.1x

```

Ruijie# configure terminal
Ruijie(config)# aaa new-model
Ruijie(config)# radius-server host 192.168.217.64
Ruijie(config)# radius-server key starnet
Ruijie(config)# aaa authentication dot1x authen group radius6 0 4.-0.0686
a auth68 -1.446 Td (Ruijie(config)# )Tj /T <1w13

```

```

interface VLAN 1
 ip address 192.168.217.222 255.255.255.0
 no shutdown
 !
 !
 line con 0
 line vty 0 4
 !
 end

```

```

802.1x          RADIUS          Radius Server  IP
                Radius Server          Radius Server
                        Radius Server

```

/

802.1x

configure terminal	
interface <i>interface</i>	,
dot1x port-control auto	no
end	
write	
show dot1x port-control	802.1x

```

no dot1x port-control
1/1

```

```

Ruijie# configure terminal
Ruijie(config)# interface f 1/1
Ruijie(config-if)# dot1x port-control auto
Ruijie(config)# end

```

EAP

CPU

```

r
S3760 CPU EAP
arp ping
cpu EAP
vlan vlan

```

802.1x

3600

/

configure terminal	
dot1x re-authentication	
dot1x timeout re-authperiod seconds	
End	
Write	
show dot1x	dot1x

```

no dot1x re-authentication no dot1x
timeout re-authperiod

```

1000

```

Ruijie# configure terminal
Ruijie(config)# dot1x re-authentication
Ruijie(config)# dot1x timeout re-authperiod 1000
Ruijie(config)# end
Ruijie# show dot1x
802.1X Status: Disabled
Authentication Mode: EAP-MD5
Authed User Number: 0
Re-authen Enabled: Enabled
Re-authen Period: 1000 sec
Quiet Timer Period: 10 sec

```

```

Tx Timer Period:      3 sec
Supplicant Timeout:   3 sec
Server Timeout:       5 sec
Re-authen Max:        3 times
Maximum Request:      3 times
Filter Non-RG Supp:   Disabled
Client Oline Probe:   Disabled
Eapol Tag Enable:     Disabled
Authorization Mode:    Disabled

```

/ **supplicant**

```

      supplicant      802.1x
      802.1x          (      WindowsXP      802.1x
    )
      supplicant      802.1x
supplicant            802.1x

```

configure terminal	
dot1x private-supplicant-only	
end	
write	
show dot1x	dot1x

supplicant

```

Ruijie# configure terminal
Ruijie(config)# dot1x private-supplicant-only
Ruijie(config)# end
Ruijie# show dot1x
802.1X Status:      enable
Authentication Mode: eap-md5
Total User Number:  0(exclude dynamic user)
Authed User Number: 0(exclude dynamic user)
Dynamic User Number: 0
Re-authen Enabled:  enable
Re-authen Period:   2 sec

```

```

Quiet Timer Period: 10 sec
Tx Timer Period:    3 sec
Supplicant Timeout: 3 sec
Server Timeout:    5 sec
Re-authen Max:    3 times
Maximum Request:   3 times
Private supplicant only: enable
Client Online Probe: disable
Eapol Tag Enable:  disable
Authorization Mode:  disable

```

no dot1x private-supplicant-only

QUIET

```

Quiet Period
Quiet
Period          10
Quiet Period
Quiet Period

```

configure terminal	
dot1x timeout quiet-period <i>seconds</i>	Quiet Period
end	
write	
show dot1x	dot1x

```

no dot1x timeout quiet-period Quiet Period
QuietPeriod 500

```

```

Ruijie# configure terminal
Ruijie (config)# dot1x timeout quiet-period 500
Ruijie(config)# end

```

EAP-request/identity

configure terminal	
dot1x timeout tx-period <i>seconds</i>	
end	
write	
show dot1x	dot1x

```
no dot1x timeout tx-period
    100
```

```
Ruijie# configure terminal
Ruijie(config)# dot1x timeout tx-period 100
Ruijie(config)# end
```

```

          RadiusServer          ServerTimeout          Radius
Server
                                3

```

configure terminal	
dot1x max-req <i>count</i>	
end	
write	
show dot1x	dot1x

```
Ruijie#show dot1x

no dot1x max-req
    5

Ruijie# configure terminal
Ruijie(config)# dot1x max-req 5
Ruijie(config)# end
```

802.1x

802.1x

EAPOL-START

"

"

linkdown

linkup

WindowsXP

802.1x

802.1x

EAP-request/identity

802.1x

/

end	
write	
show dot1x auto-req	

no

configure terminal	
dot1x auto-req req-interval <i>interval</i>	
end	
write	
show dot1x auto-req	

no

) (

--	--

supplicant			
	dot1x auto-req	dot1x auto-req dot1x auto-req packet-num <i>num</i> dot1x auto-req req-interval <i>interval</i> dot1x auto-req user-detect	dot1x auto-req dot1x auto-req packet-num <i>0</i> dot1x auto-req req-interval <i>interval</i> no dot1x auto-req user-detect

802.1x

802.1x

802.1x

802.1x

1. Radius Server Radius Client
2. IP
3. UDP
4. 802.1x

configure terminal	
aaa new-model	AAA

aaa group server radius <i>gs</i>	
server <i>192.168.4.12</i> acct-port <i>11</i>	
exit	
aaa accounting network <i>acct</i> start-stop group <i>gs</i>	
dot1x accounting <i>acct</i>	802.1X
end	
write	
show running-config	

no aaa accounting network
accounting *acct* **dot1x**

no dot1x

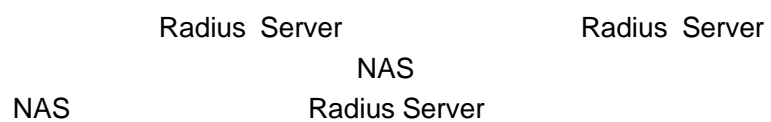

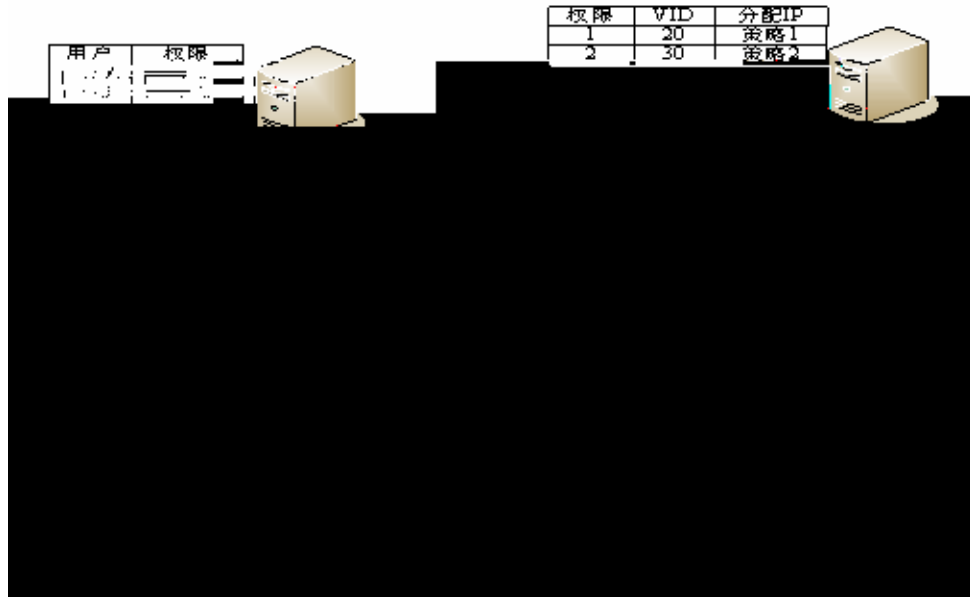

5

```

DHCP Client      IP      dhcp relay option82
SAM              option82  DHCP              option82
" vid + "       DHCP Server option82

DHCP Relay      option82      DHCP relay
option82

RADIUS SERVER   IP      RADIUS SERVER
RADIUS SERVER   IP

SUPPLICANT      IP      SUPPLICANT      PC      IP
IP

'  DISABLE      IP

'  DHCP SERVER   PC      DHCP      IP
DHCP RELAY      DHCP SERVER
DHCP SERVER      IP

'  RADIUS SERVER   PC      IP      RADIUS SERVER
< -IP>          RADIUS      Framed-IP-Address
IP

'  SUPPLICANT      PC      IP      SUPPLICANT
IP
    
```

r

IP

configure terminal	
aaa new-model	AAA
aaa authorization ip-auth-mode {disabled dhcp-server radius-server supplicant }	IP
end	
write	
show running-config	

IP RADIUS-SERVER

```

Ruijie# configure terminal
Ruijie(config)# aaa authorization ip-auth-mode radius-serve
r
Ruijie(config)# end
Ruijie# show running-config
!
aaa new-model
!
aaa authorization ip-auth-mode radius-server
!
Ruijie# write memory

```

802.1x

Radius Server

Reply-Message

802.1x

Star-Supplicant

- 1) Radius Server Reply Message
- 2) r-suppliant
- 3)

802.1x

IEEE 802.1x

MAC

configure terminal	
dot1x auth-address-table address <i>mac-addr</i> interface <i>interface</i>	
end	
write	
show running-config	

r

Radius Server

Radius



6

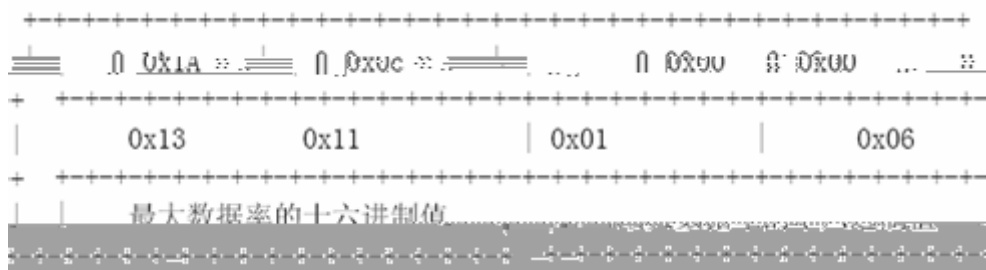

7

kbps
10M

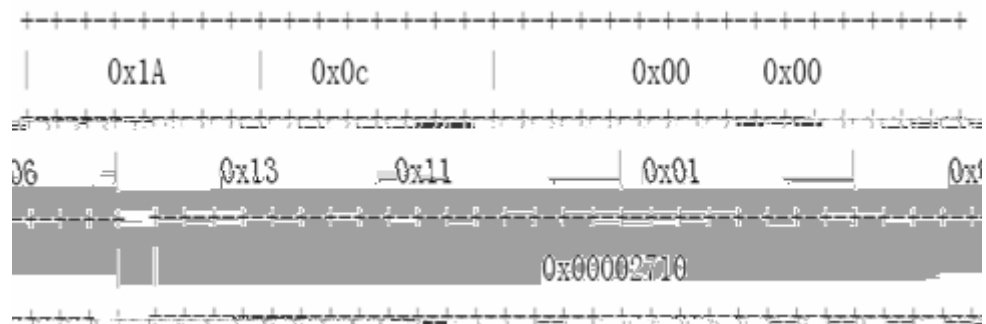

8

10M 10000kbps 16
0x00002710

r

S3760 dscp rate-limit

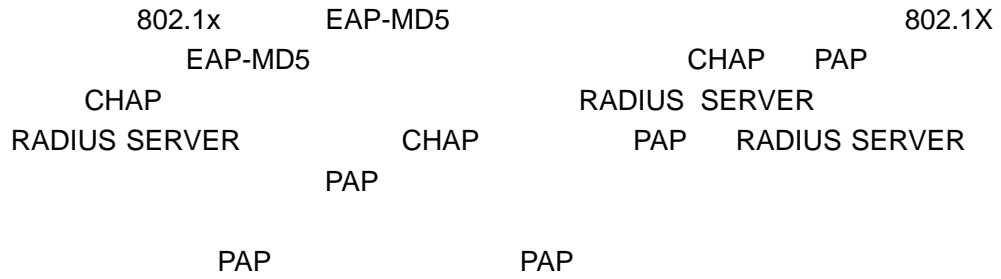

802.1x

configure terminal	
dot1x auth-mode mode	
end	
write	
show dot1x	

CHAP

```
Ruijie# configure terminal
Ruijie (config)# dot1x auth-mode CHAP
Ruijie(config)# end                                end
```

802.1x

configure terminal	
aaa new-model	aaa
aaa group server radius <i>gs-name</i>	
server sever	
server server-backup	
end	
write	
show dot1x	

192.168.4.12

```

Ruijie# configure terminal
Ruijie# aaa new-model
Ruijie(config)# aaa group server radius auth-11
Ruijie(config-gs-radius)# server 192.168.4.1
Ruijie(config-gs-radius)# server 192.168.4.12
Ruijie(config-gs-radius)# end
Ruijie#

```

SNMP

SNMP

IP

IP

Radius Server

IP

802.1X



9

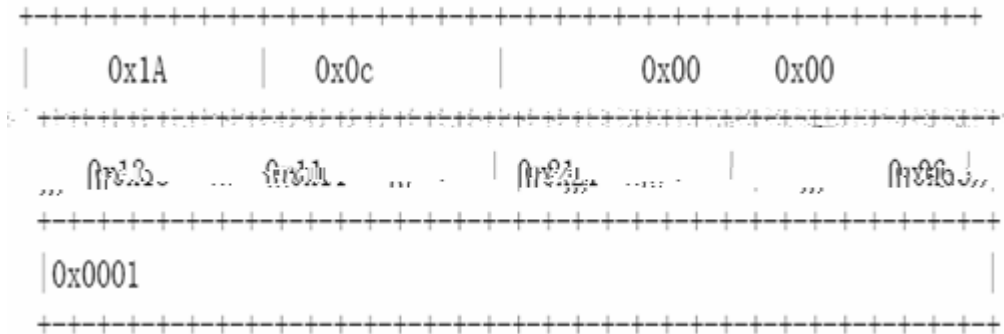

10

RADIUS
RADIUS

) (



- ' Hello Interval:
- ' Alive Interval

configure terminal	
interface <i>interface-id</i>	
dot1x port-control auto	
dot1x port-control-mode { <i>mac-based</i> <i>port-based</i> }	
end	
write	
show dot1x port-control	802.1X

no dot1x port-control-mode

```
Ruijie#configure terminal  
Ruijie(config)#interface fastEthernet 0/4  
Ruijie(config-if)#dot1x port-control-mode port-base
```

r

802.1x

MAC

configure terminal	

single-host

configure terminal	4

```
'      Radius
'
'
'
'      1X
```

Radius

show radius server

Radius Server

show aaa user

```
Ruijie# sh radius server
Server IP:      192.168.5.11
Accounting Port: 1813
Authen Port:   1812
Server State:   Ready
```

802.1X

1x

show dot1x

802.1x

```
Ruijie# show dot1x
802.1X Status:      Disabled
Authentication Mode: EAP-MD5
Authed User Number: 0
Re-authen Enabled:  Disabled
Re-authen Period:   3600 sec
Quiet Timer Period: 10 sec
Tx Timer Period:    3 sec
Supplicant Timeout: 3 sec
Server Timeout:     5 sec
Re-authen Max:      3 times
Maximum Request:    3 times
Filter Non-RG Supp: Disabled
Client Oline Probe: Disabled
Eapol Tag Enable:   Disabled
Authorization Mode:  Disabled
```

802.1x

configure terminal	
dot1x auth-address-table address <i>mac-addr</i> interface <i>interface</i>	
end	
write	
show dot1x auth-address-table	

no dot1x auth-address-table address

```
Ruijie# show dot1x auth-address-table
interface:g3/1
-----
mac addr: 00D0.F800.0001
```

show dot1x summary	

```
Ruijie# show dot1x summary
ID   MAC           Interface  VLAN  Auth-State  Backend-State
Port-Status
-----
1    00d0f8000001  Gi3/1     1     Authenticated  IDLE
Authed
```

1x

1x

show dot1x probe-timer	1x

1x :

```
Ruijie# show dot1x probe-timer
Hello Interval: 20 Seconds
Hello Alive: 250 Seconds
Ruijie#
```

802.1x

```
1. IP 10000
2. 1X ACL
   IP 802.1x ACL MAC
      ACL MAC ACL MAC
      MAC MAC ACL MAC
   ACL MAC
      MAC 00d0.f800.0001 MAC
00d0.f800.0001 ACL ACL
                MAC ICMP
   IP ACL ACL
      IP+MAC
   1 mac: 00d0.f800.0001 ip: 192.168.65.100
   2 mac: 00d0.f800.0002 ip: 192.168.65.101
      ACL
ip access-list extended ip_acl:
deny icmp any any
      IP + MAC ACL ICMP ACL
      ACE deny any any
   IP_acl permit any any IP
   ACL IP + MAC IP
```

3. IP

ACL IP

IP

IP

AAA

AAA

,
,
,
,

AAA

AAA

r



1 AAA

AAA

R1 R2

AAA

RADIUS

R2

R1

AAA

AAA

AAA

AAA

Ruijie(config)# aaa new-model	AAA

AAA

AAA

--	--

Ruijie(config)# **no aaa new-model** ↑ü

AAA

AAA

r

AAA

2

R1

R2

RADIUS

aaa new-model

Telnet (NAS)
NAS

AAA

aaa authentication login

AAA

configure	terminal
aaa new-model	AAA
aaa authentication login {default list-name} method1 [method2...]	
line vty line-num	AAA
login authentication {default list-name}	

*list-name**method*

ERROR
FAIL()

none

RADIUS (TIMEOUT)

aaa authentication login default group radius none

r

none**none****none****none**

local	
none	
group radius	Group RADIUS

AAA

RADIUS

RADIUS

configure terminal	
aaa new-model	AAA
radius-server host <i>ip-address</i> [auth-port <i>port</i>] [acct-port <i>port</i>]	RADIUS
end	
show radius server	RADIUS

```
Ruijie(config)# line vty 0 4
Ruijie(config-line)# login authentication test
Ruijie(config-line)# end
Ruijie# show running-config
!
aaa new-model
!
!
aaa authentication login test group radius local
aaa authentication login terms none
username Ruijie password 0 starnet
!
radius-server host 192.168.217.64
!
line con 0
line aux 0
line tty 1 4
login authentication terms
line tty 5 16
login authentication test
line vty 0 4
login authentication test
!
!
                                     RADIUS      IP  192.168.217.64
                                     RADIUS
tty 1-4                                     tty  vty

AAA                                     AAA

                                     PPP  SLIP

'  RADIUS                                     RADIUS
  RADIUS
'                                     username
```

r

configure terminal	
aaa authorization network {default list-name} group radius	RADIUS

local aaa authorization

username

configure terminal	
aaa new-model	AAA
username name privilege level	
end	
show running-config	
configure terminal	
aaa authorization network {default list-name} local	

none

none aaa authorization

configure terminal	
aaa new-model	AAA
aaa authorization network {default list-name} none	none

```
Ruijie# configure terminal
Ruijie(config)# aaa new-model
Ruijie(config)# radius-server host 192.168.217.64
Ruijie(config)# username Ruijie privilege 6
Ruijie(config)# aaa authorization network test group radius
local none
```

```
Ruijie(config)# end
Ruijie# show running-config
aaa new-model
!
aaa authorization network test group radius local none
!
username Ruijie password 0 starnet
username Ruijie privilege 6
!
radius-server host 192.168.217.64
```

AAA

RADIUS

AAA

AAA

```

aaa new-model
!
aaa accounting network acct start-stop group radius
!
username Ruijie password 0 starnet
username Ruijie privilege 6
!
radius-server host 192.168.217.64

```

```

/ :

```

VRF AAA

Virtual Private Networks (VPNs) ISP

VPN

VPN VPN routing/forwarding (VRF) table AAA

VRF

AAA VRF

configure terminal	
aaa new-model	AAA
aaa group server radius <i>gs_name</i>	RADIUS
ip vrf forwarding <i>vrf_name</i>	vrf
end	

```

/ :

```

```

vrf

```

login

Login

login

login

configure terminal	
aaa new-model	AAA
aaa local authentication attempts <1-2147483647>	login
aaa local authentication lockout-time <1-2147483647>	login
show aaa user {lockout all user-id} clear aaa local user lockout {all user-name <word>}	

RADIUS

RADIUS

RADIUS (Remote Authentication Dial-In User Service)
/ AAA
RGOS RADIUS
NAS RADIUS

RADIUS UNIX WINDOWS 2000
RADIUS RADIUS

RADIUS

/'
/' RADIUS

/' RADIUS

/' ACCEPT

/' REJECT

/' CHALLENGE RADIUS

/' ACCEPT

RADIUS

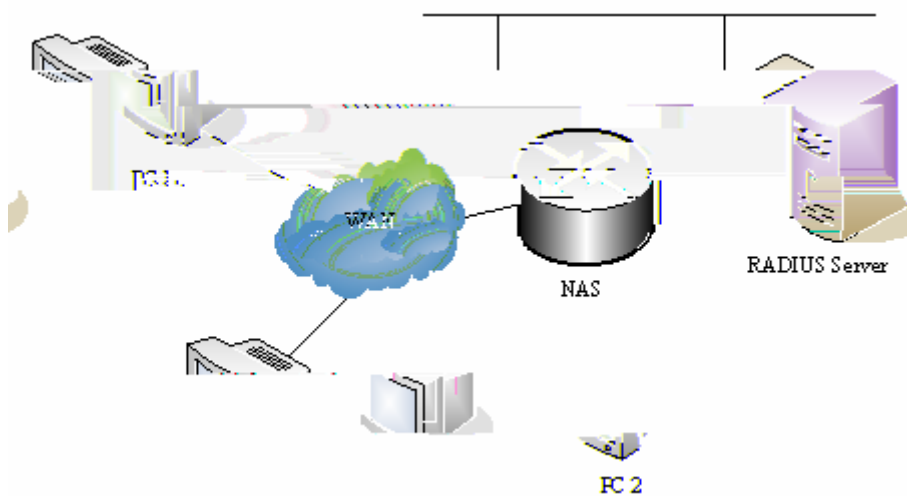

RADIUS

```

RADIUS
AAA AAA "AAA "
aaa authentication RADIUS aaa
authentication " "
RADIUS RADIUS
RADIUS
RADIUS
    
```

RADIUS

RADIUS	RADIUS	RADIUS
configure terminal		
radius-server host <i>ip-address</i> [auth-port <i>port</i>] [acct-port <i>port</i>]	IP	RADIUS
radius-server key <i>string</i>		RADIUS
radius-server retransmit <i>retries</i>		RADIUS 3
radius-server timeout <i>seconds</i>		2
radius-server deadtime <i>minutes</i>		5minutes

```

r
RADIUS RADIUS Key RADIUS
    
```

RADIUS

RADIUS RADIUS RADIUS
RADIUS RADIUS AAA
aaa authentication
RADIUS AAA

RADIUS

ID		TYPE
1	max down-rate	1
2	qos	2
3	user ip	3
4	vlan id	4
5	version to client	5
6	net ip	6
7	user name	7
8	password	8
9	file-diractory	9
10	file-count	10
11	file-name-0	11
12	file-name-1	12
13	file-name-2	13
14	file-name-3	14
15	file-name-4	15
16	max up-rate	16
17	version to server	17
18	flux-max-high32	18
19	flux-max-low32	19
20	proxy-avoid	20
21	dailup-avoid	21
22	ip privilige	22
23	login privilige	42

RADIUS

24	limit to user number	50
----	----------------------	----

ID

ID		TYPE
----	--	------

```
Ruijie# show radius vendor-specific
```

id	vendor-specific	type-value
1	max down-rate	76
2	qos	77
3	user ip	3
4	vlan id	4
5	version to client	5
6	net ip	6
7	user name	7
8	password	8
9	file-diractory	9
10	file-count	10
11	file-name-0	11
12	file-name-1	12
13	file-name-2	13
14	file-name-3	14
15	file-name-4	15
16	max up-rate	75
17	version to server	17
18	flux-max-high32	18
19	flux-max-low32	19
20	proxy-avoid	20
21	dailup-avoid	21
22	ip privilige	22
23	login privilige	42
24	limit to user number	50

```
Ruijie# configure
```

```
Ruijie(config)# radius attribute 24 vendor-type 67
```

```
Ruijie(config)# show radius vendor-specific
```

id	vendor-specific	type-value
1	max down-rate	76
2	qos	77
3	user ip	3
4	vlan id	4
5	version to client	5
6	net ip	6
7	user name	7
8	password	8
9	file-diractory	9
10	file-count	10
11	file-name-0	11
12	file-name-1	12
13	file-name-2	13

RADIUS

```
14 file-name-3 14
15 file-name-4 15
16 max up-rate 75
17 version to server 17
18 flux-max-high32 18
19 flux-max-low32 19
20 proxy-avoid 20
21 dailup-avoid 21
22 ip privilege 22
23 login privilege 42
24 limit to user number 50
Ruijie(config)#
Ruijie(config)#
```

RADIUS

RADIUS

debug radius event	RADIUS RADIUS

RADIUS

RADIUS

RADIUS

/

RADIUS Windows 2000/2003 Server IAS UNIX ,

RADIUS

```
Ruijie# configure terminal
Ruijie(config)# aaa new-model
Ruijie(config)# radius-server host 192.168.12.219
auth-port 1645 acct-port 1646
Ruijie(config)# radius-server key aaa
Ruijie(config)# aaa authentication login test group radius
Ruijie(config)# end
Ruijie# show radius server
Server IP: 192.168.12.219
```

```
Accounting Port: 1646
Authen Port:    1645
Server State:   Ready
```

```
Ruijie# configure terminal
Ruijie(config)# line vty 0
Ruijie(config-line)# login authentication test
Ruijie(config-line)# end
Ruijie# show running-config
!
aaa new-model
!
!
aaa authentication login test group radius
!
username ruijie password 0 starnet
!
radius-server host 192.168.12.219 auth-port 1645 acct-port
1646
!
line con 0
line vty 0
login authentication test
line vty 1 4
!
```

TACACS+

TACACS+

TACACS+
1

TACACS+

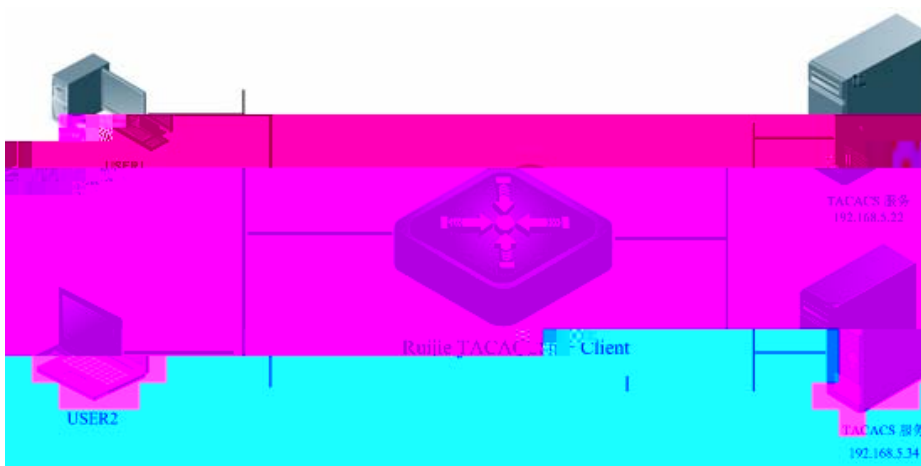

2

login

TACACS+

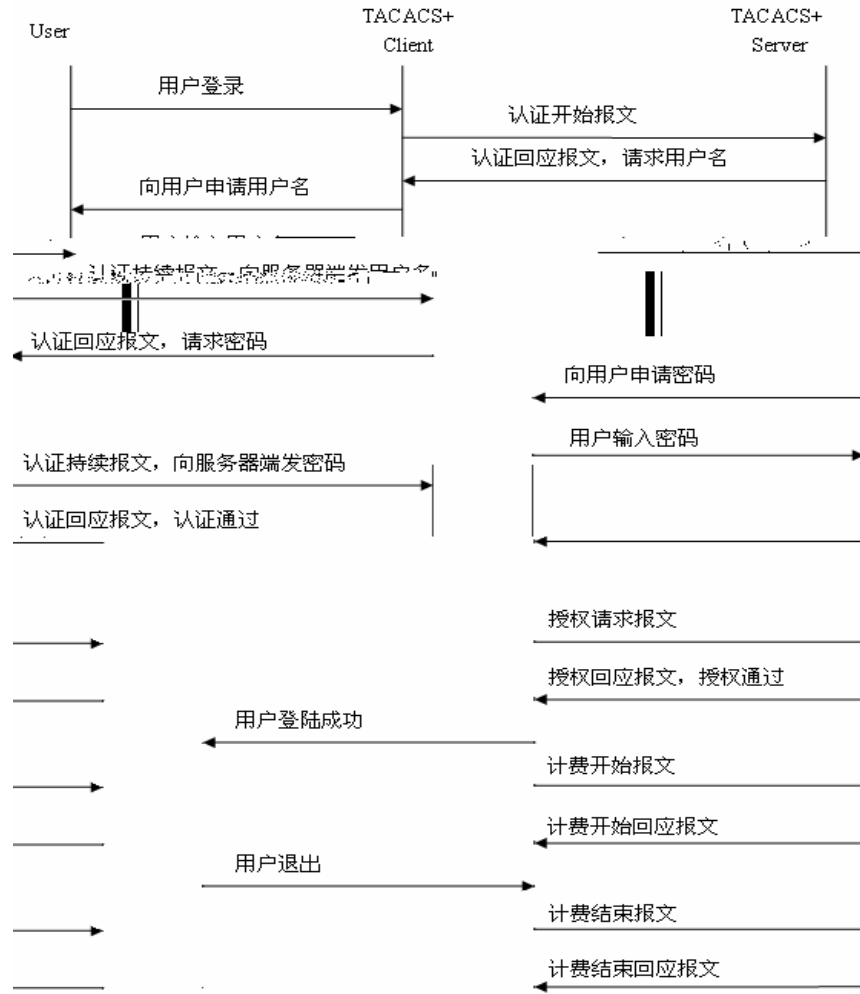

3

1.

1

2 TACACS+

TACACS+

3 TACACS+

4 TACACS+

5

6 TACACS+

TACACS+

7 TACACS+

8 TACACS+

9

10 TACACS+

TACACS+

- 11 TACACS+
- 2
- 1 TACACS+ TACACS+
- 2 TACACS+
- 3 TACACS+
- 3
- 1 TACACS+ TACACS+
- 2 TACACS+
- 3
- 4 TACACS+ TACACS+
- 5 ACACS+

TACACS+

```

TACACS+
'   aaa new-mode      AAA      TACACS+      AAA
   aaa new-mode      "AAA  "
'   tacacs-server host      tacacs+
'   tacacs-server key      NAS      key
'   tacacs-server timeout
'
   aaa authentication      TACACS+
   aaa authentication
   "      "
'
   aaa authorization      TACACS+
   aaa authorization      "
   "
'
   aaa accounting      TACACS+
   aaa accounting      "
   "
'

```

TACACS+

TACACS+ TACACS+ TACACS+ TACACS+

configure terminal	
aaa group server tacacs+ <i>group-name</i>	TACACS+ TACACS+

server

Login

TACACS+

1. aaa

```
Ruijie# configure terminal
```

```
Ruijie(config)# aaa new-model
```

2. tacacs+ server

```
Ruijie(config)# tacacs-server host 192.168.12.219 aaa new-model aaa new-model 16.017 -
```

2.

```
Ruijie(config)# tacacs-server host 192.168.12.217
Ruijie(config)# tacacs-server key aaa
```

3. tacacs+ server group

```
Ruijie(config)#aaa group server tacacs+ tacgroup1
Ruijie(config-gs-tacacs)#server 192.168.12.219
Ruijie(config-gs-tacacs)#server 192.168.12.218
```

4. tacgroup1

```
Ruijie(config)# aaa authentication enable default group
tacgroup1
```

```
enable tacacs+
```

```
Ruijie#show running-config
!
aaa new-model
!
!
aaa group server tacacs+ tacgroup1
server 192.168.12.219
server 192.168.12.218
!
aaa authentication enable default group tacgroup1
!
!
tacacs-server host 192.168.12.219
tacacs-server host 192.168.12.218
tacacs-server host 192.168.12.217
tacacs-server key aaa
!
line con 0
line vty 0
line vty 1 4
!
```

TACACS+

1. aaa

```
Ruijie# configure terminal
Ruijie(config)# aaa new-model
```

2. tacacs+ server

```
Ruijie(config)# tacacs-server host 192.168.12.219
Ruijie(config)# tacacs-server key aaa
```

```
3.          tacacs+
Ruijie(config)# aaa authorization exec test group tacacs+
```

```
4.
Ruijie(config)# line vty 0 4
Ruijie (config-line)#authorization exec test

                                tacacs+
```

```
Ruijie#show running-config
!
aaa new-model
!
!
aaa authorization exec test group tacacs+
!
tacacs-server host 192.168.12.219
tacacs-server key aaa
!
line con 0
line vty 0
  authorization exec test
line vty 1 4
  authorization exec test
!
```

15 Commans TACACS+

```
1.          aaa
Ruijie# configure terminal
Ruijie(config)# aaa new-model

2.          tacacs+ server
Ruijie(config)# tacacs-server host 192.168.12.219
Ruijie(config)# tacacs-server key aaa

3.          tacacs+
Ruijie(config)# aaa accounting commands 15 default start-stop
group tacacs+

4.
Ruijie(config)# line vty 0 4
Ruijie (config-line)#accounting commands 15 default
```

enable tacacs+

```
Ruijie#show running-config
!
aaa new-model
!
!
aaa accounting commands 15 default group tacacs+
!
!
tacacs-server host 192.168.12.219
tacacs-server key aaa
!
line con 0
line vty 0
  accounting commands 15 default
line vty 1 4
  accounting commands 15 default
!
```

SSH

SSH

SSH Secure Shell SSH Telnet
 Telnet
 SSH
 IP

SSH

	SSH1	SSH2
	RSA	RSA DSA
	RSA	KEX_DH_GEX_SHA1 KEX_DH_GRP1_SHA1 KEX_DH_GRP14_SHA1
	DES 3DES Blowfish	DES 3DES AES-128 AES-192 AES-256
		MD5 SHA1 SHA1-96 MD5-96
	NONE	NONE

SSH

r

SSH

SSHv1

SSHv2

SSH

SSH

[SSH]

SSH

SSH Windows Telnet SSH Server
 SecureCRT SSH Putty Linux SecureCRT

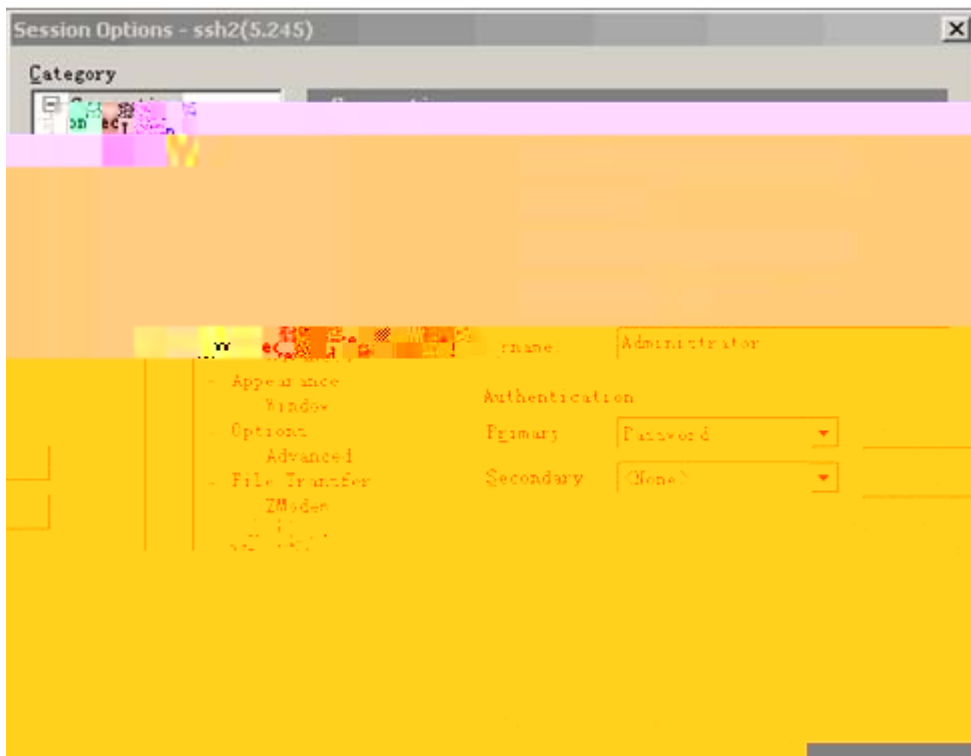

1

1	2	Protocol	SSH2	Hostname
	IP	192.168.5.245	22	SSH
	Username			
	Authentication			
	Telnet			
	OK			

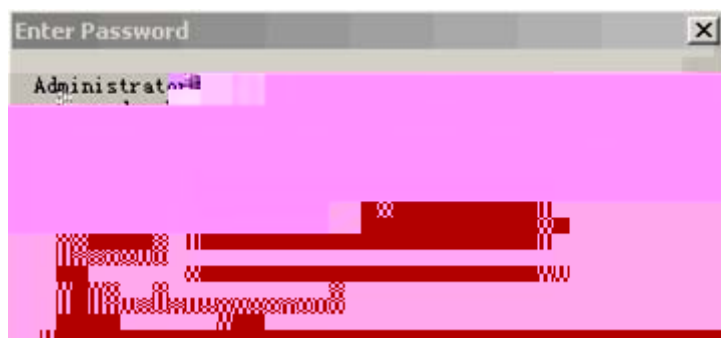

Telnet

CPU

CPU

CPU

CPU

CPU Protect

Classifying Queuing Scheduling Shaping

Classifying

Classifying
L4

CPU

L2 L3

S3760

BPDU	MAC 01-80-C2-00-00-00
ARP	ARP request
IGMP	IPV4 IGMP V1/V2/V3
802.1X	MAC 01-80-C2-00-00-03
GVRP	MAC 01-80-C2-00-00-21
DHCP	DHCP
Error_TTL	IPV4 TTL = 0 1
Unicast	MAC ARP reply, MAC snmp telnet http
Multicast	IGMP
Broadcast	DHCP

Queuing

Queuing

CPU 8

Queuing

Scheduling

Scheduling

CPU Scheduling
0

(SP) 7

6

/

S3760

CPU

CPU

CPU Protect

CPU

CPU

S3760

2	1000
1	1000
0	1000
CPU	3000

CPU Protect

```

r
S3760          GVRP  802.1X          GVRP
802.1X          GVRP          802.1X
              802.1X          GVRP

S3760          CPU          651
kbps          651(kbps)

S3760          SVI          CPU  ARP          0
              ARP
  
```



```

Ruijie(config)# cpu-protect type { bpdu | arp
| igmp | do5(it1x]TJ/TT0 1 Tf-0.0026 Tc 0.0309 Tw 6.657 0 Td< | )Tj/TT1 1 Tf-0.0006 Tc 0 Tw
  
```

bpdu 7

Ruijie(config)# cpu-protect traffic-class id <i>id_num bandwidth bandwidth_value</i>	kbps <i>id_num</i> 0 7 <i>bandwidth-value</i> 32 131072(kbps)
Ruijie(config)# cpu-protect traffic-class all bandwidth <i>bandwidth_value</i>	kbps <i>bandwidth-value</i> 32 131072(kbps)

no cpu-protect traffic-class

7 312(kbps)

```
Ruijie#configure terminal
Ruijie(config)# cpu-protect traffic-class id 7 bandwidth 312
Ruijie(config)#end
Ruijie# show cpu-protect traffic-class id 7
%*****traffic class      bandwidth(kbps)*****
          7                312
```

CPU

CPU

Ruijie(config)# cpu-protect cpu bandwidth <i>bandwidth_value</i>	CPU kbps <i>bandwidth-value</i> 64 1000000(kbps)

no cpu-protect cpu cpu

CPU 2000 kbps

```
Ruijie#configure terminal
Ruijie(config)#cpu-protect cpu bandwidth 2000
Ruijie(config)#end
Ruijie#show cpu-protect cpu
```

```
%cpu port bandwidth: 2000(kpbs)
```

CPU Protect

CPU Protect

```
,
,
,   CPU
,
,
```

Ruijie# show cpu-protect type { bpdu arp igmp dot1x gvrp dhcp unicast multicast broadcast error_ttl other }	

show cpu-protect type all

```
%*****packet type      traffic-class*****
          bpdu            6
          arp             5
          igmp            3
          dot1x           3
          gvrp            3
          dhcp            2
          unicast         4
          multicast       1
          broadcast       0
          error_ttl       0
          co-operate      6
          other           0
```

--	--

Ruijie# show cpu-protect traffic-class id <i>id_num</i>	id_num 0 7
Ruijie# show cpu-protect traffic-class all	

show cpu-protect traffic-class all

```
Ruijie# show cpu-protect traffic-class all
%*****traffic class      bandwidth(kbps)*****
          0                1000
          1                1000
          2                1000
          3                1000
          4                1000
          5                1000
          6                1000
          7                100000
```

CPU

CPU

Ruijie# show cpu-protect cpu	CPU

CPU

```
Ruijie# show cpu-protect cpu
%cpu port bandwidth: 100000(kbps)
```

configure terminal	
interface <i>interface-id</i>	interface interface
system-guard enable	
end	
show system-guard	
copy running-config startup-config	

no system-guard

IP

20"

"

configure terminal	
system-guard detect-maxnum <i>number</i>	1-500 100
end	
show system-guard	
copy running-config startup-config	

r

IP

" Chip Resource Full"

ACL

100 120 IP

no

system-guard detect-maxnum

IP

IP

IP

CPU

configure terminal	
system-guard exception-ip <i>ip mask</i>	255 IP . IP
end	
show system-guard exception-ip	IP
copy running-config startup-config	

```

no all-eip no IP
ip
Ruijie(config)# no system-guard exception-ip all-eip
ip
Ruijie(config)# no system-guard exception-ip 192.168.5.145/32

```

```

r
IP IP IP IP
system-guard IP CPU clear
S3760 IP IP 127.0.0.0

```

IP

clear system-guard [interface <i>interface-id</i> [ip-address <i>ip-address</i>]]	clear system-guard clear system-guard interface <i>interface-id</i> clear system-guard interface <i>interface-id</i> ip-address <i>ip-address</i> IP

show system-guard

show system-guard [interface <i>interface-id</i>]	

```

Ruijie# show system-guard
detect-maxnum number : 100 //
isolated host number : 11 //
interface state isolate time same-attack-pkts scan-attack-pkts
-----
Fa 0/1 ENABLE 120 20 10
Fa 0/2 DISABLE 110 21 11
.....
Ruijie# show system-guard interface Fa 0/1
detect-maxnum number : 100 //
isolated host number : 11 //
interface state isolate time same-attack-pkts scan-attack-pkts
-----
Fa 0/1 ENABLE 120 20 10

```

IP

show system-guard isolate-ip [interface interface-id]	IP IP

```

Ruijie# show system-guard isolated-ip
interface ip-address isolate reason remain-time(second)
-----
Fa 0/1 192.168.5.119 scan ip attack 110
Fa 0/1 192.168.5.109 same ip attack 61
IP IP

```



Fa 0/1 192.168.5.108 12 2

IP

IP

show system-guard exception-ip	IP

```
Ruijie# show system-guard exception-ip
Exception IP Address      Exception Mask
-----
192.168.5.145              255.255.255.0
192.168.4.11              255.255.255.0
```

GSN

GSN



r

security v3 user , SNMP v3 user

SMP

Configure terminal	
[no] security event interval <i>interval</i>	<i>interval</i> 1-65535s 5

GSN

smp server

smp sserver

show smp-server	smp server

```
Ruijie# show smp-server  
SMP-Server IP:192.168.217.220
```

security event interval

policy-map

--	--

show security event interval

C ARP (IPA, MACC). A B
A B C

DAI ARP

DAI ARP
' DAI VLAN ARP
' DHCP ARP
'
'
ARP DHCP snooping binding
DHCP snooping

ARP DAI ARP
DAI ARP

r

ip arp inspection trust, show ip arp inspection interface

ARP

DAI ARP A B C P DAI

DAI

```

DAI      ARP
          ARP

          DAI
'          VLAN  DAI
'
'          ARP
'  DHCP snooping database
    
```

VLAN DAI

```

          VLAN  DAI

          VLAN vid  DAI          vlan-id = vid  ARP
DAI          ARP

show ip arp inspection vlan          VLAN          DAI
    
```

VLAN DAI

Ruijie(config)# ip arp inspection vlan <i>vlan-id</i>	VLAN <i>vlan-id</i> DAI
Ruijie(config)# no ip arp inspection vlan [<i>vlan-id</i>]	VLAN <i>vlan-id</i> DAI <i>vlan-id</i> VLAN DAI

ARP

SVI
 ARP 15 ARP

1 ARP

show ip arp inspection interface

ARP

Ruijie(config-if)# ip arp inspection limit-rate{ <1-2048> none}	ARP / none
Ruijie(config-if)# no ip arp inspection limit-rate	

DHCP snooping database

DHCP Snooping

DHCP Snooping database ARP

DAI

VLAN DAI

VLAN

Ruijie(config)# show ip arp inspection vlan	VLAN

DAI

DAI

--	--

<pre>Ruijie(config)# show ip arp inspection interface</pre>	<p>DAI</p>
---	------------

DAI

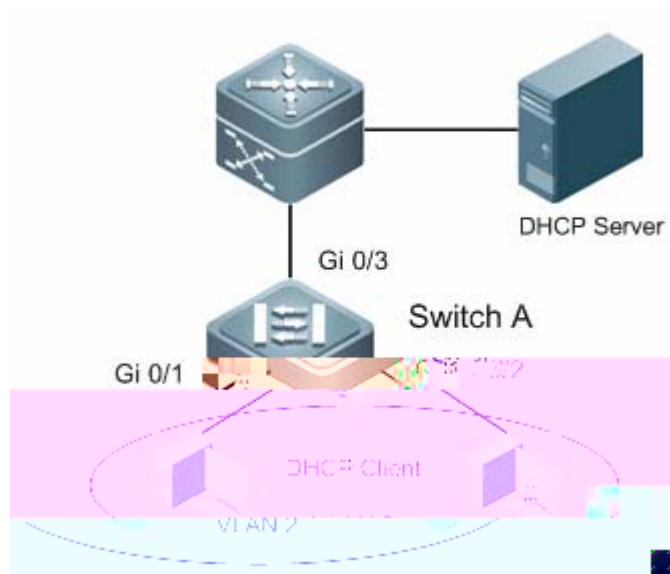

10 DHCP

	PC	IP	DHCP		
1.	PC		DHCP	IP	DHCP
2.	PC		DHCP	IP	IP

```

1.          Switch A      DHCP Snooping      DHCP
           GigabitEthernet 0/3

2.          Switch A      DHCP Snooping      DAI
',

1          PC              DHCP
   DHCP Snooping

2          Switch A
GigabitEthernet 0/3      DAI              DAI

```

Ø Switch A

PC VLAN

```

Ruijie#configure terminal
Enter configuration commands, one per line. End with CNTL/Z.
Ruijie(config)#interface range gigabitEthernet 0/1-2
Ruijie(config-if-range)#switchport access vlan 2
           DHCP SNOOPING

Ruijie(config-if-range)#exit
Ruijie(config)#ip dhcp snooping
           VLAN      DAI

Ruijie(config)#ip arp inspection vlan 2
           DHCP SNOOPING

Ruijie(config)#interface gigabitEthernet 0/3
Ruijie(config-if-GigabitEthernet 0/3)#switchport mode trunk
Ruijie(config-if-GigabitEthernet 0/3)#ip dhcp snooping trust
           DAI

Ruijie(config-if-GigabitEthernet 0/3)#ip arp inspection trust

```

DHCP Snooping/DAI

```

Ruijie#show running-config
ip dhcp snooping
!
ip arp inspection vlan 2

```

```
!  
interface GigabitEthernet 0/1  
  switchport access vlan 2  
!  
interface GigabitEthernet 0/2  
  switchport access vlan 2  
!  
interface GigabitEthernet 0/3  
  switchport mode trunk  
  ip dhcp snooping trust
```

arp

Arp

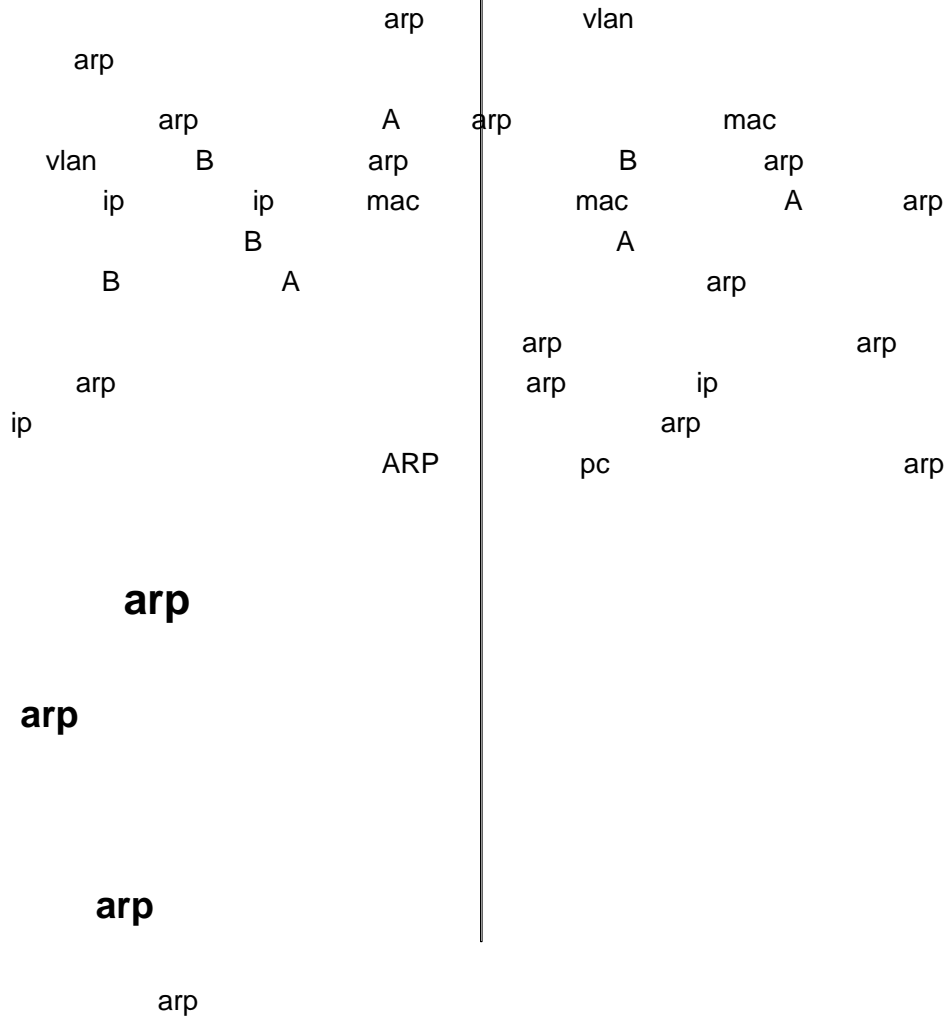

405!5BL5%

aspoofing ip, mac address

arp

arp

arp check

ipv6 acl

arp

arp

Ruijie #show anti-arp-spoofing	arp

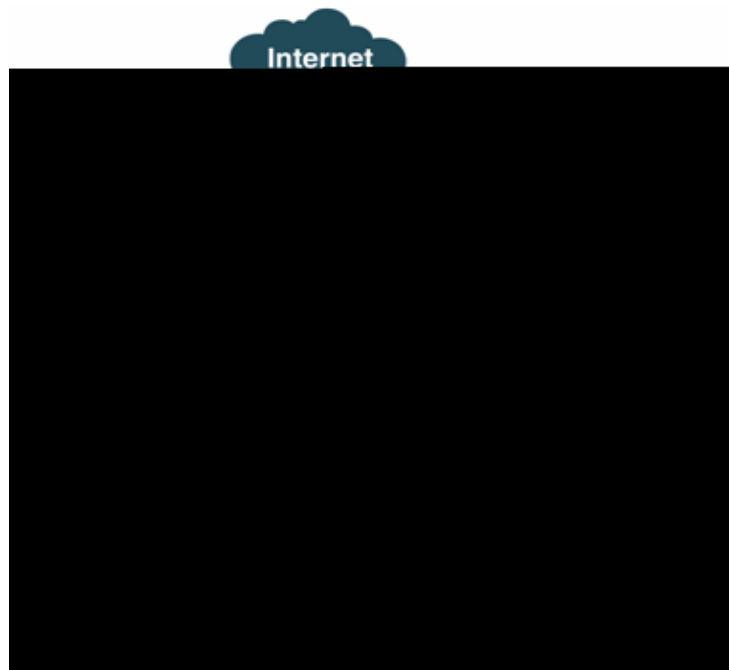

1

IP

ARP

PC

Switch A
IP

Ø

ARP

'

Switch A PC (Gi 0/3, Gi 0/4)

'

1

IP IP ARP

2

8 hub
hub

ARP

'

SwitchA

```
SwitchA# configure terminal
Enter configuration commands, one per line. End with
CNTL/Z.
SwitchA(config)#interface range gigabitEthernet 0/2-4
SwitchA(config-if-range)# anti-arp-spoofing ip
192.168.1.1
SwitchA(config-if-range)# anti-arp-spoofing ip
192.168.1.254
```

```
SwitchA (config-if)#show running-config
interface GigabitEthernet 0/1
!
interface GigabitEthernet 0/2
 anti-arp-spoofing ip 192.168.1.1
 anti-arp-spoofing ip 192.168.1.254
!
interface GigabitEthernet 0/3
 anti-arp-spoofing ip 192.168.1.1
```

```
anti-arp-spoofing ip 192.168.1.254
!  
interface GigabitEthernet 0/4  
anti-arp-spoofing ip 192.168.1.1  
anti-arp-spoofing ip 192.168.1.254  
!
```

```
SwitchA#show anti-arp-spoofing
```

```
Anti-arp-spoofing
```

port	ip		
-----	-----		
Gi 0/2	192.168.1.1		
Gi 0/2	192.168.1.254		
Gi 0/3	192.168.1.1		
Gi 0/3	192.168.1.254		
Gi 0/4	192.168.1.1		
Gi 0/4	192.168.1.254		
		PC1	IP
IP		PC2	

IP Source Guard

IP Source Guard

DHCP

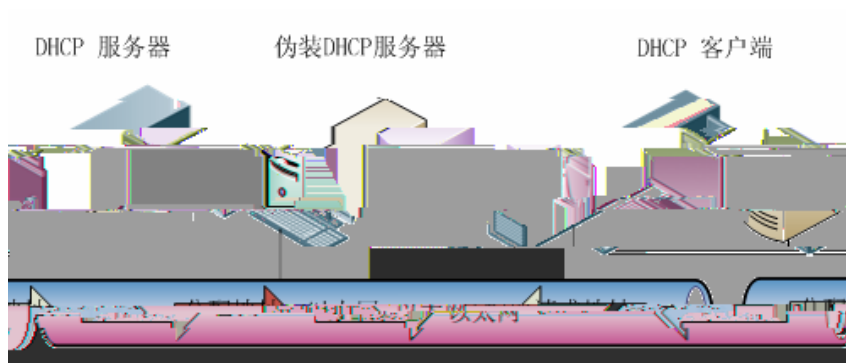
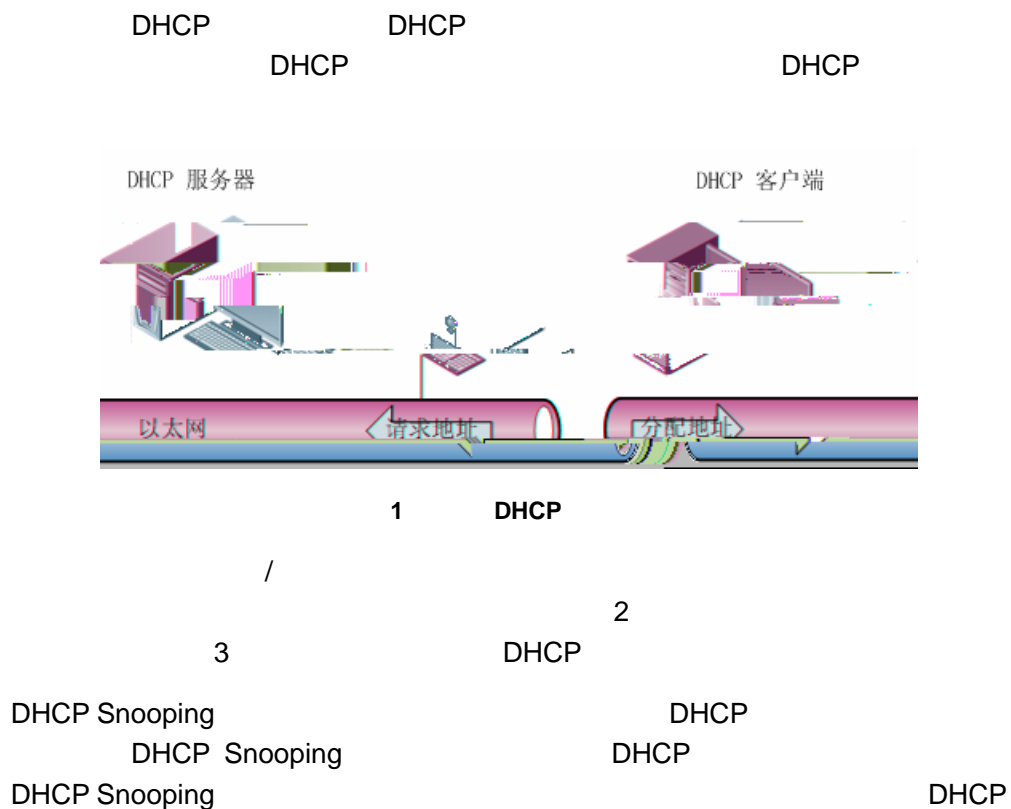

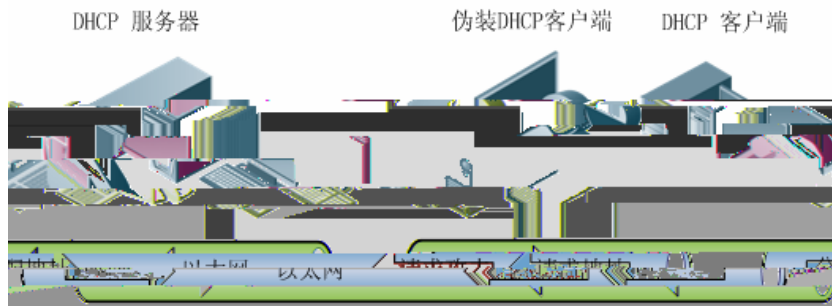

3 DHCP

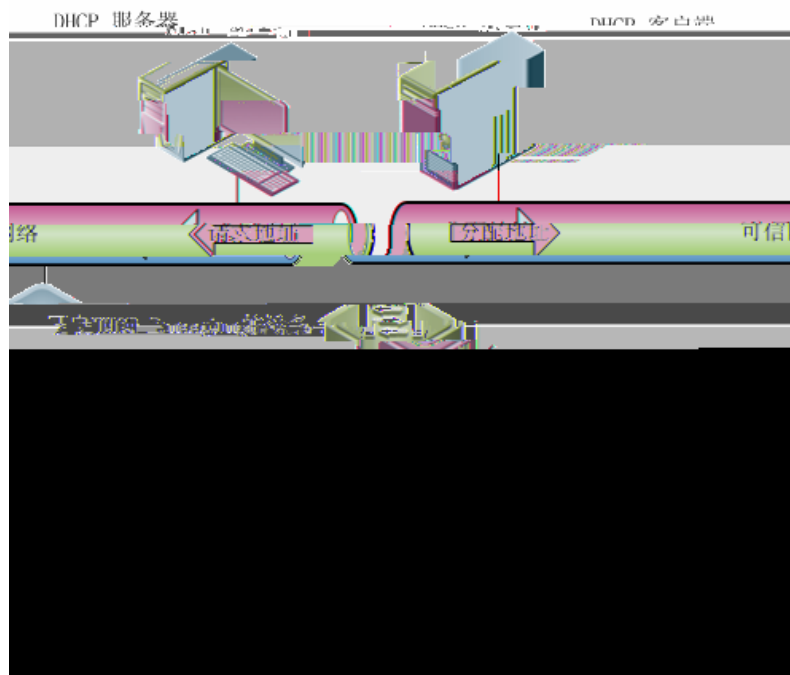

4 DHCP Snooping

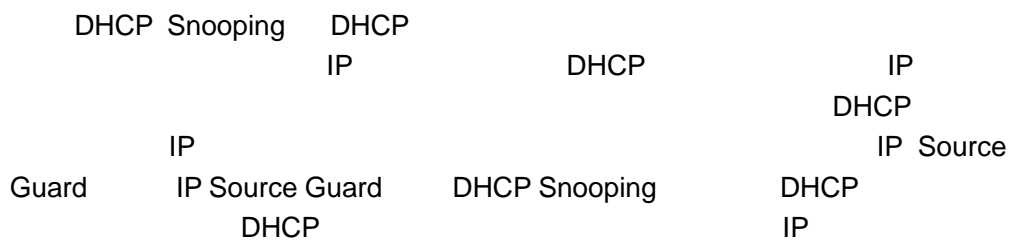

IP Source Guard

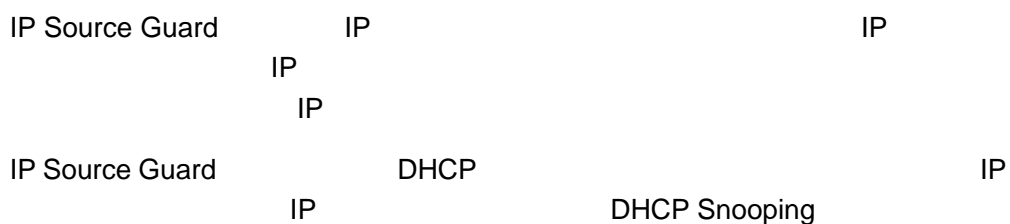

IP Source Guard DHCP Snooping IP Source
 Guard IP IP Source Guard DHCP
 Snooping IP
 IP Source Guard IP
 DHCP IP

 IP Source Guard IP + MAC IP IP
 IP + MAC IP Source Guard IP IP +
 MAC IP
 IP IP

IP Source Guard

IP Source Guard DHCP Snooping IP Source
 Guard DHCP Snooping
 DHCP Snooping VLAN

IP Source Guard

IP Source Guard

IP Source Guard
 IP Source Guard IP
 IP

Ruijie(config)# interface <i>interface-id</i>	
Ruijie(config-if)# [no] ip verify source [port-security]	IP Source Guard port-security IP IP + MAC

1 IP Source Guard

```
Ruijie(config)# interface FastEthernet 0/1
Ruijie(config-if)# ip verify source
Ruijie(config-if)# end
```

r

IP Source Guard DHCP Snooping DHCP
 Snooping

IP

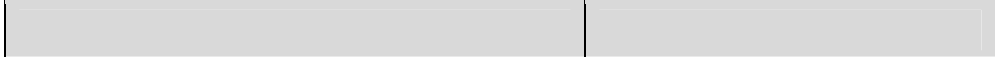

Ruijie# show ip source binding [<i>ip-address</i>] [<i>mac-address</i>] [<i>dhcp-snooping</i>] [<i>static</i>] [vlan <i>vlan-id</i>] [interface <i>interface-id</i>]	IP

```
Ruijie# show ip source binding
MacAddress   IpAddress   Lease(sec)  Type   VLAN
Interface
-----
00d0.f801.0101 192.168.4.243 infinite  static  1
FastEthernet 0/1
Total number of bindings: 1
```

IP Source Guard

IP Source Guard

Ruijie# debug ip source bind	/ IP Source Guard

```
Ruijie# debug ip source bind
```

IP Source Guard

Ø **Switich A****DHCP Snooping**

```
Ruijie#configure terminal
Enter configuration commands, one per line. End with CNTL/Z.
Ruijie(config)#ip dhcp snooping
```

DHCP SNOOPING

```
Ruijie(config)#interface gigabitEthernet 0/1
Ruijie(config-if-GigabitEthernet 0/1)#ip dhcp snooping trust
Ruijie(config-if-GigabitEthernet 0/1)#exit
```

PC**IP Source Guard**

```
Ruijie(config)#interface range gigabitEthernet 0/2-3
Ruijie(config-if-range)#ip verify source port-security
Ruijie(config-if-range)#exit
```

```
Ruijie(config)#ip source binding 0000.0000.0001 vlan 1
192.168.216.4 interface gigabitEthernet 0/2
```

Switch A**DHCP Snooping
IP Source Guard**

```
Ruijie#show running-config
ip dhcp snooping
!
ip source binding 0000.0000.0001 vlan 1 192.168.216.1 interface
GigabitEthernet 0/2
!
interface GigabitEthernet 0/1
  ip dhcp snooping trust
!
interface GigabitEthernet 0/2
  ip verify source port-security
!
interface GigabitEthernet 0/3
  ip verify source port-security
```

DHCP Snooping

```
Ruijie#show ip dhcp snooping binding
Total number of bindings: 2
```

```

MacAddress      IpAddress      Lease(sec)    Type          VLAN
Interface
-----
0013.2049.9014  192.168.216.4  86233         dhcp-snooping 1
GigabitEthernet 0/3
00e0.4c70.b7e2  192.168.216.3  86228         dhcp-snooping 1
GigabitEthernet 0/2

```

DHCP Snooping

IP

Ruijie#show ip source binding

```

MacAddress      IpAddress      Lease(sec)    Type          VLAN
Interface
-----
0000.0000.0001  192.168.216.4  infinite      static        1
GigabitEthernet 0/2
0013.2049.9014  192.168.216.4  86176         dhcp-snooping 1
GigabitEthernet 0/3
00e0.4c70.b7e2  192.168.216.3  86171         dhcp-snooping 1
GigabitEthernet 0/2

```

Total number of bindings: 3

IP Source Guard

Ruijie#show ip verify source

```

Interface      Filter-type  Filter-mode  Ip-address
Mac-address    VLAN
-----
GigabitEthernet 0/2 ip+mac      active      192.168.216.4
0000.0000.0001 1
GigabitEthernet 0/2 ip+mac      active      192.168.216.3
00e0.4c70.b7e2 1
GigabitEthernet 0/2 ip+mac      active      deny-all
deny-all
GigabitEthernet 0/3 ip+mac      active      192.168.216.4
0013.2049.9014 1
GigabitEthernet 0/3 ip+mac      active      deny-all
deny-all

```

- ' IP
- ' IP
- ' MAC
- ' MAC
- ' Expert
- ' IPV6

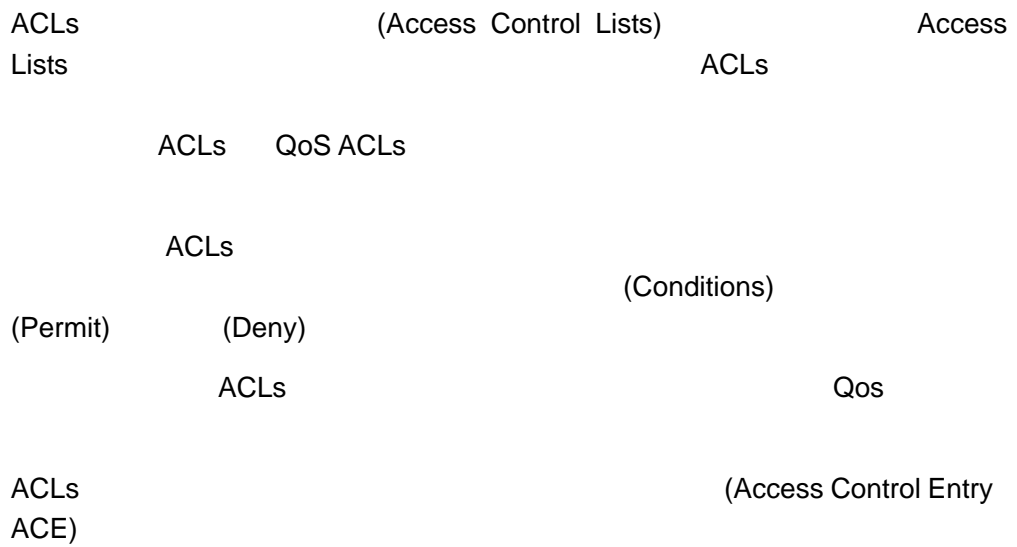

WWW

TELNET

1

A

B

1

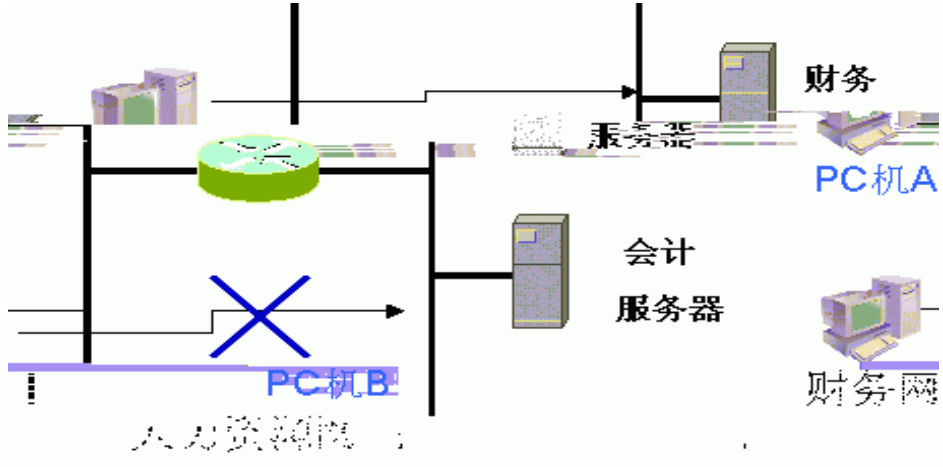

1

IPSEC

INTERNET

/ ACL

ACL ACE
ACL ACE
ACL ACE
(Permit Deny) ACL ACE
(Layer 2 Fields)
' 48 MAC (48)
' 48 MAC (48)
' 16
(Layer 3 Fields)
' IP (IP

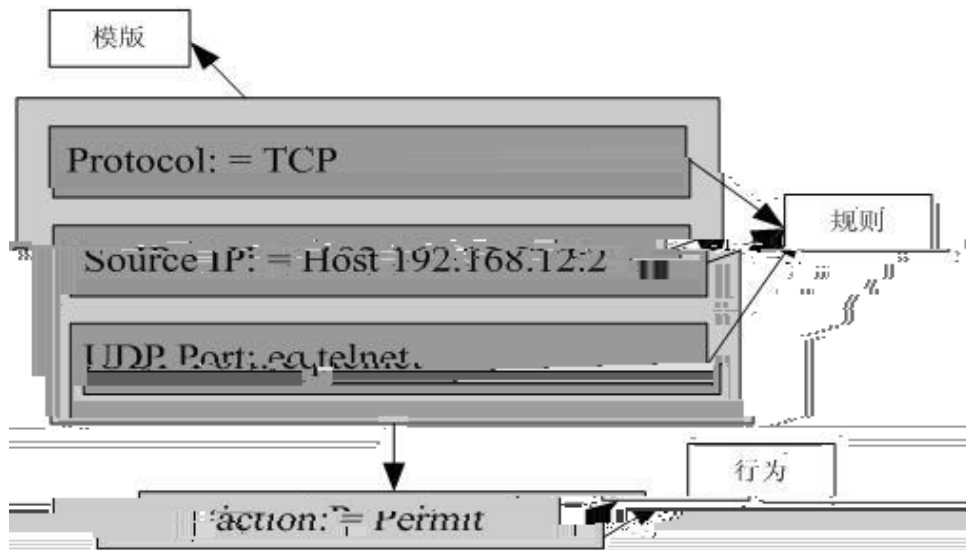

2 ACE permit tcp host 192.168.12.2 any eq telnet

/

(Layer 3 Field)
(Layer 2 Field)

(Layer 4 Field)
ACL

Expert

Expert ACLs

IP

IP	1-99 1300 - 1999
IP	100-199 2000 - 2699

IP

‘
‘
‘
‘

IP 1 - 99 1300 - 1999 IP
 IP 100 – 199 2000 - 2699

“

”

“

”

access-list 1 permit host 192.168.4.12

192.168.4.12

access-list 1 deny any

192.168.4.16

```
access-list 101 deny ip any any
access-list 101 permit tcp 192.168.12.0 0.0.0.255 eq telnet
any
```

IP 192.168.12.0/24

Telnet

IP

- 1.
- 2.



```
Ruijie(config)# access-list id {deny | permit}
{src src-wildcard | host src | any } [time-range
tm-rng-name]
```

Ruijie(config-if)# ip access-group <i>id { in out }</i>	
---	--

/

ACL
(ACE) ACL

IP

show access-lists [*id | name*]

IP

1. 192.168.12.0/24

UNIX

TELNET PING

2. Switch B

192.168.202.0/24

/

Switch B

```
Ruijie(config)# interface GigabitEthernet 0/1
Ruijie(config-if)# ip address 192.168.12.1 255.255.255.0
Ruijie(config-if)# exit
Ruijie(config)# interface GigabitEthernet 0/2
Ruijie(config-if)# ip address 2.2.2.2 255.255.255.0
Ruijie(config-if)# ip access-group 101 in
Ruijie(config-if)# ip access-group 101 out

101

Ruijie(config)# access-list 101 permit tcp 192.168.12.0
0.0.0.255 any eq telnet time-range check
Ruijie(config)# access-list 101 deny icmp 192.168.12.0
0.0.0.255 any
Ruijie(config)# access-list 101 deny ip 2.2.2.0 0.0.0.255 any
Ruijie(config)# access-list 101 deny ip any any
```

Time-Range

```
Ruijie(config)# time-range check
Ruijie(config-time-range)# periodic weekdays 8:30 to 17:30
```

/

101

access-list 101 deny ip any any

Switch A

```
Ruijie(config)# hostname Ruijie
Ruijie(config)# interface GigabitEthernet 0/1
Ruijie(config-if)# ip address 192.168.202.1 255.255.255.0
Ruijie(config)# interface GigabitEthernet 0/2
Ruijie(config-if)# ip address 2.2.2.1 255.255.255.0
```

MAC

MAC

MAC



```

ACL
( [sn] )
-E expert ACL OUT IP
ACE

```

Expert

```
show access-lists [id | name]
```

```
Expert
```

Expert

```
Expert
```

```

1. VLAN20 0013.2049.8272 Giga 0/1
2.
Ruijie> enable
Ruijie# config terminal
Ruijie(config)# expert access-list extended expert-list
Ruijie(config-exp-nacl)# permit ip vid 20 any host
0013.2049.8272 any any
Ruijie(config-exp-nacl)# deny any any any any
Ruijie(config-exp-nacl)# exit
Ruijie(config)# interface gigabitEthernet 0/1
Ruijie(config-if)# expert access-group expert-list in
Ruijie(config-if)# end
Ruijie# show access-lists
expert access-list extended expert-list
petmit ip vid 20 any host 0013.2049.8272 any any
deny any any
Ruijie#

```

IPv6

IPv6

IPv6

1. IPv6
2. ()

ACL

Ruijie(config)# ipv6 access-list <i>name</i>	
Ruijie (config-ipv6-nacl)# [<i>sn</i>] { permit deny } <i>prot</i> { <i>src-ipv6-prefix/prefix-len</i> host <i>src-ipv6-addr</i> any } { <i>dst-ipv6-pfix/pfix-len</i> any host <i>dst-ipv6-addr</i> } [dscp <i>dscp</i>] [flow-label <i>flow-label</i>] [fragments] [time-range <i>tm-rng-name</i>]	ACL ,
Ruijie(config-exp-nacl)# exit Ruijie(config)# interface <i>interface</i>	
Ruijie(config-if)# ipv6 traffic-filter <i>name in</i>	

IPv6

Ruijie# **show access-lists** [*name*]

IPv6

1. 192.168.4.12 gi 0/1
- 2.

Ruijie> **enable**

Ruijie# **config terminal**

Ruijie(config)# **ipv6 access-list** *v6-list*

```

Ruijie(config-ipv6-nacl)# permit ipv6 ::192:68:4:12/24 any
Ruijie(config-ipv6-nacl)# deny ipv6 any any
Ruijie(config-ipv6-nacl)# exit
Ruijie(config)# interface gigabitEthernet 0/1
Ruijie(config-if)# ipv6 traffic-filter v6-list in
Ruijie(config-if)# end
Ruijie# show access-lists
ipv6 access-list extended v6-list
petmit ipv6 ::192.168.4.12 any
deny any any
Ruijie#

```

TCP Flag

```

TCP Flag
          TCP Flag
          ACL
          TCP Flag
          Match-All
          TCP Flag
          TCP Flag

```

permit tcp any any match-all rst

TCP Flag RST 0

/

```

          ACL
          ACL
          TCP
MAC      IP
          TCP Flag

```

Ruijie(config)# ip access-list extended { id name }	
Ruijie(config-ext-nacl)# [sn] [permit deny] tcp source source-wildcard [operator port [port]] destination destination-wildcard [operator port [port]] [match-all flag-name][precedence precedence]	ACL ,

Ruijie(config-exp-nacl)#

Ruijie(config-if)# **ip access-group**

ip access-list resequence {acl-id| acl-name} sn-start sn-inc

	ACL list	ace	tst_acl	ACL
ace				

ace1: 10

ace2: 20

ace3: 30

ip access-list resequence *tst_acl 100 3*, ACE
Ruijie(config)#

Time-Range

Ruijie# configure terminal	
Ruijie(config)# time-range <i>time-range-name</i>	
Ruijie(config-time-range)# absolute [start time date] end time date	() time range
Ruijie(config-time-range)# periodic <i>day-of-the-week time to [day-of-the-week] time</i>	() time range
Ruijie# show time-range	
Ruijie# copy running-config startup-config	
Ruijie(config)# ip access-list extended 101	ACL
Ruijie(config-ext-nacl)# permit ip any any time-range <i>time-range-name</i>	ACE

/

Time Range 1 32

Time Range

Time Range

ACL

HTTP

```
Ruijie(config)# time-range no-http
Ruijie(config-time-range)# periodic weekdays 8:00 to 18:00
Ruijie(config)# end
Ruijie(config)# ip access-list extended limit-udp
Ruijie(config-ext-nacl)# deny tcp any any eq www time-range no-http
Ruijie(config-ext-nacl)# exit
Ruijie(config)# interface gigabitEthernet 0/1
Ruijie(config-if)# ip access-group no-http in
Ruijie(config)# end
```

Time Range :

```

Ruijie# show time-range
time-range entry: no-http(inactive)
periodic Weekdays 8:00 to 18:00
time-range entry: no-udp
periodic Tuesday 15:30 to 16:30

```

TCP

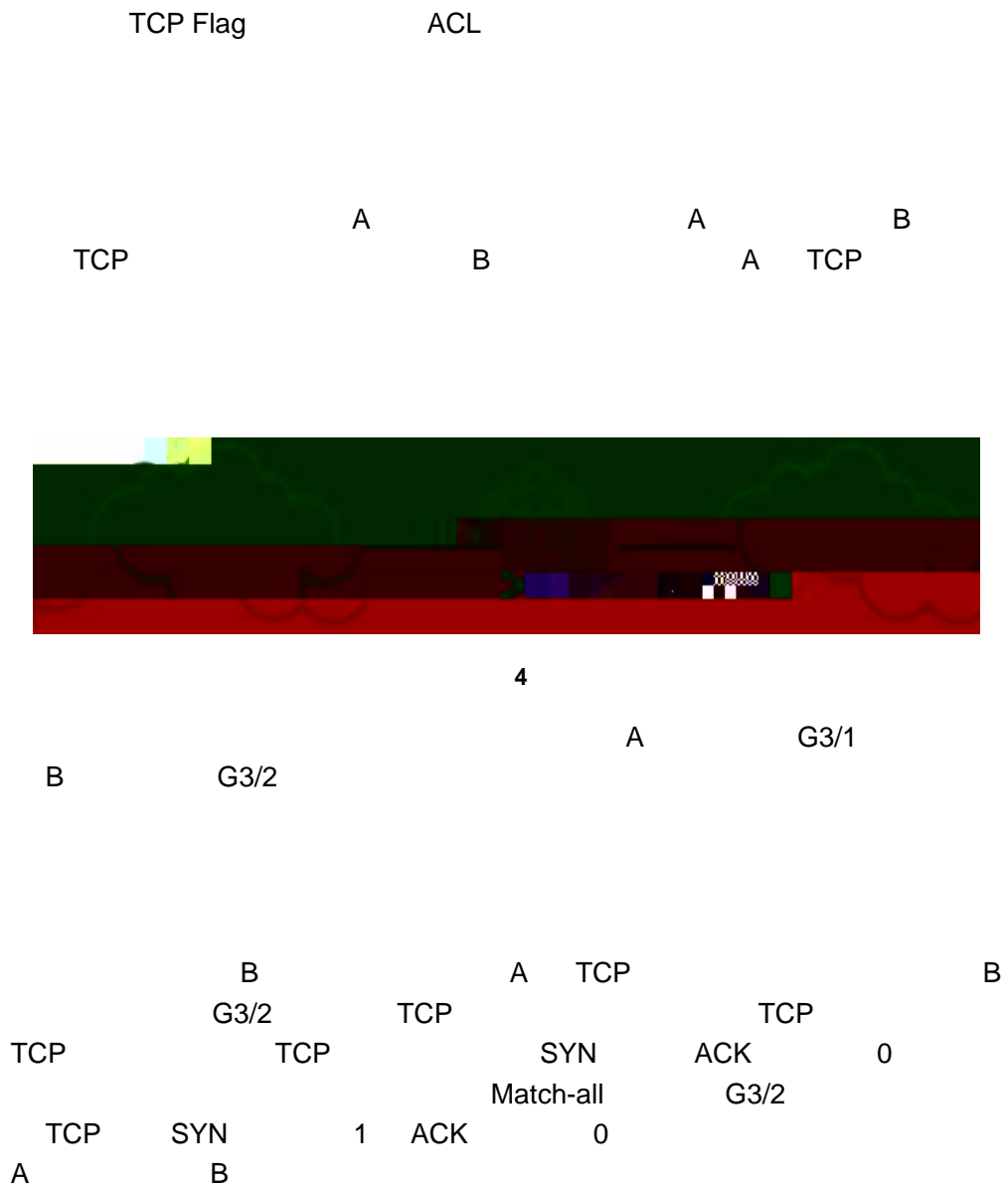

1)

```
#
Ruijie# configure terminal
#
ACL101
Ruijie(config)# ip access-list extended 101
#   TCP Flag  SYN=1          ACK          0
Ruijie(config-ext-nacl)# deny tcp any any match-all syn
#   IP
Ruijie(config-ext-nacl)# permit ip any any
2)
#
Ruijie(config-ext-nacl)# exit
#
G3/2
Ruijie(config)# interface gigabitEthernet 3/2
#   ACL 101      G3/2
Ruijie(config-if)# ip access-group 101 in
3)
#
show      ACL
Ruijie# show access-lists 101
ip access-list extended 101
10 deny tcp any any match-all syn
20 permit ip any any
```

ACL



1 ACL

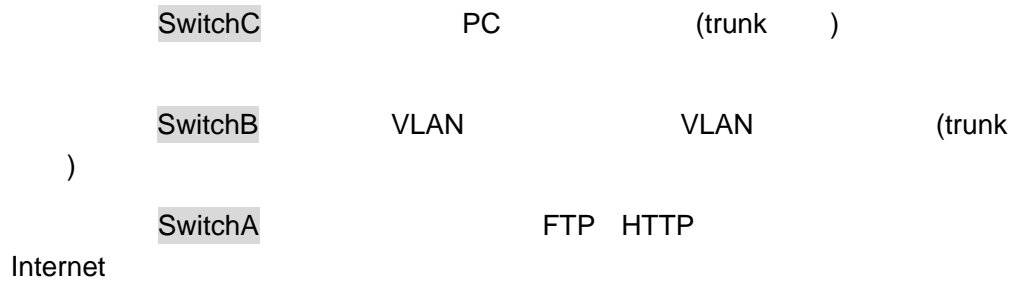

ACL

1 Internet
 2 PC PC
 3 PC PC PC PC
 4 9:00~18:00 QQ MSN

1. SwitchA Router G2/1
 ACL
 2. PC PC
 IP ACL SwitchA
 G2/2 /SVI 2
 3. SwitchB G0/22 G0/23 IP IP ACL
 ACL
 4. IP ACL QQ/MSN
 SwitchB SVI2 IP ACL

SwitchA

Virus_Defence

```

          udp/69          tftp
                          IP
                          TCP 136
445 593 1025 5554 9995 9996 UDP 136 445 593 1433
1434 UDP/TCP 135 137 138 139
          TCP/4444
          tftp
  
```

```

SwitchA#configure terminal
SwitchA(config)#ip access-list extended Virus_Defence
!
SwitchA(config-ext-nacl)#deny tcp any any eq 135
  
```

```
SwitchA(config-ext-nacl)#deny tcp any eq 135 any
SwitchA(config-ext-nacl)#deny tcp any any eq 136
SwitchA(config-ext-nacl)#deny tcp any eq 136 any
SwitchA(config-ext-nacl)#deny tcp any any eq 137
SwitchA(config-ext-nacl)#deny tcp any eq 137 any
.....!
SwitchA(config-ext-nacl)#deny tcp any any eq 9996
SwitchA(config-ext-nacl)#deny tcp any eq 9996 any

!                               UDP
SwitchA(config-ext-nacl)#deny udp any any eq 69
SwitchA(config-ext-nacl)#deny udp any eq 69 any
SwitchA(config-ext-nacl)#deny udp any any eq 135
SwitchA(config-ext-nacl)#deny udp any eq 135 any
SwitchA(config-ext-nacl)#deny udp any any eq 137
SwitchA(config-ext-nacl)#deny udp any eq 137 any
.....!
SwitchA(config-ext-nacl)#deny udp any any eq 1434
SwitchA(config-ext-nacl)#deny udp any eq 1434 any

!    ICMP
SwitchA(config-ext-nacl)#deny icmp any any

!           ip
SwitchA(config-ext-nacl)#permit ip any any

SwitchA(config-ext-nacl)#exit
```

Virus_Defence

Router

```
SwitchA(config)#interface gigabitEthernet 2/1
SwitchA(config-if)#no switchport
SwitchA(config-if)#ip address 192.168.5.1 255.255.255.0

!    ACL Virus_Defence      G2/1
SwitchA(config-if)#ip access-group Virus_Defence in

SwitchA(config-if)#exit
```

access_server

192.168.2.0 0.0.0.255

SwitchB(config-ext-nacl)#permit ip any any
SwitchB(config-ext-nacl)#exit

(vlan_access1 vlan_access2)

! G0/22 trunk vlan_access1

SwitchB(config)#interface GigabitEthernet 0/22
SwitchB(config-if)#switchport mode trunk
SwitchB(config-if)#ip access-group vlan_access1 in

! G0/23 trunk vlan_access2

SwitchB(config)# interface GigabitEthernet 0/23
SwitchB(config-if)# switchport mode trunk
SwitchB(config-if)# ip access-group vlan_access2 in

! G0/24 trunk

SwitchB(config)#interface GigabitEthernet 0/24
SwitchB(config-if)#switchport mode trunk

! SVI2 IP

SwitchB(config)#interface vlan 2
SwitchB(config-if)#ip address 192.168.1.100 255.255.255.0

! SVI3 IP

SwitchB(config)#interface vlan 3
SwitchB(config-if)#ip address 192.168.2.100 255.255.255.0

! SVI4 IP

SwitchB(config)#interface vlan 4
SwitchB(config-if)#ip address 192.168.4.1 255.255.255.0

! 9 0018

```
SwitchB(config-ext-nacl)#deny tcp 192.168.1.0 0.0.0.255 eq 443
any time-range worktime
SwitchB(config-ext-nacl)#deny tcp 192.168.1.0 0.0.0.255 eq
1863 any time-range worktime
SwitchB(config-ext-nacl)#deny tcp 192.168.1.0 0.0.0.255 eq
4000 any time-range worktime
SwitchB(config-ext-nacl)#deny udp 192.168.1.0 0.0.0.255 eq
8000 any time-range worktime
SwitchB(config-ext-nacl)#deny udp 192.168.1.0 0.0.0.255 eq
1429 any time-range worktime
SwitchB(config-ext-nacl)#deny udp 192.168.1.0 0.0.0.255 eq
6000 any time-range worktime
SwitchB(config-ext-nacl)#deny udp 192.168.1.0 0.0.0.255 eq
6001 any time-range worktime
SwitchB(config-ext-nacl)#deny udp 192.168.1.0 0.0.0.255 eq
6002 any time-range worktime
SwitchB(config-ext-nacl)#deny udp 192.168.1.0 0.0.0.255 eq
6003 any time-range worktime
SwitchB(config-ext-nacl)#deny udp 192.168.1.0 0.0.0.255 eq
6004 any time-range worktime
```

```
! IP
```

```
SwitchB(config-ext-nacl)#permit ip any any
```

```
! SVI2
```

```
SwitchB(config)#interface vlan 2
```

```
SwitchB(config-if)#ip access-group yanfa in
```

ACE

```
SwitchA#show access-lists
```

```
ip access-list extended Virus_Defence
```

```
10 deny tcp any any eq 135
```

```
20 deny tcp any eq 135 any
```

```
30 deny tcp any eq 4444 any
```

```
40 deny tcp any any eq 5554
```

```
50 deny tcp any eq 5554 any
```

```
60 deny tcp any any eq 9995
```

```
70 deny tcp any eq 9995 any
```

```
80 deny tcp any any eq 9996
```

```
90 deny tcp any eq 9996 any
```

```
100 deny udp any any eq tftp
```

```
110 deny udp any eq tftp any
```

```
120 deny udp any any eq 135
130 deny udp any eq 135 any
140 deny udp any any eq netbios-ns
150 deny udp any eq netbios-ns any
160 deny udp any any eq netbios-dgm
170 deny udp any eq netbios-dgm any
180 deny udp any any eq netbios-ss
190 deny udp any eq netbios-ss any
200 deny udp any any eq 445
210 deny udp any eq 445 any
220 deny udp any any eq 593
230 deny udp any eq 593 any
240 deny udp any any eq 1433
250 deny udp any eq 1433 any
260 deny udp any any eq 1434
270 deny udp any eq 1434 any
280 deny tcp any any eq 136
290 deny tcp any eq 136 any
300 deny tcp any any eq 137
310 deny tcp any eq 137 any
320 deny tcp any any eq 138
330 deny tcp any eq 138 any
340 deny tcp any any eq 139
350 deny tcp any eq 139 any
360 deny tcp any any eq 445
370 deny tcp any eq 445 any
380 deny tcp any any eq 593
390 deny tcp any eq 593 any
400 deny tcp any eq 1025 any
410 deny tcp any any eq 4444
420 deny icmp any any
430 permit tcp any any
440 permit udp any any
450 permit ip any any
```

```
ip access-list extended access_server
```

```
10 permit ip 192.168.2.0 0.0.0.255 host 192.168.4.100
20 permit ip 192.168.1.0 0.0.0.255 host 192.168.4.100
30 permit ip 192.168.3.0 0.0.0.255 host 192.168.4.100
40 deny ip any any
```

```
SwitchB#show access-lists
```

```
ip access-list extended vlan_access1
```

```
10 deny ip 192.168.2.0 0.0.0.255 192.168.1.0 0.0.0.255
20 deny ip 192.168.3.0 0.0.0.255 192.168.1.0 0.0.0.255
30 permit ip any any
```

```
ip access-list extended vlan_access2
 10 deny ip 192.168.1.0 0.0.0.255 192.168.2.0 0.0.0.255
 20 deny ip 192.168.3.0 0.0.0.255 192.168.2.0 0.0.0.255
 30 permit ip any any

ip access-list extended yanfa
 10 deny tcp 192.168.1.0 0.0.0.255 eq 8000 any time-range
worktime (active)
 20 deny tcp 192.168.1.0 0.0.0.255 eq 8001 any time-range
worktime (active)
 30 deny tcp 192.168.1.0 0.0.0.255 eq 443 any time-range
worktime (active)
 40 deny tcp 192.168.1.0 0.0.0.255 eq 1863 any time-range
worktime (active)
 50 deny tcp 192.168.1.0 0.0.0.255 eq 4000 any time-range
worktime (active)
 60 deny udp 192.168.1.0 0.0.0.255 eq 8000 any time-range
worktime (active)
 70 deny udp 192.168.1.0 0.0.0.255 eq 1429 any time-range
worktime (active)
 80 deny udp 192.168.1.0 0.0.0.255 eq 6000 any time-range
worktime (active)
 90 deny udp 192.168.1.0 0.0.0.255 eq 6001 any time-range
worktime (active)
100 deny udp 192.168.1.0 0.0.0.255 eq 6002 any time-range
worktime (active)
110 deny udp 192.168.1.0 0.0.0.255 eq 6003 any time-range
worktime (active)
120 deny udp 192.168.1.0 0.0.0.255 eq 6004 any time-range
worktime (active)
```

ACL

ACL

SwitchA

```
SwitchA#show run
interface GigabitEthernet 2/1
 no switchport
 no ip proxy-arp
 ip access-group Virus_Defence in
 ip address 192.168.5.1 255.255.255.0
!
interface GigabitEthernet 2/2
 switchport mode trunk
 ip access-group access_server in
```



ACL&ACL80

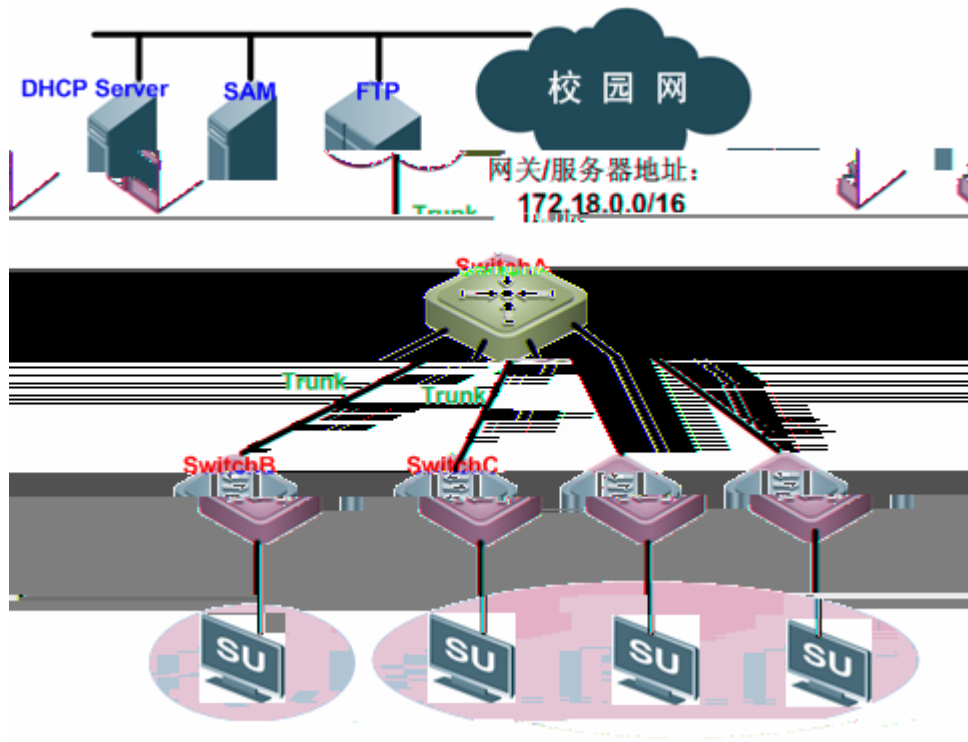

2 ACL&ACL80

SwitchA		VLAN		VLAN
(trunk)				
SwitchB	SwitchC		PC	(trunk)
PC	SU	802.1x		
SU	windows	PC		SU
	PC	802.1x		
1)	/	172.18.0.0/16	IP	ARP
		PC		
2)	DHCP	(UDP 67/68)	PC	IP



SwitchB/SwitchC ACL80 ACL

SwitchB ACL80 SwitchC ACL

SwitchB

bit 80 64

1



```
SwitchC(config)#expert access-list extended tongdao1
!      IP 172.18.0.0      IP
SwitchC(config-exp-dacl)#permit ip 172.18.0.0 0.0.255.255 any
any any
!      udp      67 Bootstrap Protocol Server 68 Bootstrap Protocol
Client
SwitchC(config-exp-dacl)#permit udp any any eq bootpc any any
eq bootps
SwitchC(config-exp-dacl)#exit
```

ACL

```
!      ACL tongdao1
SwitchC(config)# security global access-group tongdao1
```

ACE

```
SwitchB# show access-lists
expert access-list advanced tongdao
 10 permit 0806 FFFF 24 AC12 FFFF 40
 20 permit 0800 FFFF 24 AC12 FFFF 38
 30 permit 11 FF 35 00440043 FFFFFFFF 46
SwitchC# show access-lists
expert access-list extended tongdao1
 10 permit ip 172.18.0.0 0.0.255.255 any any any
 20 permit udp any any eq bootpc any any eq bootps
```

ACE

ACL

ACL

```
SwitchB#show run
expert access-list advanced tongdao
!
security global access-group tongdao
!
SwitchC#show run
!
expert access-list advanced tongdao1
!
security global access-group tongdao1
!
```

/

3 2 1

2 1

ACLs

QoS

2 1

QoS
DSCP

QoS

QoS QoS QoS ACLs QoS Trust
DSCP QoS Trust DSCP IP

Queueing

Queueing
Cos-to-Queue Map 8 DSCP DSCP-to-CoS Map

Scheduling

Scheduling QoS WRR 8
WRR , DRR ,

buffer

802.3x flow-control
flow-control QoS HOL
802.3xflow-control
QoS HOL
flow-control ()
Pause
QoS
Pause

100m 100m QoS 1000m
FC
QoS QoS QoS
flow-control
Police (QoS) buffer
QoS flow-control

QoS

QoS AP
Policy-map QoS
Policy-map
r
Aggregate Port
128

QoS

QoS

QoS QoS
' 1 Policy-map
' Policy-map Class-map
' Class-map 1 ACL ACL ACE
' ACE " ACL"
QoS
Policy Map QoS
QoS Off QoS Policy Map

CoS	0
-----	---

	8
	WRR
QueueWeight	1:1:1:1:1:1:1
WRR Weight Range	1:15
DRR Weight Range	1:15
	No Trust

CoS

CoS 0 1 2 3 4 5 6 7

```
Ruijie# configure terminal  
Ruijie(config)# interface gigabitEthernet 0/1  
Ruijie(config-if-range)# virtual-group 5  
Ruijie(config-if-range)# end
```

Class Maps

Policy Maps

Policy Maps

configure terminal	
[no] policy-map <i>policy-map-name</i>	<pre> policy-map policy-map-name policy-map no map policy </pre>

[no] class *class-map-name*

```

class-map-name
class
map
no

```

WRR SP DRR
 WRR)
 , QOS

configure terminal	
mls qos scheduler {sp wrr drr }	sp wrr drr
no mls qos scheduler	wrr

SP

```
Ruijie# configure terminal
Ruijie(config)# mls qos scheduler sp
Ruijie(config)# end
Ruijie# show mls qos scheduler
Global Multi-Layer Switching scheduling
Strict Priority
Ruijie#
```

/

```
S3760          SP+DRR          SP+DRR          SP DRR
                DRR          DRR          DRR
                1 2 3 4          1 3 4          DRR
```

--	--

	configure terminal	
weight1...weightn	{wrr-queue} bandwidth	weight1...weightn
	no {wrr-queue } bandwidth	no

```

Ruijie#
Ruijieconfig)#                               1 2 3 4 5 6 7 8
Ruijieconfig)#
Ruijie#

```

Cos-Map

Cos-Map

Cos-Map

<pre> mls qos map cos-dscp dscp1...dscp8 no mls qos map cos-dscp </pre>	<pre> CoS-to-DSCP Map ,dscp1...dscp8 CoS 0 7 DSCP ,DSCP </pre>
---	---

```

Ruijie# configure terminal
Ruijie(config)# mls qos map cos-dscp 56 48 46 40 34 32 26 24
Ruijie(config)# end
Ruijie# show mls qos maps cos-dscp
cos dscp
--- ----
0    56
1    48
2    46
3    40
4    34
5    32
6    26
7    24

```

DSCP-to-CoS Map

```

DSCP-to-CoS          DSCP          CoS

DSCP-to-CoS Map      QOS          ,
DSCP-to-CoS Map      :

```

<pre> configure terminal </pre>	<pre> DSCP to COS Map dscp-list DSCP DSCP DSCP CoS 0 7 </pre>
<pre> mls qos map dscp-cos dscp-list to cos </pre>	<pre> DSCP CoS 0 7 </pre>
<pre> no mls qos map dscp-cos </pre>	

```

DSCP 0 32 56          6

```

```

Ruijie# configure terminal
Ruijie(config)# mls qos map dscp-cos 0 32 56 to 6
Ruijie(config)# show mls qos maps dscp-cos

```

dscp	cos	dscp	cos	dscp	cos	dscp	cos
----	---	----	---	----	---	----	---
0	6	1	0	2	0	3	0
4	0	5	0	6	0	7	0
8	1	9	1	10	1	11	1
12	1	13	1	14	1	15	1
16	2	17	2	18	2	19	2
20	2	21	2	22	2	23	2
24	3	25	3	26	3	27	3
28	3	29	3	30	3	31	3
32	6	33	4	34	4	35	4
36	4	37	4	38	4	39	4
40	5	41	5	42	5	43	5
44	5	45	5	46	5	47	5
48	6	49	6	50	6	51	6
52	6	53	6	54	6	55	6
56	6	57	7	58	7	59	7
60	7	61	7	62	7	63	7



%current port's buffer management mode: qos

QOS

class-map

class-map

show class-map [<i>class-name</i>]	class map

```
Ruijie# show class-map
Class Map cc
Match access-group 1
Ruijie#
```

policy-map

Policy-map

show policy-map [<i>policy-name</i> [class <i>class-name</i>]]	QoS policy map policy-name policy map class class-name policy map class map

```
Ruijie# show policy-map
Policy Map pp
Class cc
Ruijie#
```

mls qos interface

qos

--	--

show mls qos interface [<i>interface</i> <i>policers</i>]	QoS , Policers Policy map
--	---------------------------------

```
Ruijie# show mls qos interface gigabitEthernet 0/4
Interface: GigabitEthernet 0/4
Attached input policy-map: pp
Default COS: trust dscp
Default COS: 6
Ruijie#show mls qos interface policers
Interface: GigabitEthernet 0/4
Attached input policy-map: pp
Ruijie#
```

mls qos virtual-group

qos

show mls qos virtual-group [<i>virtual-group-number</i> policers]	police Policers police
---	------------------------------

```
Ruijie# show mls qos virtual-group 1
Virtual-group: 1
Attached input policy-map: pp
Ruijie# show mls qos virtual-group policers
Virtual-group: 1
Attached input policy-map: pp
Ruijie#
```

mls qos queueing

qos

show mls qos queueing	QoS , CoS-to-queue map wrr weight drr weight;
------------------------------	---

```
Ruijie# show mls qos queueing
Cos-queue map:
cos qid
--- ---
0 1
1 2
2 1
3 4
4 1
5 1
6 1
7 1
wrr bandwidth weights:
qid weights
--- -----
0 1
1 2
2 3
3 4
4 5
5 6
6 7
7 8
```

mls qos scheduler

QOS

show mls qos scheduler	

```
Ruijie# show mls qos scheduler
Global Multi-Layer Switching scheduling
Strict Priority
Ruijie#
```

mls qos maps

mls qos maps

show mls qos maps [cos-dscp dscp-cos ip-prec-dscp]	dscp-cos maps dscp-cos maps ip-prec-dscp maps

```
Ruijie# show mls qos maps cos-dscp
```

```
cos dscp
```

```
--- ----
```

```
0 0
1 8
2 16
3 24
4 32
5 40
6 48
7 56
```

```
Ruijie# show mls qos maps dscp-cos
```

```
dscp cos      dscp cos      dscp cos      dscp cos
```

```
---- -
```

```
0 6      1 0      2 0      3 0
4 0      5 0      6 0      7 0
8 1      9 1      10 1     11 1
12 1     13 1     14 1     15 1
16 2     17 2     18 2     19 2
20 2     21 2     22 2     23 2
24 3     25 3     26 3     27 3
28 3     29 3     30 3     31 3
32 6     33 4     34 4     35 4
36 4     37 4     38 4     39 4
40 5     41 5     42 5     43 5
44 5     45 5     46 5     47 5
48 6     49 6     50 6     51 6
52 6     53 6     54 6     55 6
56 6     57 7     58 7     59 7
60 7     61 7     62 7     63 7
```

```
Ruijie# show mls qos maps ip-prec-dscp
```

```
ip-precedence dscp
```

```
-----
```

```
0      56
1      48
2      46
3      40
```

4	34
5	32
6	26
7	24

mls qos rate-limit

<code>show mls qos rate-limit [interface <i>interface</i>]</code>	[]

```
Ruijie# show mls qos rate-limit
Interface: GigabitEthernet 0/4
rate limit input bps = 100 burst = 100
```

show policy-map interface

polic

```
Ruijie# show buffer management
%current port's buffer management mode: qos
```

virtual-group

virtual-group

show virtual-group <i>[virtual-group-number summary]</i>	

```
Ruijie#show virtual-group 1
virtual-group      member
-----
1                  Gi0/2 Gi0/3 Gi0/4 Gi0/5
                   Gi0/6 Gi0/7 Gi0/8 Gi0/9 Gi0/10
```

```
Ruijie#show virtual-group summary
virtual-group      member
-----
1                  Gi0/1 Gi0/2 Gi0/3 Gi0/4
                   Gi0/5 Gi0/6 Gi0/7 Gi0/8 Gi0/9
2                  Gi0/11 Gi0/12 Gi0/13 Gi0/14
                   Gi0/15 Gi0/16 Gi0/17 Gi0/18 Gi0/19
```

QOS

```
G0/2
512Kbps
```

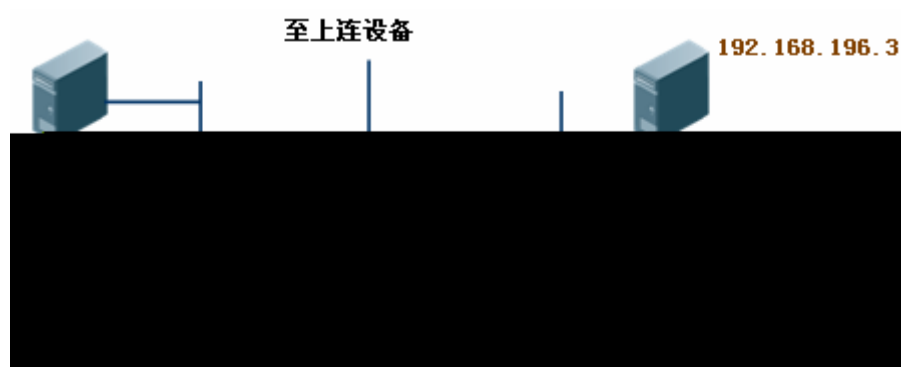

/

QOS ACL

```
#
Ruijie#configure
Enter configuration commands, one per line. End with CNTL/Z.
#      salary_acl      ACL
Ruijie(config)#ip access-list standard salary_acl
#
Ruijie(config-std-nacl)#permit host 192.168.217.223
#
Ruijie(config-std-nacl)#exit
#      salaryclass  class map      class-map
Ruijie(config)#class-map salaryclass
#
Ruijie(config-cmap)#match access-group salary_acl
#
Ruijie(config-cmap)#exit
```

```
#          salarypolicy          policy-map
Ruijie(config)#policy-map salarypolicy

#          salaryclass
Ruijie(config-pmap)#class salaryclass

#          512Kbps          32
Kbyte

Ruijie(config-pmap-c)#police 512 32 exceed-action drop

#          class-map
Ruijie(config-pmap-c)#exit

#
Ruijie(config-pmap)#exit

#          G0/2
Ruijie(config)#interface gigabitEthernet 0/2

#          salarypolicy          G0/2
Ruijie(config-if)#service-policy input salarypolicy

#
Ruijie(config-if)#end

#          show
```

VRRP

VRRP (Virtual Router Redundancy Protocol)

VRRP

VRRP

VRRP

RFC 2338

VRRP

IP

VRRP

VRRP

IP

IP

VRRP

VRRP

RFC 2338

VRRP

VRRP

VRRP

Master

IP

IP

(Backup)

VRRP

VRRP

Master

Master

1)

VRRP

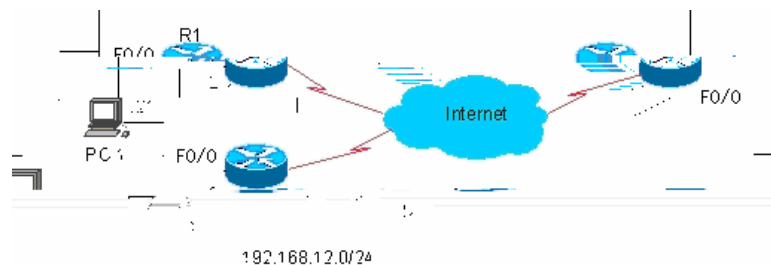

B C

VRRP

3

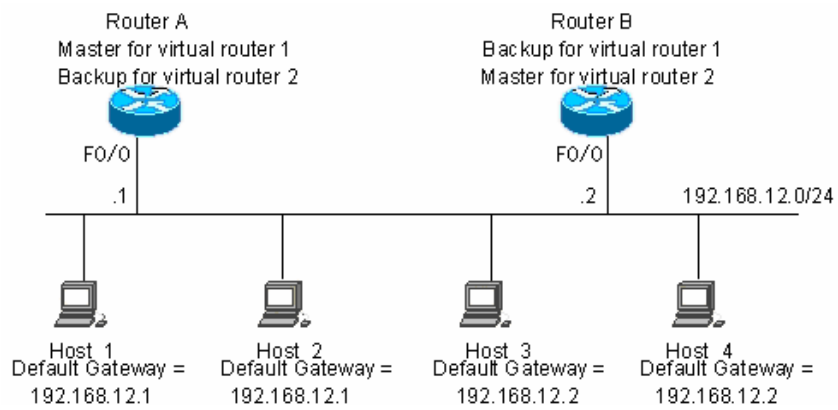

3 VRRP

3				1	A	
Fa0/0	IP	192.168.12.1		IP		A

	VRRP
	VRRP

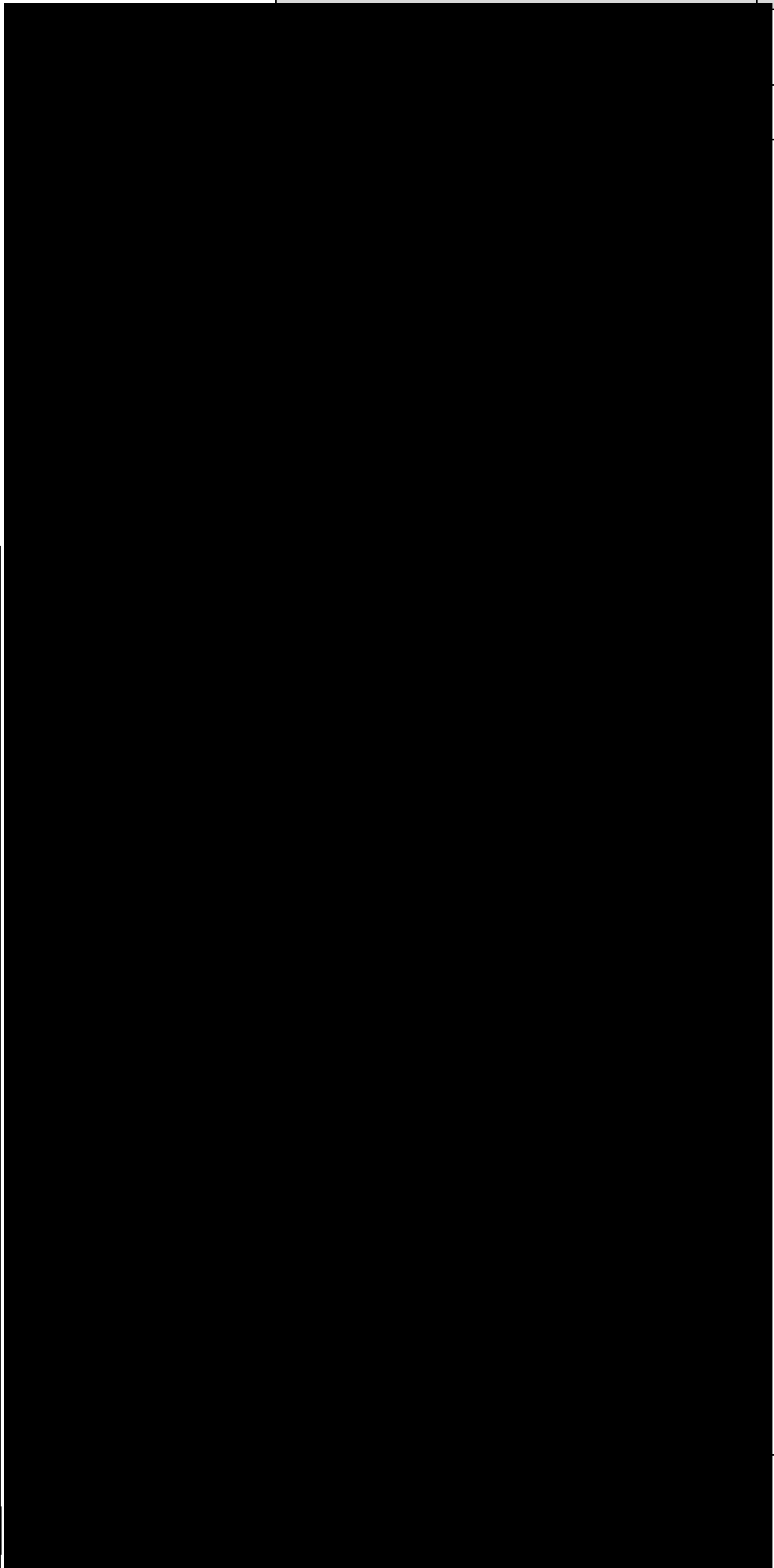

/

```
State is Master
Virtual IP address is 192.168.201.2 configured
Virtual MAC address is 0000.5e00.0102
Advertisement interval is 3 sec
Preemption is enabled
min delay is 0 sec
Priority is 120
Master Router is 192.168.201.217 (local), priority is 120
Master Advertisement interval is 3 sec
Master Down interval is 9 sec
```

	VRRP	IP	VRRP	Master
IP	Master	Master	MAC	Master

VRRP

2. show vrrp brief

```
Ruijie# show vrrp brief
Interface      Grp Pri Time Own Pre State  Master addr  Group
addr
FastEthernet0/0 1 100 - - P Backup 192.168.201.213
192.168.201.1
FastEthernet0/0 2 120 - - P Master 192.168.201.217
192.168.201.2
```

	VRRP
IP	Master

IP

3. show vrrp interface

```
Ruijie# show vrrp interface FastEthernet 0/0
FastEthernet 0/0 - Group 1
State is Backup
Virtual IP address is 192.168.201.1 configured
Virtual MAC address is 0000.5e00.0101
Advertisement interval is 3 sec
Preemption is enabled
min delay is 0 sec
Priority is 100
Master Router is 192.168.201.213 , pritority is 120
Master Advertisement interval is 3 sec
Master Down interval is 9 sec
FastEthernet 0/0 - Group 2
State is Master
Virtual IP address is 192.168.201.2 configured
Virtual MAC address is 0000.5e00.0102
Advertisement interval is 3 sec
Preemption is enabled
```

```
min delay is 0 sec
Priority is 120
Master Router is 192.168.201.217 (local), priority is 120
Master Advertisement interval is 3 sec
Master Down interval is 9 sec
Ruijie#
```

VRRP: Grp 1 Advertisement from 192.168.201.213 has invalid
virtual address 192.168.1.1

192.168.201.213

VRRP

1

VRRP

120

5.

R3

R3

```

!
!
hostname "R3"
!
!
!
interface FastEthernet 0/0
no switchport
ip address 192.168.12.217 255.255.255.0
!
interface GigabitEthernet 1/1
no switchport
ip address 60.154.101.5 255.255.255.0
!
interface GigabitEthernet 2/1
no switchport
ip address 202.101.90.61 255.255.255.0
!
router ospf
network 202.101.90.0 0.0.0.255 area 10
network 192.168.12.0 0.0.0.255 area 10
network 60.154.101.0 0.0.0.255 area 10
!
!
!
end

```

VRRP

```

4 (192.168.201.0/24)
R1 R2
IP 192.168.201.1 192.168.201.1
( 192.168.12.0 /24) R1 VRRP Master
R1 (192.168.201.)
R1 R2
(192.168.201.1) R1 R2
R1
!
!
hostname "R1"
!

```

```
!  
interface FastEthernet 0/0  
no switchport  
ip address 192.168.201.217 255.255.255.0  
vrrp 1 priority 120  
vrrp 1 timers advertise 3  
vrrp 1 ip 192.168.201.1  
!  
interface GigabitEthernet 2/1  
no switchport  
ip address 202.101.90.63 255.255.255.0  
!  
router ospf  
network 202.101.90.0 0.0.0.255 area 10  
network 192.168.201.0 0.0.0.255 area 10  
!
```

R2

```
!  
hostname "R2"  
!  
interface FastEthernet 0/0  
no switchport  
ip address 192.168.201.213 255.255.255.0  
vrrp 1 ip 192.168.201.1  
vrrp 1 timers advertise 3  
!  
interface GigabitEthernet 1/1  
no switchport  
ip address 60.154.101.3 255.255.255.0  
!  
!  
router ospf  
network 60.154.101.0 0.0.0.255 area 10  
network 192.168.201.0 0.0.0.255 area 10  
!  
!  
end
```

	R1	R2	VRRP	1
IP	(192.168.201.1)		1.1)	

VRRP

4

```

!
hostname "R2"
!
interface FastEthernet 0/0
no switchport
ip address 192.168.201.213 255.255.255.0
vrrp 1 ip 192.168.201.1
vrrp 1 timers advertise 3
!
interface GigabitEthernet 1/1
no switchport
ip address 60.154.101.3 255.255.255.0
!
router ospf
network 60.154.101.0 0.0.0.255 area 10
network 192.168.201.0 0.0.0.255 area 10
!
!
end

```

```

          R1  R2      VRRP      1      VRRP
          (      )      IP      (192.168.201.1)      VRRP
                    R2      VRRP      (Advertisement)
3                    R1      VRRP      120
R2      VRRP                    100      R1
Master                    R1      Master
          GigabitEthernet 2/1                    R1      VRRP
          30      90                    R2      Master
          R1                    GigabitEthernet 2/1
VRRP                    30      120      R1

```

VRRP

VRRP

```

4                    (192.168.201.0/24)
R1  R2                    ( A)      1
IP      192.168.201.1                    ( C)      2
IP      192.168.201.2      R1      2
1                    R2      2
1                    R1  R2
          R1

```

```
!  
!  
hostname "R1"  
!  
interface FastEthernet 0/0  
no switchport  
ip address 192.168.201.217 255.255.255.0  
vrrp 1 timers advertise 3  
vrrp 1 ip 192.168.201.1  
vrrp 2 priority 120  
vrrp 2 timers advertise 3  
vrrp 2 ip 192.168.201.2  
vrrp 2 track GigabitEthernet 2/1 30  
!  
interface GigabitEthernet 2/1  
no switchport  
ip address 202.101.90.63 255.255.255.0  
!  
router ospf  
network 202.101.90.0 0.0.0.255 area 10  
network 192.168.201.0 0.0.0.255 area 10  
!  
!  
end
```

R2

```
!  
!  
hostname "R2"  
!  
!  
interface Loopback 0  
ip address 20.20.20.5 255.255.255.0  
!  
interface FastEthernet 0/0  
no switchport  
ip address 192.168.201.213 255.255.255.0  
vrrp 1 ip 192.168.201.1  
vrrp 1 timers advertise 3  
vrrp 1 priority 120  
vrrp 2 ip 192.168.201.2  
vrrp 2 timers advertise 3  
!  
interface GigabitEthernet 1/1  
no switchport  
ip address 60.154.101.3 255.255.255.0
```

```
!  
router ospf  
network 60.154.101.0 0.0.0.255 area 10  
network 192.168.201.0 0.0.0.255 area 10  
!  
!  
!  
end
```

R2 R2 VRRP 1 2

VRRP

VRRP

IP Ping

```
,  
,  
VRRP Ping IP show vrrp VRRP :  
,  
ARP IP ARP  
,  
IP  
VRRP Master  
, VRRP VRRP  
, VRRP VRRP  
, VRRP  
, VRRP VRRP  
, VRRP VRRP IP
```

BFD

BFD

BFD

BFD(Bidirectional Forwarding Detection)

```

3—          Down
4—
5—
6—
7—   Down
'  Sta BFD          0   AdminDown 1   Down 2   Init
3   Up
'  P          BFD
'  F   P          F
'  C   /          BFD
      OSPF   OSPF   /GR   BFD
'  A
'  D
'  M          0
'  Detect Mult
'  Length
'  My Discreaminator BFD
'  Your Discreaminator BFD
'  Desired Min Tx Interval          BFD
'  Required Min RX Interval          BFD
'  Required Min Echo RX Interval          Echo
      Echo          0
'  Auth Type          ( )
Simple Password
Keyed MD5
Meticulous Keyed MD5
Keyed SHA1
Meticulous Keyed SHA1
'  Auth Length
'  Authentication Data

---

r          RGOS   10.3(4b3)          1   0
          1          0
          0

---



```

BFD

BFD
 OSPF BGP RIP BFD

BFD

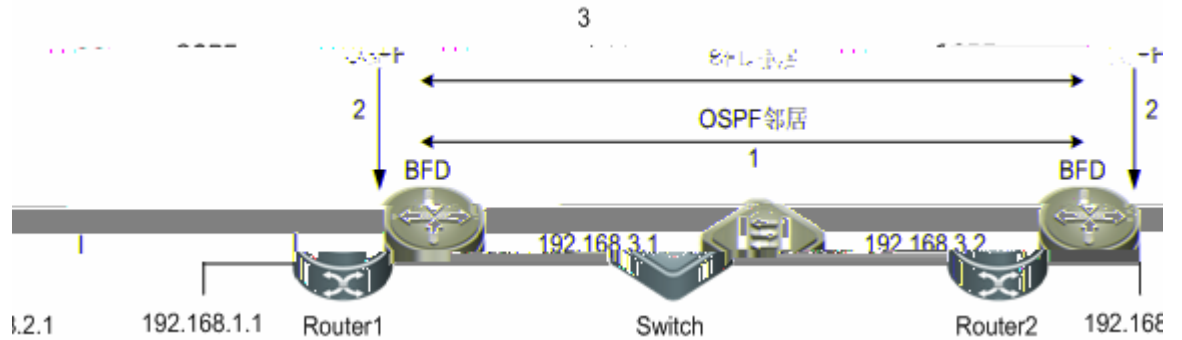

3BFD

2
 OSPF BFD BFD :
 1 :OSPF
 2 :OSPF BFD
 3 :BFD

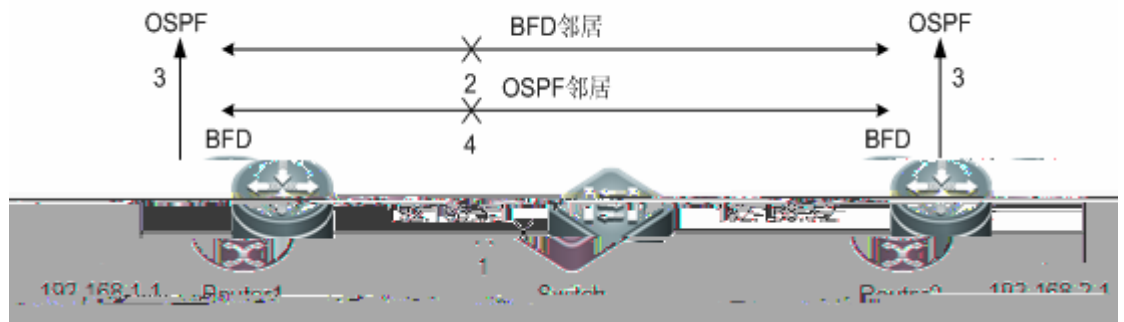

4BFD

3 BFD :
 1 :Router1 Switch
 2 :Router1 Router2 BFD
 3 :BFD OSPF
 4 :OSPF

BFD

- ' draft-ietf-bfd-base-09 Bidirectional Forwarding Detection
- ' draft-ietf-bfd-generic-05 Generic Application of BFD
- ' draft-ietf-bfd-v4v6-1hop-09 BFD for IPv4 and IPv6 (Single Hop)
- ' draft-ietf-bfd-multihop-07 BFD for IPv4 and IPv6 (Multihop)

r	10.3(4b3)	draft-ietf-bfd-mpls-07
	RGS10.3(4b3)	draft-ietf-bfd-mib-06

BFD

BFD

- ' BFD
- ' BFD
- ' BFD
- ' BFD
- ' BFD
- ' BFD
- ' BFD
- ' BFD
- ' BFD VRRP
- ' BFD VRF
- ' BFD

BFD

BFD

1.

BFD

BFD

2.

BFD

BFD

r	10.3(4b3)
---	-----------

BFD

BFD

1.

BFD

BFD

Down

2.

BFD

BFD

BFD

Down

3.

BFD

Do

wn

BFD

r	RGOS10.3(4b3)		
	no ip deny land	no ip redirects	IP
	BFD	BFD	Land-based DDOS
			1

BFD

BFD (Desired Min Tx Interval
Required Min RX Interval Detect Mult) BFD
UP

BFD

BFD

1. Simple Password
2. Keyed MD5

3. Meticulous Keyed MD5
4. Keyed SHA1
5. Meticulous Keyed SHA1

r	RGOS10.3(4b3)	BFD
---	---------------	-----

BFD

BFD

BFD

“HEELO”

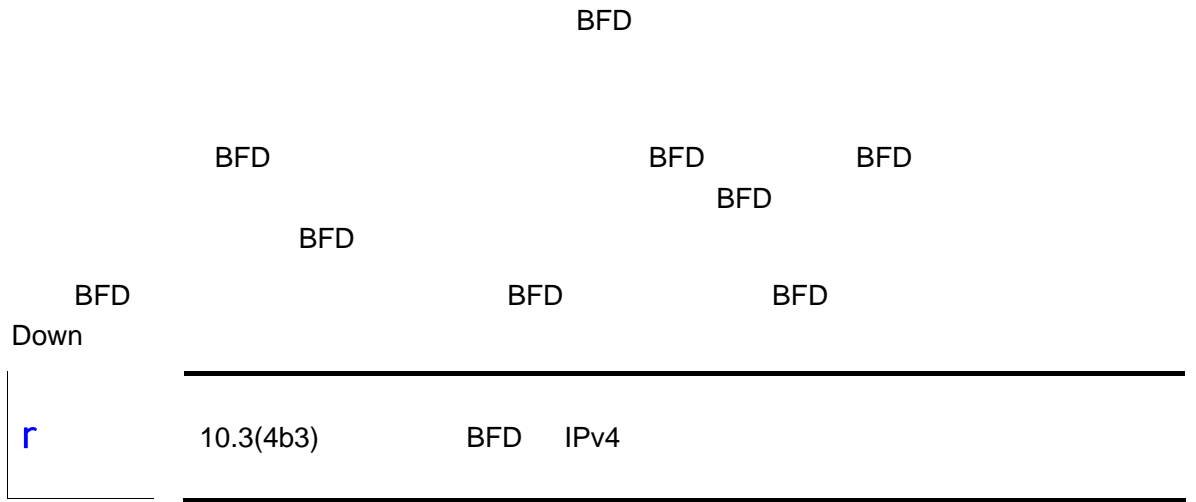

BFD VRRP



BFD VRF

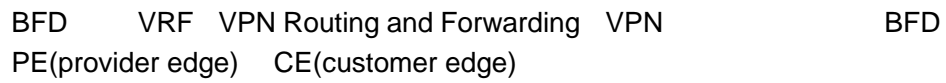

BFD

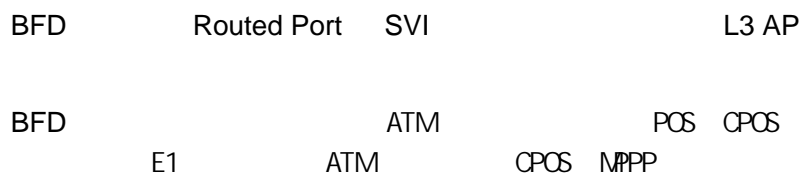

BFD

BFD

- ' () BFD
- ' () BFD
- ' () BFD
- ' () RIP BFD
- ' () OSPF BFD
- ' () BFD
- ' () BFD
- ' () VRRP BFD

BFD

BFD	
BFD	
BFD	
BFD	
BFD	
BFD	
BFD	
BFD VRRP	
BFD VRF	

BFD

BFD

Step 1	Ruijie> enable
Step 2	Ruijie# configure terminal
Step 3	Ruijie(config)# interface <i>type number</i>
Step 4	<div style="display: flex; justify-content: space-between;"> <div style="width: 60%;"> Ruijie(config-if)#bfd interval <i>milliseconds</i> min_rx <i>milliseconds</i> multiplier interval-multiplier </div> <div style="width: 35%;"> BFD interval <i>milliseconds</i> , min_rx <i>milliseconds</i> multiplier interval-multiplier </div> </div>

Step 5	Ruijie(config-if)# end	
	BFD	no bfd interval
<pre> # Routed Port FastEthernet 0/2 BFD Ruijie# configure terminal Enter configuration commands, one per line. End with CNTL/Z. Ruijie(config)# interface fastEthernet 0/2 Ruijie(config-if)# bfd interval 100 min_rx 100 multiplier 3 </pre>		
	L3 AP	BFD

BFD

BFD

BFD

BFD

Step 1	Ruijie> enable	
Step 2	Ruijie# configure terminal	
Step 3	Ruijie(config)# interface type number	
Step 4	Ruijie(config-if)# bfd echo	
Step 5	Ruijie(config-if)# end	
	BFD	

Step 2 Ruijie# **configure terminal**

Step 3 Ruijie(config)#**bfd slow-timer** [*milliseconds*]

Ey 36• õax õPc`î <€,€K,XPáPa ç-ÏÏ0

RIP BFD

RIP

```
RIP      BFD      RIP      (RIP
)      BFD      BFD      RIP
)      1      180      (RIP
```

bfd all-interfaces

RIP BFD

45E21354216993.08C2_0 1 T(en)7(abl3 Te)54<2FAp>6p 07d(0G)56 T@ (1 T)0|È 7.497 0 TTd ()Tj/TT0 A4B.961234.8B

```

RIP BFD
)
RIP BFD
unnumbered
BFD
IP BFD
BFD
BFD

```

OSPF BFD

```

OSPF Hello OSPF BFD
FULL BFD BFD BF
D OSPF 120 (
OSPFhello 30
4 120s) 1
bfd all-interfaces OSPF BFD
ip ospf bfd [disable]
OSPF BFD

```

Step 1	Ruijie>enable	
Step 2	Ruijie# configure terminal	
Step 3	Ruijie(config)# router ospf process-id	Router
Step 4	Ruijie(config-router)# bfd all-interfaces	no OSPF BFD RIP BFD
Step 5	Ruijie(config-router)# exit	() Router
Step 6	Ruijie(config)# interface type number	()
Step 7	Ruijie(config-if)# ip rip bfd [disable]	() OSPF BFD
Step 8	Ruijie(config-if)#end	()
Step 9	Ruijie#show bfd neighbors [details]	() BFD OSPF
Step 10	Ruijie#show ip ospf	() OSPF

```

OSPF BFD Router no
bfd all-interfaces

```

```

#           FastEthernet 0/2           OSPF   BFD
Ruijie#configure terminal
Enter configuration commands, one per line.  End with CNTL/Z.
Ruijie(config)# router ospf 123
Ruijie(config-router)# bfd all-interfaces
Ruijie(config-router)# exit
Ruijie(config)# interface FastEthernet 0/2
Ruijie(config-if)# ip ospf bfd disable
Ruijie(config-if)#end
    
```

	10.3(4b3)	OSPFv3	BFD
	OSPF	BFD	BFD
r	IP	BFD	BFD
	BFD		BFD
	OSPFv2/OSPFv3		BFD

BFD

BFD .

Step 1	Ruijie>enable	
Step 2	Ruijie# configure terminal	
Step 3	Ruijie(config)#ip route static bfd [vrf vrf-name] interface-type interface-number gateway [source ip-address]	BFD interface-type interface-number gateway IP source ip-address IP BFD BFD ,
Step 4		

Step 6

Ruijie#**show bfd neighbors [details]**

() BFD

BFD

no ip route static

bfd [vrf vrf-name] interface-type interface-number gateway

BFD BFD 172.16.0.2

Ruijie# **configure terminal**

Enter configuration commands G3wTj/TT09online. End 5(6(ith CNTL/Z.J/TT30497

X9&+m+

BFD

Step10	Ruijie# show bfd neighbors [details]	() BFD
Step11	Ruijie# show route-map	()

```

          BFD          router-map          no set ip
next-hop verify-availability [next-hop-address [track number | bfd [vrf
vrf-name] interface-type interface-number gateway]]
:
#          BFD          BFD          172.16.0.2

```

```

Ruijie#configure terminal
Enter configuration commands, one per line. End with CNTL/Z.
Ruijie(config)# route-map Example1 permit 10
Ruijie(config-route-map)# match ip address 1
Ruijie(config-route-map)# set ip precedence priority
Ruijie(config-route-map)#set ip next-hop verify-availability
172.16.0.2 bfd FastEthernet 0/1 172.16.0.2
Ruijie(config-route-map)#end
Ruijie(config)#interface FastEthernet 0/1
Ruijie(config-if)#no switchport
Ruijie(config-if)#ip address 172.16.0.1 255.255.255.0
Ruijie(config-if)#bfd interval 50 min_rx 50 multiplier 3
Ruijie(config-if)#ip policy route-map Example1
Ruijie(config-if)#exit

```

```

r          10.3(4b3)          PBRv6  BFD

```

VRRP BFD

VRRP BFD

Step 1	Ruijie> enable			
Step 2	Ruijie# configure terminal			
Step 3	Ruijie(config)# interface <i>type number</i>			
Step 4	Ruijie(config-if)# vrrp <i>group-number</i> ip [<i>ip-address</i> [secondary]]		VRRP	IP
Step 5	Ruijie(config-if)# vrrp <i>group-number</i> bfd <i>ip-address</i>	VRRP IP	BFD	<i>ip-address</i>

Step 6	Ruijie(config)# end		
Step 8	Ruijie# show bfd neighbors [details]	()	BFD VRRP
Step 9	Ruijie# show vrrp	()	VRRP

```

VRRP      BFD
group-number bfd

```

```

:
#          VRRP      BFD          BFD

```

Ruijie#**configure terminal**

Enter configuration commands, one per line. End with CNTL/Z.

Ruijie(config)#**interface** FastEthernet 0/1

Ruijie(config-if)#**no switchport**

Ruijie(config-if)#**ip address** 192.168.201.11 255.255.255.0

Ruijie(config-if)#**bfd interval** 50 **min_rx** 50 **multiplier** 3

Ruijie(config-if)#**vrrp** 1

```
Ruijie(config)#interface FastEthernet 0/1
Ruijie(config-if)#no switchport
Ruijie(config-if)#ip address 192.168.1.1 255.255.255.0
Ruijie(config-if)#bfd interval 50 min_rx 50 multiplier 3
Ruijie(config)#interface FastEthernet 0/2
Ruijie(config-if)#no switchport
Ruijie(config-if)#ip address 192.168.201.17 255.255.255.0
Ruijie(config-if)#vrrp 1 priority 120
Ruijie(config-if)#vrrp 1 ip 192.168.201.1
Ruijie(config-if)#vrrp 1 track bfd FastEthernet 0/1 192.168.1.3
30
Ruijie(config-if)#end
```

BFD

BFD

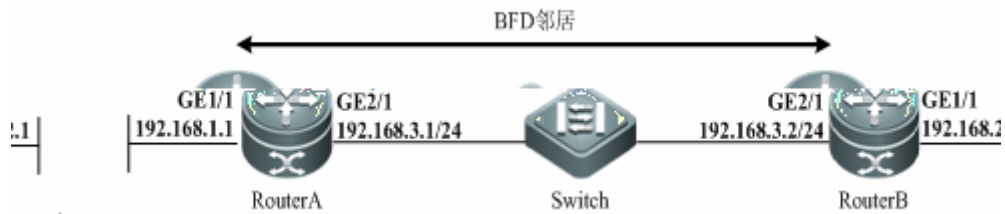

12 RIP BFD

1) RouterA

```
# RouterA Routed Port ge2/1 IP BFD
```

```
Ruijie# configure terminal
```

```
Enter configuration commands, one per line. End with CNTL/Z.
```

```
Ruijie(config)# interface GigabitEthernet2/1
```

```
Ruijie(config-if)# ip address
```

```
# Routed Port ge1/1
```

```
Ruijie(config-if)#
```

```
interface GigabitEthernet1/1 C2_0 14.97 -1.515 Td(Ruijie  
ip address
```

```
# RIP RIP BFD 192.168.3.2
```

```
Ruijie(config-if)#
```

```
r o u t e r r i p  
v e r s
```

```
Ruijie(config-if)# no switchport
Ruijie(config-if)# ip address 192.168.3.2 255.255.255.0
Ruijie(config-if)# bfd interval 50 min_rx 50 multiplier 3
#    Routed Port    ge1/1
Ruijie(config-if)# exit
Ruijie(config)# interface GigabitEthernet1/1
Ruijie(config-if)# no switchport
Ruijie(config)# ip address 192.168.2.1 255.255.255.0
#    RIP            RIP            BFD            192.168.3.1
Ruijie(config-if)# exit
Ruijie(config-router)# router rip
Ruijie(config-router)# version 2
Ruijie(config-router)# network 192.168.3.0
Ruijie(config-router)# network 192.168.2.0
Ruijie(config-router)# passive-interface GigabitEthernet 2/1
Ruijie(config-router)# bfd all-interfaces
Ruijie(config-router)# end
Ruijie#
```

1) RouterA BFD

```
Ruijie# show bfd neighbors details
```

OurAddr	NeighAddr	LD/RD	RH	Holdown(mult)	State	Int
192.168.3.1	192.168.3.2	1/2	1	532 (3)	Up	Ge2/1

```
Local Diag: 0, Demand mode: 0, Poll bit: 0
```

My Discr.: 2 - Your Discr.: 1
 Min tx interval: 50000 - Min rx interval: 50000
 Min Echo interval: 0

OurAddr	I P
NeighAddr	I P
LD/RD	
RH	
Holddown(mult)	hel l o
State	
Int	
Session state is UP and using echo function with 50 ms interval	(echo echo Echo)
Local Diag	
Demand mode	
Poll bit	
MinTxInt	
MinRxInt	
Multiplier	
Received MinRxInt	
Received Multiplier	
Holddown (hits)	
Hello (hits)	hel l o
Rx Count	BFD
Rx Interval (ms) min/max/avg	
Tx Count	BFD
Tx Interval (ms) min/max/avg	
Registered protocols	
Uptime	UP
Last packet	BFD

5

2) RouterB BFD

Ruijie# **show bfd neighbors details**

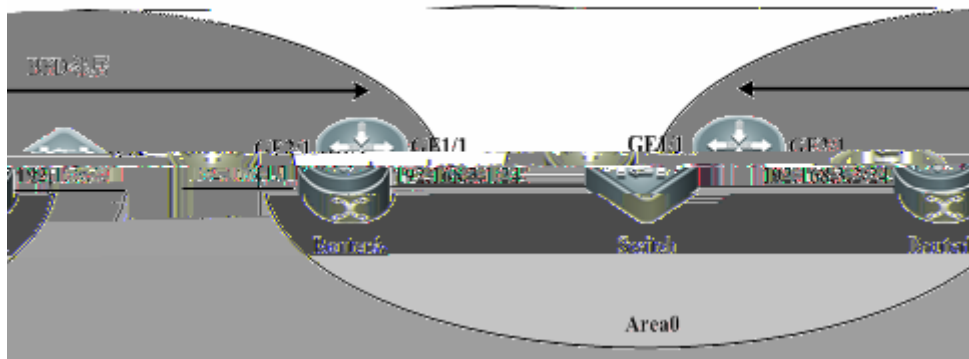

13 OSPF BFD

1) RouterA

```

# RouterA      Routed Port      IP      BFD

Ruijie# configure terminal
Enter configuration commands, one per line. End with CNTL/Z.
Ruijie(config)# interface GigabitEthernet2/1
Ruijie(config-if)# no switchport
Ruijie(config-if)# ip address 192.168.3.1 255.255.255.0
Ruijie(config-if)# bfd interval 200 min_rx 200 multiplier 5
#      Routed Port      gel/1
Ruijie(config-if)# exit
Ruijie(config)# interface GigabitEthernet1/1
Ruijie(config-if)# no switchport
Ruijie(config-if)# ip address 192.168.1.1 255.255.255.0
#      OSPF      OSPF      BFD      192.168.3.2

Ruijie(config-if)# exit
Ruijie(config-router)# router ospf 123
Ruijie(config-router)# log-adjacency-changes detail
Ruijie(config-router)# network 192.168.3.0 0.0.0.255 area 0
Ruijie(config-router)# network 192.168.1.0 0.0.0.255 area 0
Ruijie(config-router)# bfd all-interfaces

Ruijie(config-router)# end

Ruijie#

```

2) RouterB

```

# RouterA      Routed Port      IP      BFD

```

BFD

Multiplier: 3 - Length: 24
My Discr.: 2 - Your Discr.: 1
Min tx interval: 50000 - Min rx interval: 50000
Min Echo interval: 0

4) RouterB BFD

Ruijie# **show bfd neighbors details**

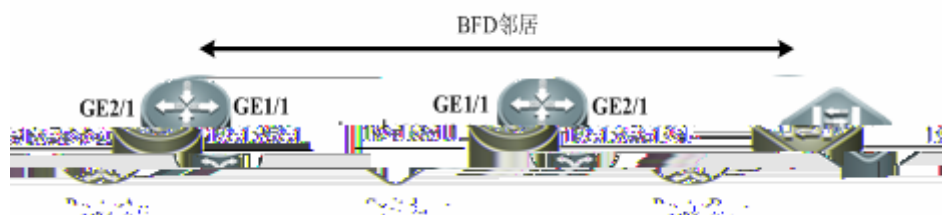

14 BFD

1) RouterA

```
# RouterA    Routed Port    ge2/1    IP        BFD

Ruijie# configure terminal
Enter configuration commands, one per line. End with CNTL/Z.
Ruijie(config)# interface GigabitEthernet2/1
Ruijie(config-if)# no switchport
Ruijie(config-if)# ip address 192.168.3.1 255.255.255.0
Ruijie(config-if)# bfd interval 200 min_rx 200 multiplier 5
#    Routed Port    ge1/1
Ruijie(config-if)# exit
Ruijie(config)# interface GigabitEthernet1/1
Ruijie(config-if)# no switchport
Ruijie(config)# ip address 192.168.1.1 255.255.255.0
#          BFD        192.168.3.2

Ruijie(config-if)# exit
Ruijie(config)# ip route static bfd GigabitEthernet 2/1 192.168.3.2

Ruijie(config)# ip route 192.168.2.0 255.255.255.0 GigabitEthernet 2/1
192.168.3.2

Ruijie(config)# endRuijie#
```

2) RouterB

```
# RouterA    Routed Port    IP        BFD

Ruijie# configure terminal
Enter configuration commands, one per line. End with CNTL/Z.
Ruijie(config)# interface GigabitEthernet 2/1
Ruijie(config-if)# no switchport
Ruijie(config-if)# ip address 192.168.3.2 255.255.255.0
```

```
Ruijie(config-if)# bfd interval 50 min_rx 50 multiplier 3  
# Routed Port    gel/1  
Ruijie(config-if)# exit  
Ruijie(config)# interface GigabitEthernet1/1  
Ruijie(config-if)# no switchport  
Ruijie(config)# ip address 192.168.2.1 255.255.255.0  
# BFD           192.168.3.1
```



15 BFD

1) RouterA

```
# RouterA    Routed Port    ge2/1    IP    BFD

Ruijie# configure terminal
Enter configuration commands, one per line. End with CNTL/Z.
Ruijie(config)# interface GigabitEthernet2/1
Ruijie(config-if)# no switchport
Ruijie(config-if)# ip address 192.168.3.1 255.255.255.0
Ruijie(config-if)# bfd interval 200 min_rx 200 multiplier 5
#    Routed Port    ge1/1
Ruijie(config-if)# exit
Ruijie(config)# interface GigabitEthernet1/1
Ruijie(config-if)# no switchport
Ruijie(config)# ip address 192.168.1.1 255.255.255.0
#    BFD    192.168.3.2

Ruijie(config)# ip access-list extended 100
Ruijie(config-ext-nacl)# permit ip any 10.10.10.0 0.0.0.255
Ruijie(config-ext-nacl)# deny ip any any
Ruijie(config-ext-nacl)# exit
Ruijie(config)# route-map Example1 permit 10
Ruijie(config-route-map)# match ip address 100
Ruijie(config-route-map)# set ip precedence priority
Ruijie(config-route-map)#set ip next-hop verify-availability
192.168.3.2 bfd GigabitEthernet 0/1 192.168.3.2
Ruijie(config)# end

Ruijie#
```

2) RouterB

```

# RouterA      Routed Port      IP      BFD

Ruijie# configure terminal
Enter configuration commands, one per line. End with CNTL/Z.
Ruijie(config)# interface GigabitEthernet 2/1
Ruijie(config-if)# no switchport
Ruijie(config-if)# ip address 192.168.3.2 255.255.255.0
Ruijie(config-if)# bfd interval 50 min_rx 50 multiplier 3
#      Routed Port      gel/1
Ruijie(config-if)# exit
Ruijie(config)# interface GigabitEthernet1/1
Ruijie(config-if)# no switchport
Ruijie(config)# ip address 192.168.2.1 255.255.255.0
#      BFD      192.168.3.1

Ruijie(config)# ip access-list extended 100

Ruijie(config-ext-nacl)# permit ip any 10.10.11.0 0.0.0.255

Ruijie(config-ext-nacl)# deny ip any any

Ruijie(config-ext-nacl)# exit

Ruijie(config)# route-map Example1 permit 10

Ruijie(config-route-map)# match ip address 100

Ruijie(config-route-map)# set ip precedence priority

Ruijie(config-route-map)#set ip next-hop verify-availability
192.168.3.1 bfd GigabitEthernet 2/1 192.168.3.1

Ruijie(config)# end

Ruijie#

```

3) RouterA BFD

```

Ruijie# show bfd neighbors details

OurAddr      NeighAddr      LD/RD  RH  Holdown(mult)  State  Int
192.168.3.1  192.168.3.2  1/2    1   532 (3)        Up     Ge2/1

Local Diag: 0, Demand mode: 0, Poll bit: 0

MinTxInt: 200000, MinRxInt: 200000, Multiplier: 5
Received MinRxInt: 50000, Received Multiplier: 3
Holdown (hits): 600(22), Hello (hits): 200(84453)

Rx Count: 49824, Rx Interval (ms) min/max/avg: 208/440/332
Tx Count: 84488, Tx Interval (ms) min/max/avg: 152/248/196

```

Registered protocols: PBR

Uptime: 02:18:49

Last packet: **Version: 1** - Diagnostic: 0
 I Hear You bit: 1 - Demand bit: 0
 Poll bit: 0 - Final bit: 0
 Multiplier: 3 - Length: 24
 My Discr.: 2 - Your Discr.: 1
 Min tx interval: 50000 - Min rx interval: 50000
 Min Echo interval: 0

4) RouterB BFD

Ruijie# **show bfd neighbors details**

OurAddr	NeighAddr	LD/RD	RH	Holdown(mult)	State	Int
192.168.3.2	192.168.3.1	2/1	1	532 (5)	Up	Ge2/1

Local Diag: 0, Demand mode: 0, Poll bit: 0

MinTxInt: 50000, MinRxInt: 50000, Multiplier: 3

Received MinRxInt: 200000, Received Multiplier: 5

Holdown (hits): 600(22), Hello (hits): 200(84453)

Rx Count: 49824, Rx Interval (ms) min/max/avg: 209/440/332 last: 66 ms ago

Tx Count: 84488, Tx Interval (ms) min/max/avg: 153/249/197 last: 190 ms ago

Registered protocols: PBR

Uptime: 02:18:49

Last packet: **Version: 1** - Diagnostic: 0
 I Hear You bit: 1 - Demand bit: 0
 Poll bit: 0 - Final bit: 0
 Multiplier: 5 - Length: 24
 My Discr.: 1 - Your Discr.: 2
 Min tx interval: 200000 - Min rx interval: 200000
 Min Echo interval: 0

VRRP BFD

Router A Router B
 VRRP
 swich
 VRRP

Router A Router B RouterC RouterD Internet RouterA
 RouterC RouterB RouterD
 Router A Router B VRRP
 RouterA RouterC RouterB RouterD
 VRRP

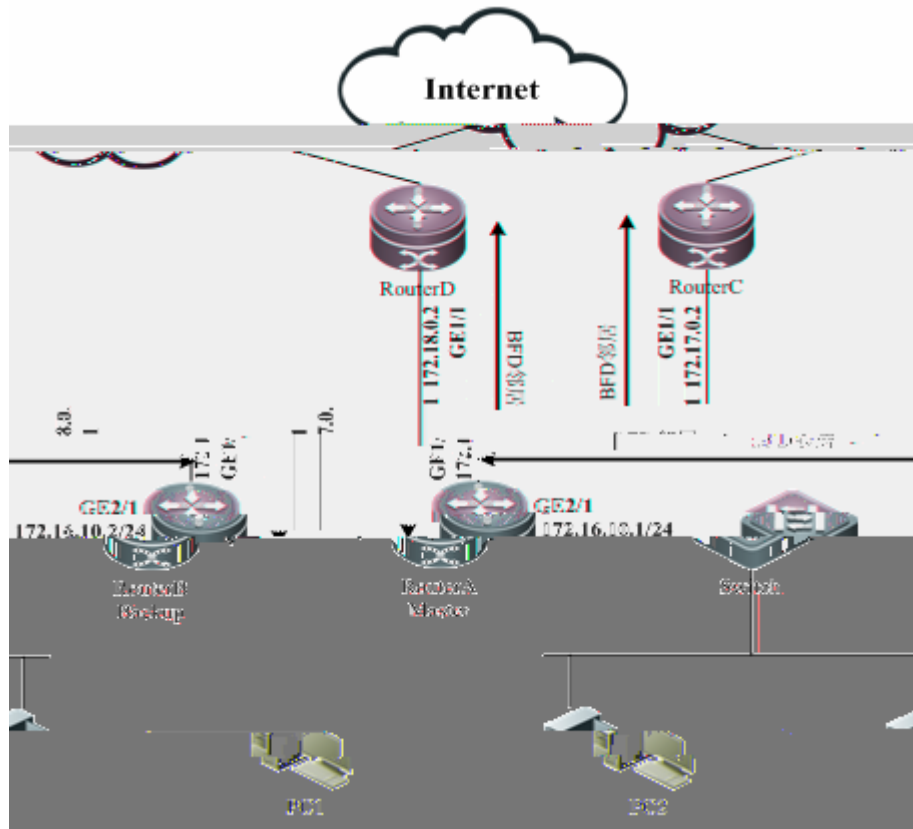

16 VRRP BFD

- 1) RouterC .
- 2) RouterD .
- 3) RouterA

```
# RouterA      Routed Port      IP      BFD

Ruijie# configure terminal
Enter configuration commands, one per line.  End with CNTL/Z.
Ruijie(config)# interface GigabitEthernet2/1
Ruijie(config-if)# no switchport
Ruijie(config-if)# ip address 172.16.10.1 255.255.255.0
Ruijie(config-if)# bfd interval 200 min_rx 200 multiplier 5
#      Routed Port      gel/1
Ruijie(config-if)# exit
Ruijie(config)# interface GigabitEthernet1/1
Ruijie(config-if)# no switchport
Ruijie(config-if)# ip address 172.17.0.1 255.255.255.0
Ruijie(config-if)# bfd interval 200 min_rx 200 multiplier 5
#      VRRP      VRRP      BFD      172.16.10.2
      BFD      172.17.0.2

Ruijie(config-if)# interface GigabitEthernet2/1
Ruijie(config-if)# vrrp 1 timers advertise 3
Ruijie(config-if)# vrrp 1 ip 172.16.10.3
Ruijie(config-if)# vrrp 1 priority 120
Ruijie(config-if)# vrrp 1 bfd 172.16.10.2
Ruijie(config-if)# vrrp 1 track bfd GigabitEthernet 1/1 172.17.0.2 30
#      BFD      172.17.0.2

Ruijie(config-if)# exit
Ruijie(config)# ip route static bfd GigabitEthernet 1/1 172.17.0.2

Ruijie(config)# ip route 0.0.0.0 0.0.0.0 GigabitEthernet 1/1 172.17.0.2

Ruijie(config)# end
Ruijie#
```

- 4) RouterB

```
# RouterB      Routed Port      IP      BFD

Ruijie# configure terminal
Enter configuration commands, one per line.  End with CNTL/Z.
Ruijie(config)# interface GigabitEthernet2/1
Ruijie(config-if)# no switchport
Ruijie(config-if)# ip address 172.16.10.2 255.255.255.0
Ruijie(config-if)# bfd interval 50 min_rx 50 multiplier 3
#      Routed Port      gel/1
```

```

Ruijie(config-if)# exit
Ruijie(config)# interface GigabitEthernet1/1
Ruijie(config-if)# no switchport
Ruijie(config-if)# ip address 172.18.0.1 255.255.255.0
Ruijie(config-if)# bfd interval 200 min_rx 200 multiplier 5

#      VRRP          VRRP          BFD          172.16.10.1
#      BFD          172.18.0.2

Ruijie(config-if)# interface GigabitEthernet2/1
Ruijie(config-if)# vrrp 1 timers advertise 3
Ruijie(config-if)# vrrp 1 ip 172.16.10.3
Ruijie(config-if)# vrrp 1 priority 90
Ruijie(config-if)# vrrp 1 bfd 172.16.10.1
Ruijie(config-if)# vrrp 1 track bfd GigabitEthernet 1/1 172.18.0.2 30
#      BFD          172.18.0.2

Ruijie(config-if)# exit
Ruijie(config)# ip route static bfd GigabitEthernet 1/1 172.18.0.2
Ruijie(config)# ip route 0.0.0.0 0.0.0.0 GigabitEthernet 1/1 172.18.0.2

Ruijie(config)# end
Ruijie#

```

1) RouterA BFD

```
Ruijie# show bfd neighbors details
```

OurAddr	NeighAddr	LD/RD	RH	Holdown(mult)	State	Int
172.16.10.1	172.16.10.2	1/2	1	532 (3)	Up	Ge2/1

Local Diag: 0, Demand mode: 0, Poll bit: 0

MinTxInt: 200000, MinRxInt: 200000, Multiplier: 5

Received MinRxInt: 50000, Received Multiplier: 3

Holdown (hits): 600(22), Hello (hits): 200(84453)

Rx Count: 49824, Rx Interval (ms) min/max/avg: 208/440/332

Tx Count: 84488, Tx Interval (ms) min/max/avg: 152/248/196

Registered protocols: VRRP

Uptime: 02:18:49

Last packet: **Version: 1** - Diagnostic: 0

 I Hear You bit: 1 - Demand bit: 0

 Poll bit: 0 - Final bit: 0

Multiplier: 3 - Length: 24
 My Discr.: 2 - Your Discr.: 1
 Min tx interval: 50000 - Min rx interval: 50000
 Min Echo interval: 0

OurAddr	NeighAddr	LD/RD	RH	Holdown(mult)	State	Int
172.17.0.1	172.17.0.2	2/3	1	532 (3)	Up	
Ge2/1						

Local Diag: 0, Demand mode: 0, Poll bit: 0

MinTxInt: 200000, MinRxInt: 200000, Multiplier: 5

Received MinRxInt: 50000, Received Multiplier: 3

Holdown (hits): 600(22), Hello (hits): 200(84453)

Rx Count: 49824, Rx Interval (ms) min/max/avg: 208/440/332 last: 68 ms ago

Tx Count: 84488, Tx Interval (ms) min/max/avg: 152/248/196 last: 192 ms ago

Registered protocols: VRRP,STATIC ROUTE

Uptime: 02:18:49

Last packet: **Version: 1** - Diagnostic: 0
 I Hear You bit: 1 - Demand bit: 0
 Poll bit: 0 - Final bit: 0
 Multiplier: 3 - Length: 24
 My Discr.: 2 - Your Discr.: 1
 Min tx interval: 50000 - Min rx interval: 50000
 Min Echo interval: 0

1) RouterB BFD

Ruijie# **show bfd neighbors details**

OurAddr	NeighAddr	LD/RD	RH	Holdown(mult)	State	Int
172.16.10.2	172.16.10.1	2/1	1	532 (3)	Up	Ge2/1

Local Diag: 0, Demand mode: 0, Poll bit: 0

MinTxInt: 50000, MinRxInt: 50000, Multiplier: 3

Received MinRxInt: 200000, Received Multiplier: 5

Holdown (hits): 600(22), Hello (hits): 200(84453)

Rx Count: 49824, Rx Interval (ms) min/max/avg: 208/440/332 last: 68 ms ago

Tx Count: 84488, Tx Interval (ms) min/max/avg: 152/248/196 last: 192 ms ago

Registered protocols: VRRP

Uptime: 02:18:49

Last packet: **Version: 1** - Diagnostic: 0
 I Hear You bit: 1 - Demand bit: 0
 Poll bit: 0 - Final bit: 0
 Multiplier: 3 - Length: 24
 My Discr.: 1 - Your Discr.: 2
 Min tx interval: 200000 - Min rx interval: 200000
 Min Echo interval: 0

OurAddr	NeighAddr	LD/RD	RH	Holdown(mult)	State	Int
172.18.0.1	172.18.0.2	1/3	1	532 (3)	Up	

Ge2/1

Local Diag: 0, Demand mode: 0, Poll bit: 0

MinTxInt: 200000, MinRxInt: 200000, Multiplier: 5

Received MinRxInt: 50000, Received Multiplier: 3

Holdown (hits): 600(22), Hello (hits): 200(84453)

Rx Count: 49824, Rx Interval (ms) min/max/avg: 208/440/332 last: 68 ms ago

Tx Count: 84488, Tx Interval (ms) min/max/avg: 152/248/196 last: 192 ms ago

Registered protocols: VRRP,STATIC ROUTE

Uptime: 02:18:49

Last packet: **Version: 1** - Diagnostic: 0
 I Hear You bit: 1 - Demand bit: 0
 Poll bit: 0 - Final bit: 0
 Multiplier: 3 - Length: 24
 My Discr.: 2 - Your Discr.: 1
 Min tx interval: 50000 - Min rx interval: 50000
 Min Echo interval: 0

RLDP

RLDP

RLDP

RLDP Rapid Link Detection Protocol

linkup

RLDP

RLDP

RLDP

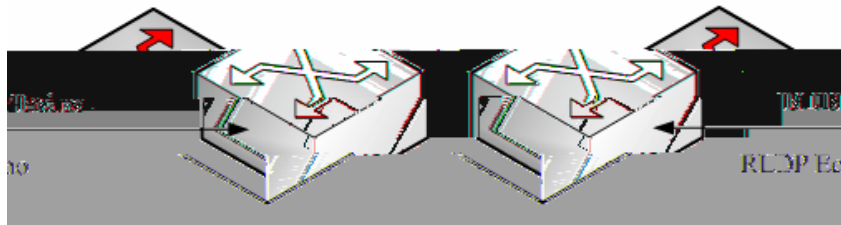

1

RLDP

RLDP

linkup

(Probe)

(Echo).RLDP

Probe

Probe

/

RLDP

RLDP

RLDP

RLDP

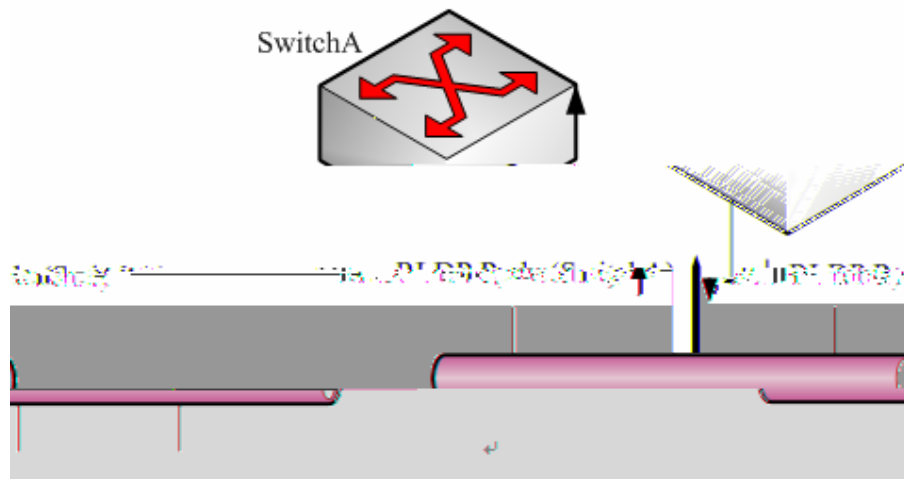

2

RLDP
RLDP
RLDP
svi
RLDP

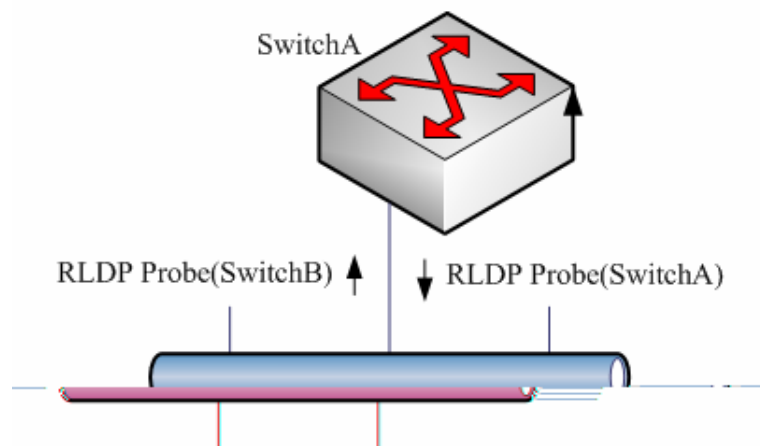

3

RLDP
RLDP

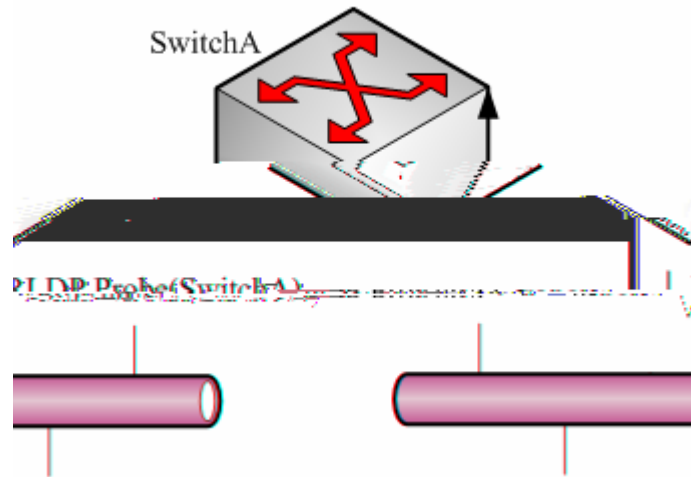

4

RLDP

/

RLDP

RLDP

RLDP

RLDP

' RLDP

' RLDP

' RLDP

' RLDP

' RLDP

' RLDP

RLDP

RLDP	DISABLE
RLDP	DISABLE

2S

Ruijie(config)# interface <i>interface-id</i>	
Ruijie(config-if)# rldp port { unidirection-detect bidirection-detect loop-detect } { warning shutdown-svi shutdown-port block }	RLDP
Ruijie(config-if)# end	

```

RLDP          no
GigabitEthernet 0/5    RLDP

```

```

Ruijie# configure terminal
Ruijie(config)# interface gigabitEthernet 0/5
Ruijie(config-if)# rldp port unidirection-detect shutdown-svi
Ruijie(config-if)# rldp port bidirection-detect warning
Ruijie(config-if)# rldp port loop-detect block
Ruijie(config-if)# end
Ruijie# show rldp interface gigabitEthernet 0/5
port state      : normal
local bridge    : 00d0.f822.33ac
neighbor bridge : 0000.0000.0000
neighbor port   :
unidirection detect information:
action : shutdown svi
state  : normal
bidirection detect information :
action : warning
state  : normal
loop detect information      :
action : block
state  : normal

```

```

'          shutdown-svi

```

```

'                                RLDP

```

```

'          aggregate port      block
                                aggregate port

```

RLDP

log

log

log
3

RLDP

RLDP

RLDP Probe

RLDP

Ruijie(config)# rldp detect-interval <i>interval</i>	interval 2-15s, 3s
Ruijie(config)# end	

RLDP

Ruijie# rldp reset	RLDP

/

```
errdisable recover
  rldp ( shutdown-port
) RLDP rldp
errdisable recover interval
errdisable recover interval
errdisable recover
interval ,
```

RLDP

```
RLDP
' RLDP
' RLDP
```

RLDP

RLDP

rldp

Ruijie# show rldp	RLDP rldp

```
port state:normal
neighbor bridge : 00d0.f800.41b0
neighbor port   : GigabitEthernet 0/2
unidirection detect information:
action : shutdown svi
state  : normal
interface GigabitEthernet 0/24
port state:error
neighbor bridge : 0000.0000.0000
neighbor port   :
bidirection detect information :
action : warning
state  : error
```

```
                GigabitEthernet 0/1
                (normal)         GigabitEthernet 0/24
```

RLDP

RLDP

--	--

Ruijie# **show rldp interface** *interface-id*

svi

error

svi shutdown

TPP

TPP

TPP(Topology Protection Protocol)

CPU

CPU

TPP

MSTP VRRP
MSTP VRRP

CPU

MSTP VRRP

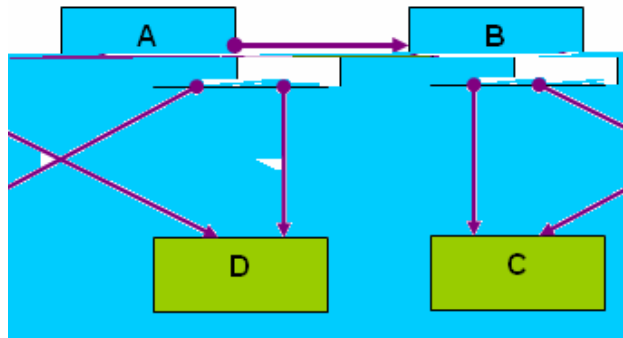

1

MSTP

A B

C D

A

A

CPU

BPDU

C D

B

C D

B

B

CPU

A

TPP

TPP

/

```

    TPP
    cpu
    cpu topology-limit
    50-70,
    cup
    TPP
    TPP
    TPP
    
```

no

Ruijie> enable	
Ruijie# config terminal	
Ruijie(config)# topology guard	
Ruijie(config)# end	
Ruijie# copy running-config startup-config	

no topology guard

Ruijie> enable	
Ruijie# config terminal	
Ruijie(config)# interface gi 0/1	
Ruijie(config-if)# tp-guard port enable	
Ruijie(config-if)# end	

VRRP

MSTP VRRP

A B

C D E

TPP

TPP

TPP

TTP

TTP

Ruijie# show tpp	TPP

```
Ruijie #show tpp
tpp state          : enable
tpp local bridge   : 00d0.f822.35ad
-----
```

Flash

```
Ruijie# copy flash:config.tex flash:tmp/
Ruijie# copy flash:con_bak.txt flash:config.text
```

Ruijie# dir	
Ruijie# dir <i>directory</i>	

```
Ruijie# dir
Ruijie# dir ../bak
```

Ruijie# makefs <i>dev devname fs fs_name</i>	<i>fs_name</i> dev

```

dev          MTD          JFFS2
Ruijie# makefs dev/dev/mtd/mtdblock/1 fs jffs2
          JFFS2          MTDBLOCK
```

Ruijie# mkdir <i>directoryname</i>	

BAK

```
Ruijie# mkdir bak
```

Ruijie# rename flash: <i>old_filename</i> flash: <i>new_filename</i>	<i>old_filename</i> <i>new_filename</i>

Ruijie# pwd	

Ruijie# del filename	

MNT

large.c

Ruijie# **del** *mnt/large.c*

Ruijie# rmdir <i>directoryname</i>	

MNT

Ruijie# **rmdir** *mnt*

CPU

13	0%	0%	0%	kswapd
14	0%	0%	0%	bdflush
15	0%	0%	0%	kupdate
16	0%	3%	1%	ll_mt
17	0%	0%	0%	ll main process
18	0%	0%	0%	bridge_relay
19	0%	0%	0%	dlx_task
20	0%	0%	0%	secu_policy_task
21	0%	0%	0%	dhcpa_task
22	0%	0%	0%	dhcpsnp_task
23	0%	0%	0%	igmp_snp
24	0%	0%	0%	mstp_event
25	0%	0%	0%	GVRP_EVENT
26	0%	0%	0%	rldp_task
27	0%	2%	1%	rerp_task
28	0%	0%	0%	reup_event_handler
29	0%	0%	0%	tpp_task
30	0%	0%	0%	ip6timer
31	0%	0%	0%	rtadvd
32	0%	0%	0%	tnet6
33	2%	0%	0%	tnet
34	0%	0%	0%	Tarptime
35	0%	0%	0%	gra_arp
36	0%	0%	0%	Ttcptimer
37	8%	1%	0%	ef_res
38	0%	0%	0%	ef_rcv_msg
39	0%	0%	0%	ef_inconsistent_daemon
40	0%	0%	0%	ip6_tunnel_rcv_pkt
41	0%	0%	0%	res6t
42	0%	0%	0%	tunrt6
43	0%	0%	0%	ef6_rcv_msg
44	0%	0%	0%	ef6_inconsistent_daemon
45	0%	0%	0%	imid
46	0%	0%	0%	nsmd
47	0%	0%	0%	ripd
48	0%	0%	0%	ripngd
49	0%	0%	0%	ospfd
50	0%	0%	0%	ospf6d
51	0%	0%	0%	bgpd
52	0%	0%	0%	pimd
53	0%	0%	0%	pim6d
54	0%	0%	0%	pdmd
55	0%	0%	0%	dvmrpd
56	0%	0%	0%	vty_connect
57	0%	0%	0%	aaa_task
58	0%	0%	0%	Tlogtrap

59	0%	0%	0%	dhcp6c
60	0%	0%	0%	sntp_recv_task
61	0%	0%	0%	ntp_task
62	0%	0%	0%	sla_daemon
63	0%	3%	1%	track_daemon
64	0%	0%	0%	pbr_guard
65	0%	0%	0%	vrrpd
66	0%	0%	0%	psnpsd
67	0%	0%	0%	igsnpd
68	0%	0%	0%	coa_recv
69	0%	0%	0%	co_oper
70	0%	0%	0%	co_mac
71	0%	0%	0%	radius_task
72	0%	0%	0%	tac+_acct_task
73	0%	0%	0%	tac+_task
74	0%	0%	0%	dhcpcd_task
75	0%	0%	0%	dhcps_task
76	0%	0%	0%	dhcpping_task
77	0%	0%	0%	dhcpc_task
78	0%	0%	0%	uart_debug_file_task
79	0%	0%	0%	ssp_init_task
80	0%	0%	0%	rl_listen
81	0%	0%	0%	ikl_msg_operate_thread
82	0%	0%	0%	bcmDPC

105	0%	0%	0%	ssp_ipmc_trap_task
106	0%	0%	0%	hw_err_snd_task
107	0%	0%	0%	rerp_packet_send_task
108	0%	0%	0%	idle_vlan_proc_thread
109	0%	0%	0%	cmic_pause_detect
110	1%	1%	1%	stat_get_and_send
111	0%	1%	0%	rl_con
112	75%	80%	90%	idle

		3		5	1	5
	CPU		LISR	HISR		CPU

'	No					
'	5Sec		5		CPU	
'	1Min		1		CPU	
		1		CPU		

<007A>TatE2C5B>Tj /TT1 1 2-0.0003 Tc 4.251 0 Td (CPU[.337 25184557284D215E0 Td>63<0 Td (5)Tj /C2

Oct 20 15:47:01 %SYSCHECK-5-CPU_USING_RATE: The CPU using rate has down!

show memory

Ruijie# show memory	

Ruijie

show memory

```
Ruijie#show memory
Buddy System info ( Active: 4, inactive: 2, free: 19958 ) :
Zone : DMA
watermarks : min 429, low 1716, high 2574
watermarks : min 0, low 0, high 0
watermarks : min 0, low 0, high 0
Totalpages : 25780(103120KB), freepages : 19958(79832KB)
System Memory Statistic:
Total Objects : 89128, Objects Using size 20428KB.
System Total Memory : 128MB, Current Free Memory : 81066KB
slabinfo - (statistics)
=====
cache                |objects                |slabs
|statistics
-----
memory-cache-name  |active  number  size  |active number
order |high  alloc  grown  reaped  error
=====
kmem_cache          86      87      132    3      3      1
86    86    3    0    0
ssp_rx_packet_pool 2044    2044    2048   1022   1022   1
2044  2044  1022  0    0
ssp_emergen_mem     0        1024    512    0      128    1
```

1024	1024	128	0	0					
tcp_tw_bucket			0	0	224	0	0	1	
0	0	0	0	0					
tcp_bind_bucket			1	59	32	1	1	1	
1	1	1	0	0					
tcp_open_request			0	0	96	0	0	1	
0	0	0	0	0					
ip_mrt_cache			0	0	576	0	0	1	
0	0	0	0	0					
tuncache			0	0	132	0	0	1	
0	0	0	0	0					
tsfnpool			0	0	12	0	0	1	
0	0	0	0	0					
ARP table			0	0	132	0	0	1	
0	0	0	0	0					
bst_pool			9	72	20	1	1	1	
9	9	1	0	0					
sock			91	91	1184	7	7	4	
91	131	7	0	0					
clipri			0	0	32	0	0	1	
0	0	0	0	0					
clieol			1	5	3072	1	1	4	
2	81	1	0	0					
clipsr			0	8	512	0	1	1	
6	37864	1	0	0					
waitqueue_block			0	0	20	0	0	1	
0	0	0	0	0					
hookbait_pool			140	177	32	3	3	1	
140	140	3	0	0					
skb_head			34	45	224	3	3	1	
34	34	3	0	0					
long_sk_data			0	0	10048	0	0	4	
0	0	0	0	0					
sk_data			1	3	2432	1	1	2	
1	1	1	0	0					
blkdev_requests			1024	1050	96	35	35	1	
1024	1024	35	0	0					
jffs2_inode_cache			37	67	24	1	1	1	
37	37	1	0	0					
jffs2_node_frag			3598	3654	28	58	58	1	
3603	3611	58	0	0					
jffs2_raw_node_ref			7445	7488	16	96	96	1	
7445	7445	96	0	0					
jffs2_tmp_dnode			0	3640	36	0	65	1	
3601	3635	65	0	0					
jffs2_raw_inode			0	39	68	0	1	1	

1	11	1	0	0						
jffs2_raw_dirent			0		53	40	0	1	1	
1	3	1	0	0						
jffs2_full_dnode			3602		3666	16	47	47	1	
3611	3637	47	0	0						
jffs2_i			9		10	768	2	2	1	
10	11	2	0	0						
devfsd_event			0		0	20	0	0	1	
0	0	0	0	0						
file_lock_cache			0		0	88	0	0	1	
0	0	0	0	0						
dnotify_cache			0		0	20	0	0	1	
0	0	0	0	0						
kiobuf			0		0	64	0	0	1	
0	0	0	0	0						
cdev_cache			0		0	160	0	0	1	
0	0	0	0	0						
bdev_cache			1		20	160	1	1	1	
1	1	1	0	0						
mnt_cache			9		40	64	1	1	1	
9	11	1	0	0						
inode_cache			128		132	640	22	22	1	
128	153	22	0	0						
dentry_cache			141		144	128	6	6	1	
141	168	6	0	0						
filp			101		120	128	5	5	1	
101	101	5	0	0						
names_cache			0		2	4096	0	2	1	
2	69	2	0	0						
buffer_head			0		0	96	0	0	1	
0	0	0	0	0						
fs_cache			87		118	32	2	2	1	
93	96	2	0	0						
files_cache			87		99	416	11	11	1	
93	96	11	0	0						
mc_bitmap			176		180	128	6	6	1	
176	176	6	0	0						
mdbg_cache			2883		3030	16	15	15	1	
2883	6492	15	0	0						
size-33554432(DMA)			0		0		33554432	0	0	
8192	0	0	0	0	0					
size-33554432			0		0		33554432	0	0	
8192	0	0	0	0	0					
size-16777216(DMA)			0		0		16777216	0	0	
4096	0	0	0	0	0					
size-16777216			0		0		16777216	0	0	

4096	0	0	0	0	0					
size-8388608(DMA)			0		0	8388608	0		0	
2048	0	0	0	0	0					
size-8388608			0		0	8388608	0		0	
2048	0	0	0	0	0					
size-4194304(DMA)			0		0	4194304	0		0	
1024	0	0	0	0	0					
size-4194304			0		0	4194304	0		0	
1024	0	0	0	0	0					
size-2097152(DMA)			0		0	2097152	0		0	
512	0	0	0	0	0					
size-2097152			0		0	2097152	0	0		512
0	0	0	0	0						
size-1048576(DMA)			0		0	1048576	0		0	
256	0	0	0	0	0					
size-1048576			0		0	1048576	0	0		256
0	0	0	0	0						
size-524288(DMA)			0		0	524288	0	0		128
0	0	0	0	0						
size-524288			0		1	524288	0	1		128
1	1	1	0	0						
size-262144(DMA)			0		0	262144	0	0		64
0	0	0	0	0						
size-262144			7		7	262144	7	7		64
7	7	7	0	0						
size-131072(DMA)			0		0	131072	0	0		32
0	0	0	0	0						
size-131072			18		18	131072	18	18		32
18	18	18	0	0						
size-65536(DMA)			0		0	65536	0	0		16
0	0	0	0	0						
size-65536			34		39	65536	34	39		16
39	44	39	0	0						
size-32768(DMA)			0		0	32768	0	0		8
0	0	0	0	0						
size-32768			56		57	32768	56	57		8
57	64	57	0	0						
size-16384(DMA)			0		0	16384	0	0		4
0	0	0	0	0						
size-16384			72		74	16384	72	74		4
74	77	74	0	0						
size-8192(DMA)			0		0	8192	0	0		2
0	0	0	0	0						
size-8192			24		24	8192	24	24		2
24	34	24	0	0						
size-4096(DMA)			0		0	4096	0	0		1

```

0      0      0      0      0
size-4096          148      148      4096      148      148      1
148    2962    148    0      0
size-2048(DMA)    0          0          2048      0          0          1
0      0      0      0      0
size-2048          63          64          2048      32          32          1
63     403     32     0      0
size-1024(DMA)    0          0          1024      0          0          1
0      0      0      0      0
size-1024          188         188         1024      47          47          1
188    473     47     0      0
size-512(DMA)     0          0          512       0          0          1
0      0      0      0      0
size-512          160         161         512       23          23          1
160    440     23     0      0
size-256(DMA)     0          0          256       0          0          1
0      0      0      0      0
size-256          92          104         256       8           8           1
95     1244    8      0      0
size-128(DMA)     0          0          128       0          0          1
0      0      0      0      0
size-128          248         288         128       11          12          1
272    787     12     0      0
size-64(DMA)      0          0          64        0          0          1
0      0      0      0      0
size-64           16519        16560        64        414         414         1
16534  17990  414    0      0
size-32(DMA)      0          0          32        0          0          1
0      0      0      0      0
size-32           49854        49914        32        845         846         1
49866  90468  846    0      0
=====

```

1. Buddy System

Active			
Inactive			
Free			
Zone		DMA	Normal
		256M	DMA
Zone	watermarks 1	DMA	DMA

DMA		min	
		low	
		high	
	watermarks 2	DMA	DMA
	watermarks 3		
Zone Normal	watermarks 1	Normal 256M	Normal
	watermarks 2		
Totalpages			
Freepages			

2.

Total Objects	
Object using size	
System Total Memory	
System Free Memory	

3.

Cache	Memory-cache-name	
Objects	Active	
	Number	
	Size	Byte
Slabs	active	slab
	number	slab
	order	slab
Statisti	High	

CS	Alloc	
	Grown	slab
	Reaped	slab
	Error	

Threshold

CPU

CLI

MIB

CPU

CPU
log

CPU

MIB

log

MIB

CPU	90	100
	90	100

CPU

CPU

Step 1 Ruijie# **configure terminal**

Step 2 Ruijie(config)# **threshold set cpu 90**

CPU 80 90 50
80

Ruijie# **configure terminal**

Enter configuration commands, one per line. End with CNTL/Z.

Ruijie(config)#**threshold set cpu member 1 80 90**

Ruijie(config)#**threshold set temperature member 1 60 80**

show threshold

Ruijie#**show threshold cpu**

Device	Warning	Critical
--------	---------	----------

Member 1:	80	90
-----------	----	----

Ruijie#**show threshold memory**

Device	Warning	Critical
--------	---------	----------

Member 1:	90	100
-----------	----	-----

Ruijie#**show threshold temperature**

Device	Warning	Critical
--------	---------	----------

Member 1:	60	80
-----------	----	----

CPU

UP DOWN

VTY

FLASH

<priority> seq no: timestamp sysname
%ModuleName-severity-MNEMONIC: description

< > - -
8

<189> 226:Mar 5 02:09:10 S3760 %SYS-5-CONFIG_I: Configured
from console by console

r

Syslog Server

FLASH Syslog

Ruijie(config)# no logging count	
Ruijie(config)# logging count	

Ruijie(config)# no service sequence-numbers	
Ruijie(config)# service sequence-numbers	

Ruijie(config-line)# logging synchronous	
Ruijie(config)# no logging synchronous	

Ruijie(config)# logging rate-limit <i>rate</i>	

Ruijie(config)# no logging rate-limit	
--	--

Ruijie(config)# logging console <i>level</i>	
Ruijie(config)# logging monitor <i>level</i>	VTY (telnet)
Ruijie(config)# logging buffered <i>[buffer-size level]</i>	
Ruijie(config)# logging file flash:filename <i>[max-file-size] [level]</i>	FLASH
Ruijie(config)# logging trap <i>level</i>	Syslog Server

8

Emergencies	0	
Alerts	1	
Critical	2	
Errors	3	
warnings	4	
Notifications	5	

6

7

VTY

7

Syslog Server

6

7

FLASH

6

show logging

Syslog Server

Ruijie(config)# logging facility <i>facility-type</i>	
Ruijie(config)# no logging facility <i>facility-type</i>	

Numerical Code	Facility
0	kernel messages
1	user-level messages
2	mail system
3	system daemons
4	security/authorization messages
5	messages generated internally by syslogd
6	line printer subsystem
7	network news subsystem
8	UUCP subsystem
9	clock daemon
10	security/authorization messages
11	FTP daemon
12	NTP subsystem
13	log audit
14	log alert
15	clock daemon
16	local use 0 (local0)
17	local use 1 (local1)

```
18          local use 2 (local2)
19          local use 3 (local3)
20          local use 4 (local4)
21          local use 5 (local5)
22          local use 6 (local6)
23          local use 7 (local7)
```

23

Syslog Server

Log IP Log

Log	IP	Log
Ruijie(config)# logging source interface <i>interface-type interface-number</i>		

Ruijie(config)#

Ruijie# clear logging	
Ruijie# more flash: <i>filename</i>	FLASH

r