



2.



1

RG-S6510-48VS8CQ-R

25G/100G

8 100G

10/25G

RG-S6510-48VS8CQ-R

48 25G

RG-S6510-48VS8CQ-R

	100G QSFP28	25G/10G SFP28	10GBase-T			
RG-S6510-48VS8CQ-R	8	48	-	-	3+1	1+1

SFP28

25G/10Gbase-R

1000base-X

QSFP28

100G/40G

4x25G/4x10G

1.1 RG-S6510-48VS8CQ-R

	RG-S6510-48VS8CQ-R	
CPU	1.5GHz	
BOOT ROM	8MB	
FLASH Memory	8GB	
SDRAM	DDR4 4GB	8GB
	4	3
	3+1	
	M6510-FAN-R	



locator
SFP28

RG-S6510-48VS8CQ-R	100G QSFP28	25G SFP28
--------------------	-------------	-----------

1-3 RG-S6510-48VS8CQ-R

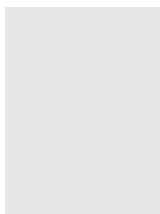



RG-S6510-48VS8CQ-R

USB		Universal Serial BUS		USB	
USB		USB		USB	
RG- S6510-48VS8CQ-R		Console		USB	
Console		RS-232		RJ45	
MGMT		RJ45		USB	
SFP28	48	25G SFP28	AOC		10GBASE-X
QSFP28	8	100G QSFP28	AOC		4x25G
RG-S6510-48VS8CQ-R		18KG			

RG-S6510-48VS8CQ-R

RG-S6510-48VS8CQ-R

1 1

1 1

2

1

RG-S6510-48VS8CQ-R

0-45

RG-S6510-48VS8CQ-R

Status

		Status		

		M6510-FAN-R
		30CFM
		23000RPM
		14.16W
		0.20KG
		46.4 * 131.9 * 81.2 W * D * H mm

1.2.2 RG-PA550I-R

RG-PA550I-R RG-S6510-48VS8CQ

RG-S6510-48VS8CQ

RG-PA550I-R

RG-PA550I-R

1-6 RG-PA550I-R

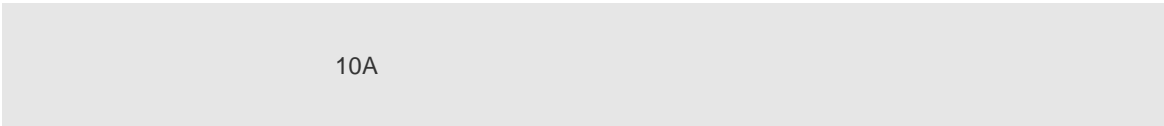

10A

		1HZ	1 PS off 12VBS 2
			1 fan 2 AC
		1HZ	

	RG-PA550I-R AC	RG-PA550I-R HVDC
	100V-240V~ 50/60Hz	240VDC

90-264V~ 47-63Hz

180-310VDC

2

2.1

RG-S6510-48VS8CQ-R

2.1.1

3

1M

2.1.2

2.1.3

2.1.4



2.2

RG-S6510-48VS8CQ-R

2.2.1

RG-S6510-48VS8CQ-R

2.2.4

0.5μ m	/ m ³	3.5× 10 ⁶
5μ m	/ m ³	3× 10 ⁴

	(mg/m ³)	(mg/m ³)
SO ₂	0.3	1.0
H ₂ S	0.1	0.5
NO ₂	0.5	1.0
Cl ₂	0.1	0.3

30

2.2.5

RG-S6510-48VS8CQ-R

2.2.6 EMI

2.3

2.4

2.5

2-2

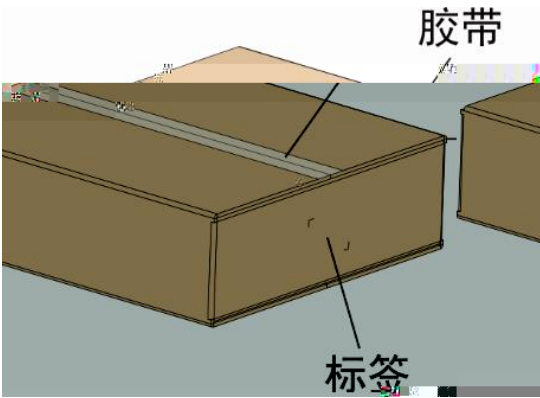

2-3

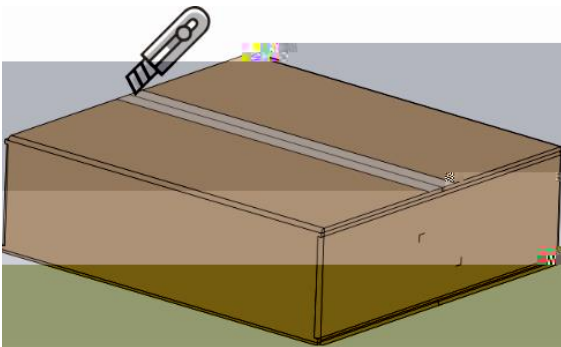

2-4

1

安装附件盒

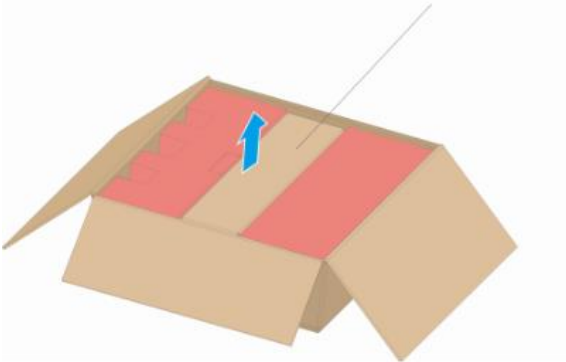

2-5

2

安装附件盒

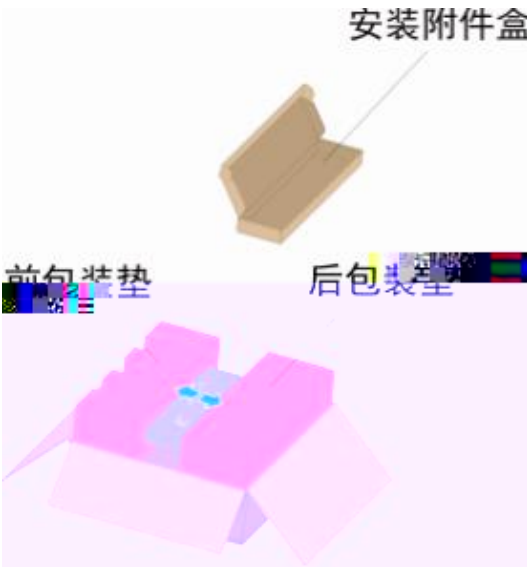

2-6

内包装垫

包装胶袋

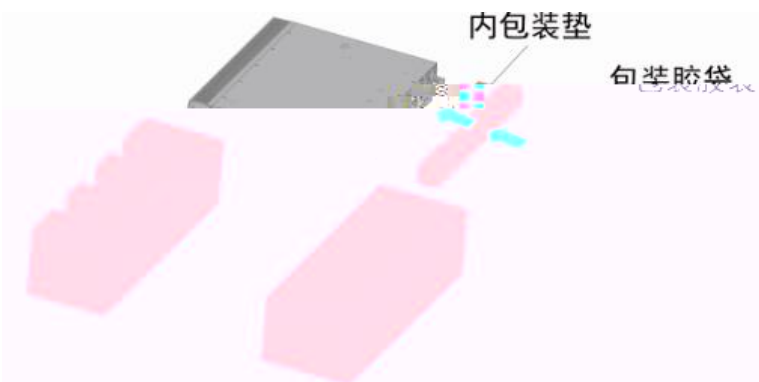

3.3

RG-S6510-48VS8CQ-R

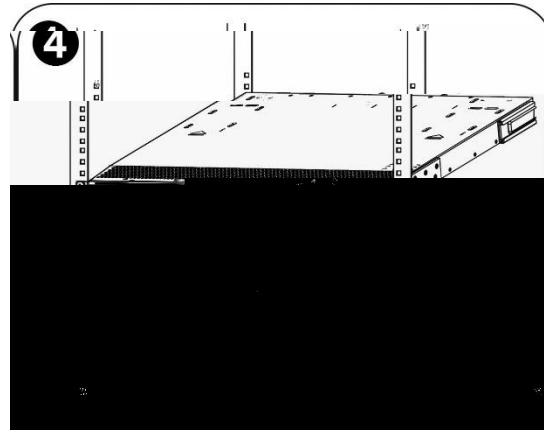
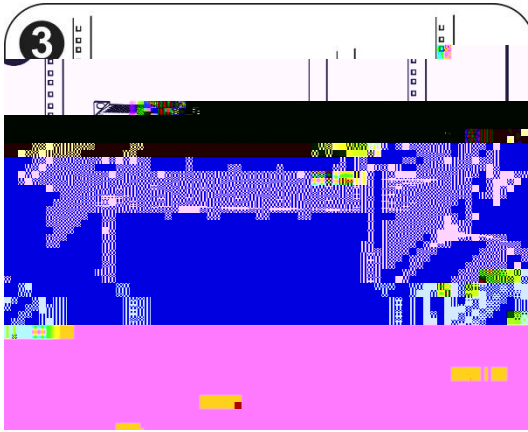
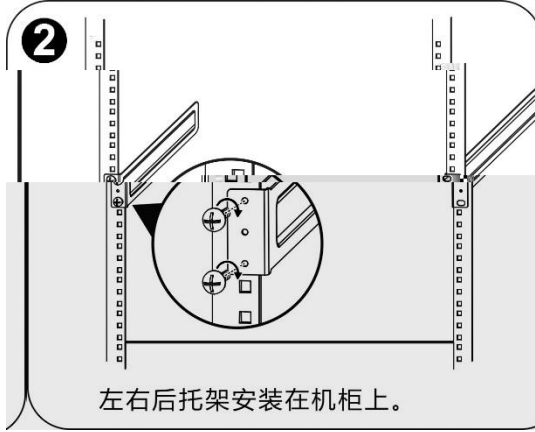

800mm 1200mm

2)

3.7

1)

2)

" "

3-6 RG-PA550I-R

RG-PA550I-R

3.8

" 3.4 "

3-8

SFP+
QSFP+/QSFP28

3.8.1

SFP+

/ ¢

3-9 SFP+

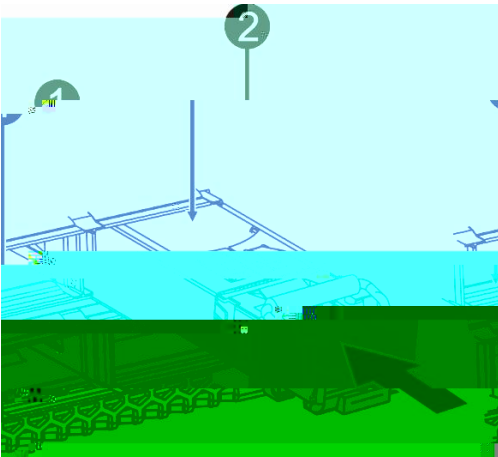

SFP+
SFP+

2) SFP+

3) " Link/ACT"

SFP+

3-9

SFP+

SFP+

SFP+

1)

2) SFP+

SFP+

3-10 SFP+



2) 40G QSFP+

3) " Link/ACT"

QSFP+

3-11

QSFP+

QSFP+

QSFP+

1

2 QSFP+

3-12 QSFP+

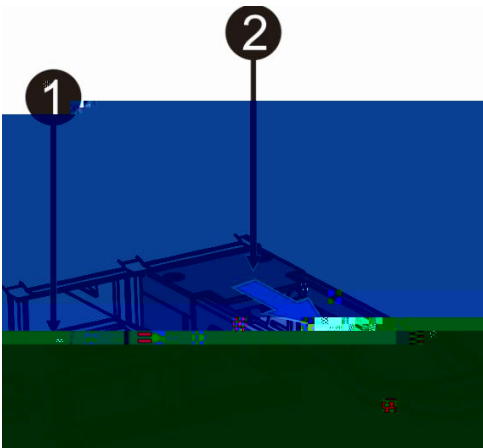

QSFP+

QSFP+

3.8.3 100G QSFP28

100G QSFP28

3-8

100G QSFP28

1)

" "

3-13 QSFP28

QSFP28
QSFP28

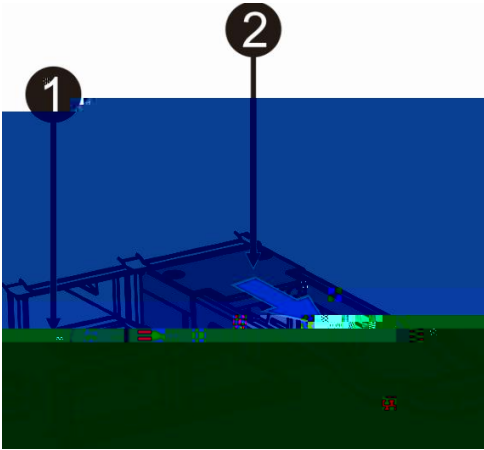

QSFP28
QSFP28

3.9

RJ-45

Console

DB9

9600

8

1

3.10

- 1) RJ45 MGMT
- 2) ,
- 3) RJ45

3.11

- 1)
- 2)
- 3)

3.12

4

4.1

PC Console 4-1
4-1

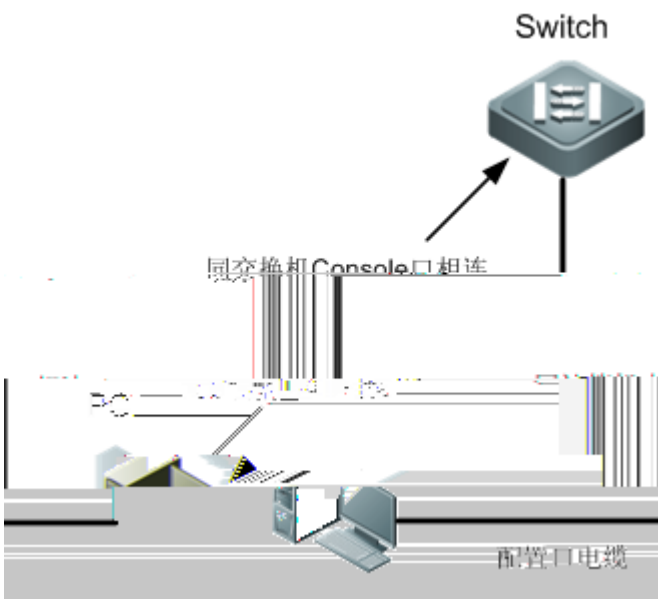

- 1) DB-9 PC
- 2) RJ45 Console

PC	PC	Windows3.1	Terminal	Windows 95/98/NT/2000/XP
		9600	8	1

1) - - - - 4-2
4-2

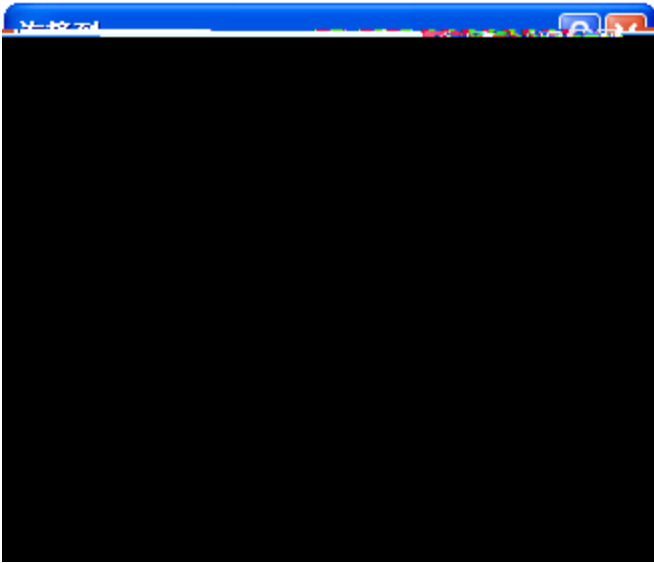

4) < > 4-5

8 1

9600

4-5

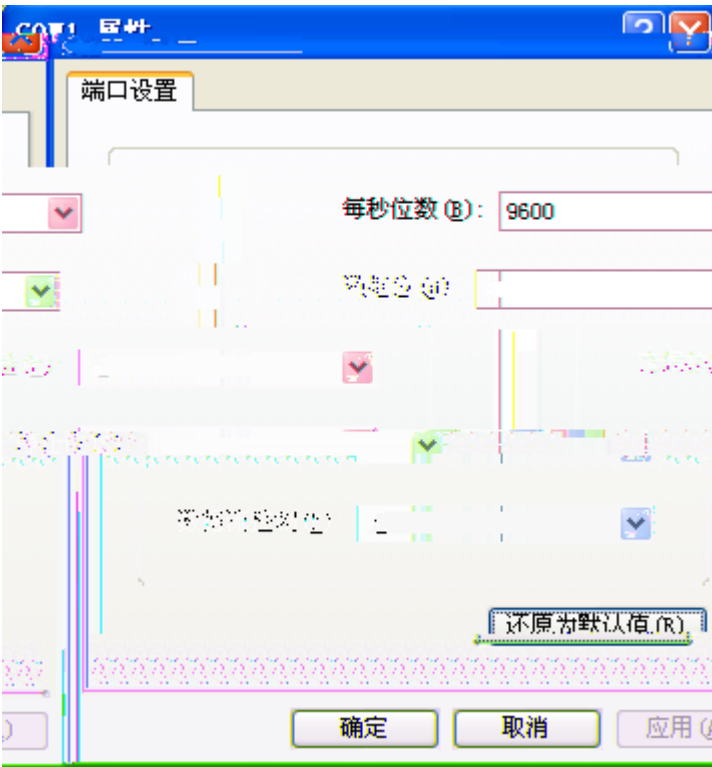

5) < > 4-6

4-6

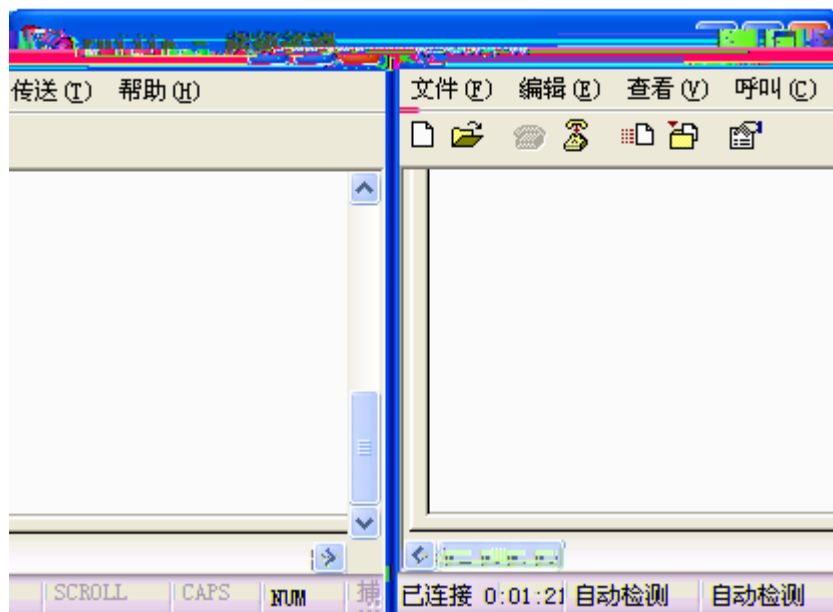

4.2

PC

5

5.1

RG-S6510-48VS8CQ-R

RG-S6510-48VS8CQ-R

RG-S6510-48VS8CQ-R

2

Status

3

7 **link**

link

1

2

1310nm

1550nm

3

4

A — 40G 100G

SFP+

	(nm)			(MHz· km)		(dbm)		(dbm)	
						min	max	min	max
XG-SFP-SR-MM850	850	(Lc)	62.5	200	33m	-5	-1	-7.5	0.5
				160	26m				
			50	2000	300m				
				500	82m				
				400	66m				

XG-SFP-LR

	(nm)		()	(MHz· km)		DDM (Yes/No)	(dBm)	(dBm)
100G-QSFP-SR4-MM850	850	(MPO)	50	4700	150m (OM4)	Yes	-8.4to 2.4 (Perlane)	-10.3to 2.4 (Perlane)
100G-QSFP-LR4-SM1310	1301	LC	9	N/A	10km	Yes	-4.3to 4.5 (Perlane)	-10.6 to 4.5 (Perlane)

S6510

B —

C-1

接地、极性检测指示灯，该
红灯亮起可能表明接线错误（接
地线，或火、零线接反），
请检查您的供电情况。



PE

PE

PE

1)

2)

3)

C —

RG-S6220-H

19

D-3

mm	mm
10	80~150
10~30	150~200
30	200~300

