

RG-CT5540H

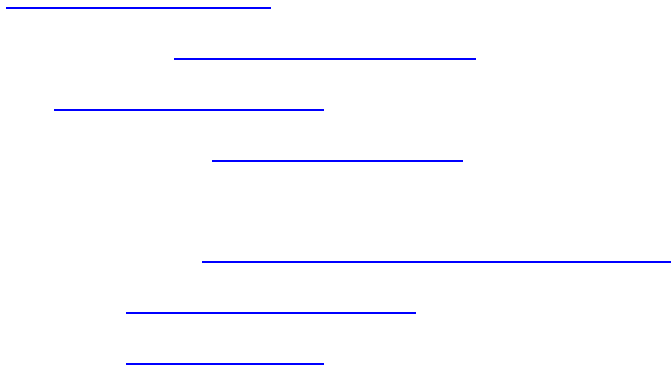



.....

.....

5

.....



.....

.....

1.1 1

1.2 2

1.3 2

.....

2.1 4

2.2 5

2.3 5

.....

3.1 5

3.2 ()..... 6

3.3 9

3.4 10

.....

.....

.....

1

1-1 RG-CT5540H

1.1



1-1

--	--	--

1.2

1-2 RG-CT5540H

(1)

(2) **USB 3.0**

(3)

(4)

(5) **CMS**

(6) **USB 2.0**

(7)

2.2

2-1



2.3

3

3.1

3-1

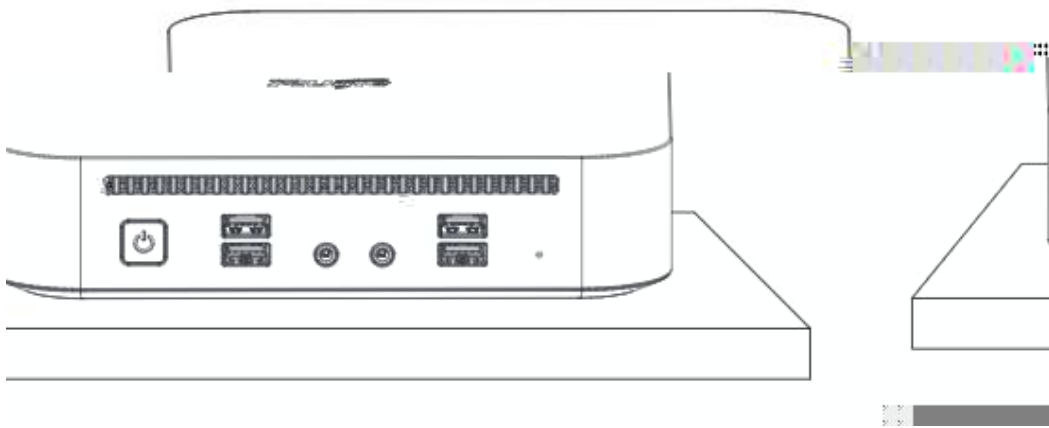



3-4

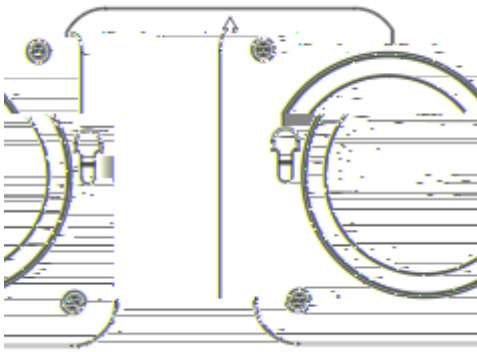

(2)

3-5

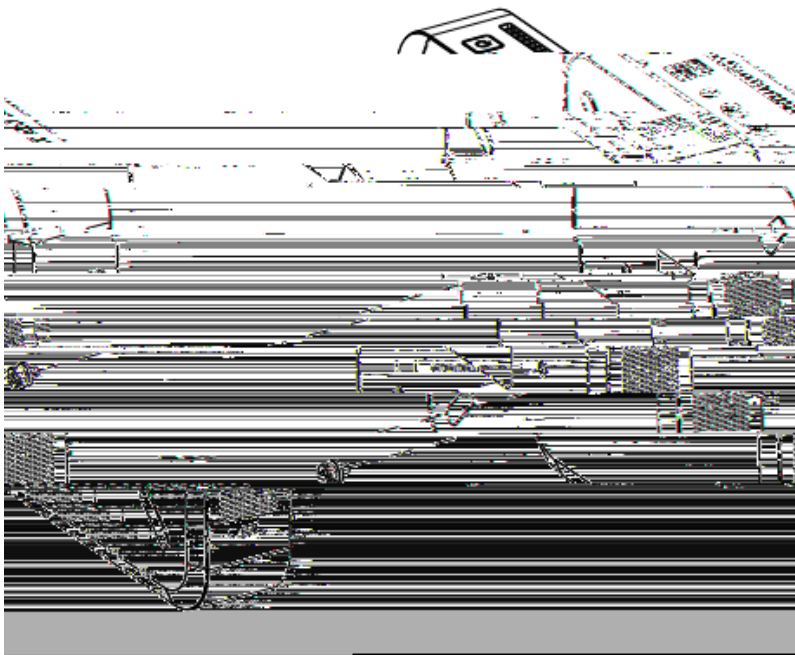

(3)

3-6

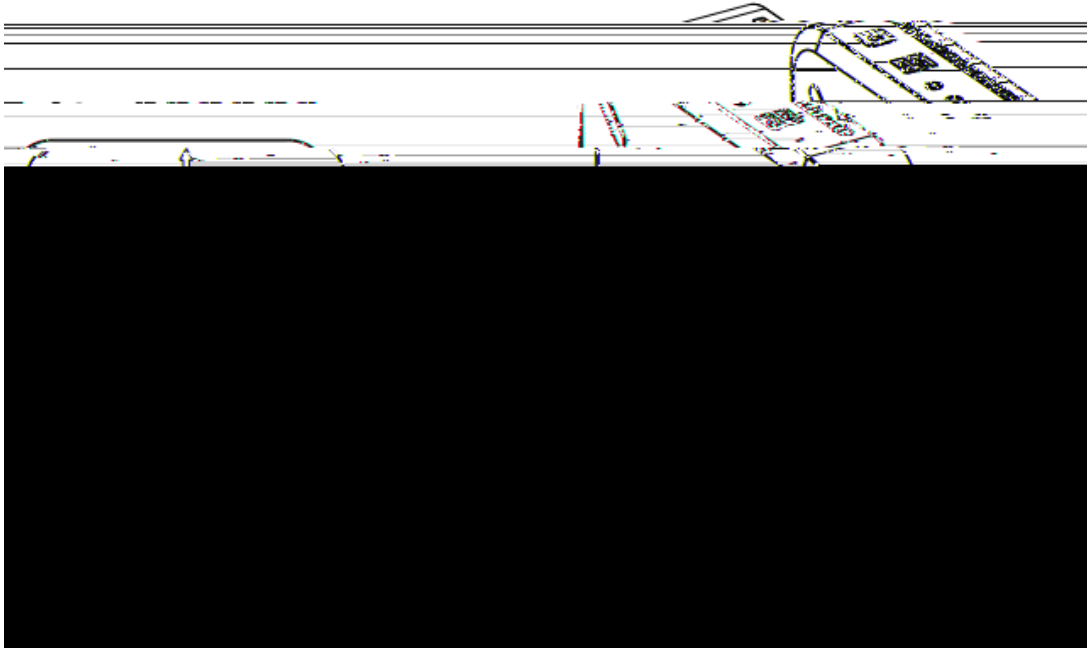

(4)

3-7

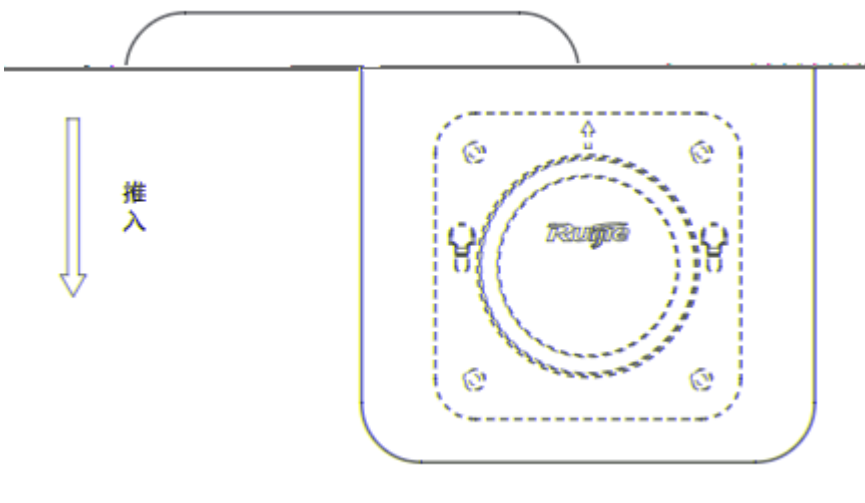

M4

1mm

$L=L_2+5\text{mm}$ L2

$L= 1+5 \text{ mm}=6\text{mm}$

M4X6mm



3-8

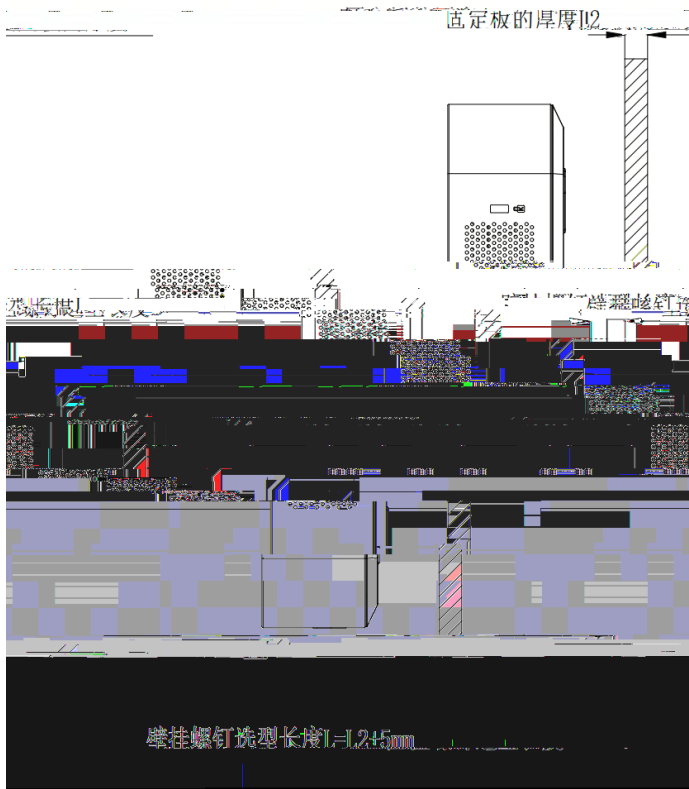

3.3

3-9



3.4

4

4-1

进入报修页面





5



6

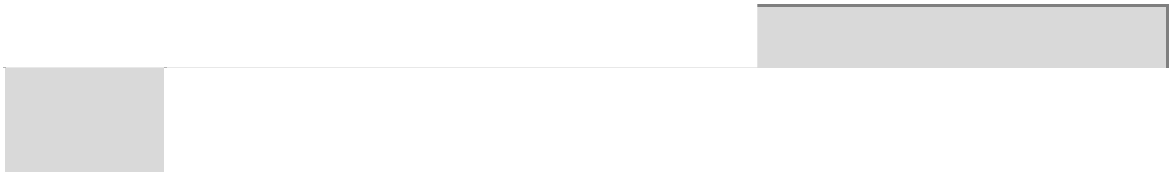

x				"	"	